

PRO
DECOR

Inspired by Life

Griffkollektion

Handle Collection

Collection de poignées

Greepcollectie



INTERFER

Technik für Möbel

Hettich

ProDecor – Inspired by Life

Übersicht | Summary | Vue d'ensemble | Overzicht

Zeichenerklärung

Key

Légende

Verklaring van de tekens

 Länge oder Breite
Length or width
Longueur ou largeur
Lengte of breedte

 Höhe
Height
Hauteur
Hoogte

 Bohrabstand
Hole distance
Distance d'écartement
Boorafstand

 Verpackungseinheit
Packaging unit
Unité d'emballage
Verpakkingseenheid

 Zum Ablängen
Cut to size
À recouper
Om op maat te maken

Alle Maße sind in mm angegeben
All measurements in mm
Toutes les mesures sont indiquées en mm
Alle afmetingen zijn in mm aangegeven

Alle Gewinde sind metrisch
All threads are metric
Tous les pas de vis sont métriques
Alle schroefdraden zijn metrisch

Wir empfehlen zum Festziehen des Griffes keine elektrisch betriebenen Werkzeuge zu verwenden.
We do not recommend using power tools to tighten the handle screws.

Nous vous recommandons de ne pas utiliser des outils électriques pour serrer la poignée à fond.

Voor het vastdraaien van de greep adviseren wij geen elektrisch werkend gereedschap te gebruiken.

Alle Naturmaterialien können in Farbe und Struktur von den Abbildungen abweichen.
All natural materials may vary in colour and structure from those depicted.

Tous les matériaux en matière naturelle peuvent être légèrement différents en finition ou en couleur par rapport à la photographie.
De kleur en de structuur van het natuurlijke materiaal kunnen afwijken van de afbeeldingen.

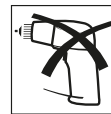

Reinigungsmittel für Griffe und Knöpfe:

- ▶ Weiches, fusselfreies Tuch und wasserlösliche milde Reinigungsmittel wie Flüssig- oder Neutralseife verwenden.
- ▶ Keine Scheuermittel/-schwämme, Nitro-Verdünnungen oder reizende/ätzende Chemikalien verwenden, diese können die Oberflächen langfristig schädigen!
- ▶ Generell sollten Flecken so schnell wie möglich entfernt werden, um ein Einziehen in die Oberflächen zu vermeiden.

Cleaning products for handles and knobs:

- ▶ Please use a soft, lint free cloth and mild water-soluble detergents such as liquid or neutral soap.
- ▶ Do not use any abrasive cleaners, scouring pads, cellulose thinners or irritant/corrosive chemicals as these may damage the surface over time!
- ▶ Marks should always be removed as quickly as possible to prevent them from staining the surface.

Détergent pour poignées et boutons :

- ▶ Utiliser un chiffon doux et non pelucheux avec un détergent doux et soluble dans l'eau tel que du savon liquide ou neutre.
- ▶ Ne pas utiliser de détergents abrasifs, ni d'éponges à récurer, ni de diluants pour laque cellulosique, ni de produits chimiques irritants/corrosifs qui risquent d'endommager à long terme les surfaces !
- ▶ D'une manière générale, il faut effacer le plus vite possible les taches pour éviter qu'elles ne s'incruster dans les surfaces.

Reinigungsmittelen voor grepen en knoppen:

- ▶ Gebruik een zachte, niet pluizende doek en in water oplosbare, milde schoonmaakmiddelen als vloeibare zeep of groene zeep.
- ▶ Gebruik geen schuurspoonsjes/schurende schoonmaakmiddelen, nitroverduunners of bijtende/irriterende chemicaliën, hierdoor zouden de oppervlakken op termijn beschadigd raken!
- ▶ Vlekken moeten altijd zo snel mogelijk worden verwijderd, zodat deze niet in het oppervlak kunnen dringen.



Stilwelt NEW MODERN | NEW MODERN style world | L'univers de style NEW MODERN |
Stijlrichting NEW MODERN

Übersicht | Summary | Vue d'ensemble | Overzicht
Griffe und Knöpfe | Handles and knobs | Poignées et boutons | Grepen en knoppen

4 - 5
6 - 39



Stilwelt DELUXE | DELUXE style world | L'univers de style DELUXE | Stijlrichting DELUXE

Übersicht | Summary | Vue d'ensemble | Overzicht
Griffe und Knöpfe | Handles and knobs | Poignées et boutons | Grepen en knoppen

40
42 - 54



Stilwelt ORGANIC | ORGANIC style world | L'univers de style ORGANIC | Stijlrichting ORGANIC

Übersicht | Summary | Vue d'ensemble | Overzicht
Griffe und Knöpfe | Handles and knobs | Poignées et boutons | Grepen en knoppen

56 - 57
58 - 79



Stilwelt FOLK | FOLK style world | L'univers de style FOLK | Stijlrichting FOLK

Übersicht | Summary | Vue d'ensemble | Overzicht
Griffe und Knöpfe | Handles and knobs | Poignées et boutons | Grepen en knoppen

80 - 81
82 - 103



Touch-in
Griffe | Handles | Poignées | Grepen

104
105 - 109

Zubehör, Arbeitshilfen | Accessories, work assistants | Accessoires et aides pour la réalisation |
Toebehoren, verwerkingshulpmiddelen
Übersicht nach Materialien | Summary by materials | Vue d'ensemble en fonction des matériaux |
Overzichtelijk gesorteerd op materiaal
Sachwortverzeichnis | Index | Liste des termes clés | Trefwoordenregister
Bestellnummern | Order numbers | Références | Bestelnummers

110 - 121
122 - 126
127
128 - 131



Raumgestaltung ist der Ausdruck persönlichen Stils. Deshalb gibt es die vier ProDecor Stilwelten: für Wohnen mit Persönlichkeit.

Interior design is an expression of personal style. This is why there are four ProDecor style worlds: for homes with personality.

NEW MODERN



DELUXE



Technik. Transparenz. Sachlichkeit.

NEW MODERN beeindruckt durch seine klare, futuristische Formensprache und coole Haptik. Die meisterhafte Vollen- dung puristischer Möbelfronten.

Technology. Transparency. Practicality.

NEW MODERN impresses with its clear cut, futuristic style and cool touch. Purist looking furniture fronts in masterful perfection.

Technologie. Transparence. Sobriété.

NEW MODERN impressionne par ses formes claires et futuristes ainsi que par sa finition au toucher sympa- thique. C'est l'accomplissement magistral des façades de meubles aux lignes épurées.

Techniek. Transparentie. Zakelijkheid.

NEW MODERN maakt indruk door zijn heldere, futuristische vormtaal en coole, voelbare eigenschappen. De meesterlijke volmaaktheid van puristische fronten.

Sinnlich wohnen – mit einem Hauch Luxus:

Schillernde Metalle und majestätische Farben prägen die Stilwelt DELUXE. Das kraftvolle Griffdesign zaubert sinnliche Atmosphäre in den Raum und verführt zur Berührung ...

Homes that speak to the senses – with a touch of luxury:

Shimmering metals and majestic colours define the DELUXE style world. The powerful handle design conjures an ambience that pleases the senses, extending an irre- sistible invitation to touch ...

L'habitat qui éveille tous les sens – avec un souffle de luxe :

les métaux scintillants et les couleurs majestueuses marquent l'univers du style DELUXE. Le design puissant des poignées crée une atmosphère dans la pièce qui éveille tous les sens et donne envie de toucher ...

Wonen met gevoel – en een vleugje luxe:

Stijlwereld DELUXE wordt gekenmerkt door glinsterende metalen en majestueuze kleuren. Het krachtige greep- design zorgt voor een zinnelijke sfeer in de ruimte en vraagt erom aangeraakt te worden...

L'aménagement intérieur reflète le style de chacun. C'est pourquoi il existe quatre univers de style ProDecor : pour habiter dans un environnement personnalisé

Een interieur is de expressie van een persoonlijke stijl. Daarom heeft ProDecor vier stijlrichtingen: voor wonen met persoonlijkheid.

ORGANIC



FOLK



Die Idylle der unberührten Natur.

Diese Kollektion lebt von organischen Formen und naturnahen, rauen Oberflächen. Wohnen mit natürlichem Charme? Willkommen in der ORGANIC Stilwelt!

The idyll of unspoiled nature.

This collection is fired by organic shapes and natural looking, rough feeling finishes. Want to live with nature's charm? Welcome to the world of ORGANIC style!

L'idylle de la nature intacte.

Cette collection vit des formes organiques et des surfaces rugueuses écologiques. Peut-on habiter dans un cadre au charme naturel ? Oui, c'est possible. Bienvenue dans l'univers du style ORGANIC !

De idylle van de ongerepte natuur.

Deze collectie floreert door organische vormen en natuurgetrouwe, ruwe oppervlakken. Wonen met natuurlijke charme? Welkom in de wereld van ORGANIC!

Möbelgriffe, die Geschichten erzählen.

Traditionelle Formen und Farben. Üppige Muster und weiche Oberflächen, die man gerne berührt. Raffinierte Used-Optik strahlt sympathische Wärme aus. FOLK ist pure Freude. Auch für Ihre Kunden.

Furniture handles that tell stories.

Traditional shapes and colours. Opulent patterns and soft finishes you want to touch. Ingeniously crafted used looks exude appealing warmth. FOLK is pure joy. For your customers too.

Des poignées de meubles qui racontent des histoires.

Des formes et des couleurs traditionnelles. Des motifs exubérants et des surfaces douces que l'on touche volontiers. L'aspect usagé raffiné donne à chaque pièce une ambiance chaleureuse sympathique. FOLK, c'est le bonheur à l'état pur. Également pour vos clients.

Meubelgrepen die een verhaal vertellen.

Traditionele vormen en kleuren. Weelderige motieven en zachte oppervlakken die graag worden aangeraakt. Een geraffineerde used look straalt sympathieke warmte uit. FOLK is pure vreugde, ook voor uw klanten.

NEW MODERN



6 Tempe



6 Vigilia



7 Apua



7 Nubia



8 Torino



8 Velitra



9 Capua



9 Imperia



9 Evisa



10 Zenga



11 Bermeo



11 Nursia



12 Cheam



12 Tornea



13 Anzio



13 Arnun



14 Aratti



14 Aosta



15 Clivia



16 Alvito



16 Pola



16 Guarani



16 Narona



17 Hale



18 Salvia



19 Kervo



19 Fermo



20 Stabia



21 Rovigo



22/23 Canis L



24/25 Canis C



26 Celista



26 Genoa



27 Rialto



27 Messina



28 Milo



28 Venusia



29 Trani



29 Ticinum



30 Narni



30 Empoli



35 Genzone



38 Agrinum



31 Lamezia



35 Capris



38 Monacum



32 Lindavia



36 Nidum



39 Danum



32 Lutetia



36 Spira



39 Sion



32 Eslinga



37 Misnia



39 Spalatum



32 Seveso



37 Apolda



33 Mosena



38 Novae



34 Riaza



38 Onex

NEW MODERN

Tempe



Edelstahl gebürstet
Brushed stainless steel
Inox brossé
Roestvrij staal geborsteld

| | |
|-----------|----|
| | ☐ |
| 9 191 722 | 10 |

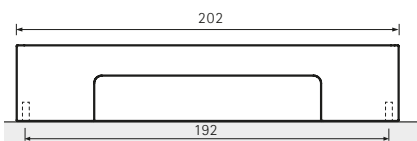

Vigilia



1 Verchromt glanz
Bright chrome plated
Chromé brillant
Verchromd glans



2 Edelstahl Optik gebürstet
Brushed stainless steel look
Aspect inox brossé
Roestvrij staal finish geborsteld

| | | |
|---|-----------|----|
| | | ☐ |
| 1 | 9 065 627 | 25 |
| 2 | 9 065 628 | 25 |

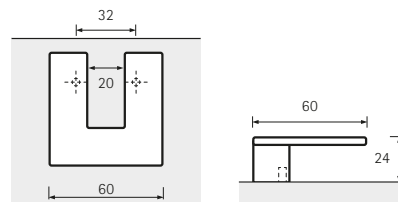

Apua



Edelstahl Optik gebürstet
Brushed stainless steel look
Aspect inox brossé
Roestvrij staal finish geborsteld

Nubia



1 Verchromt glanz
Bright chrome plated
Chromé brillant
Verchromd glans



2 Edelstahl Optik gebürstet
Brushed stainless steel look
Aspect inox brossé
Roestvrij staal finish geborsteld

| ••• | • | □ |
|-----------|-----|--------------|
| 160 | 172 | 9 112 672 40 |
| 224 / 260 | 272 | 9 112 674 40 |
| 320 / 360 | 372 | 9 064 819 25 |
| 416 / 460 | 472 | 9 064 820 25 |

| | ••• | • | □ |
|---|-----------|-----|--------------|
| 1 | 192 | 245 | 9 106 166 30 |
| 1 | 256 | 309 | 9 106 167 50 |
| 1 | 256 | 373 | 9 106 168 25 |
| 1 | 192 / 352 | 437 | 9 106 169 25 |
| 2 | 192 | 245 | 9 105 837 30 |
| 2 | 256 | 309 | 9 105 838 50 |
| 2 | 256 | 373 | 9 105 839 25 |
| 2 | 192 / 352 | 437 | 9 105 840 25 |

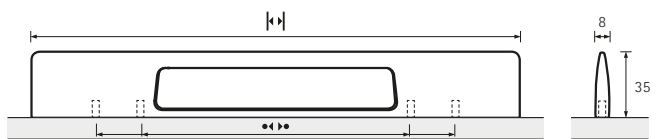
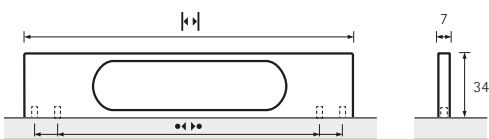

NEW MODERN

Torino



- 1 Verchromt glanz
Bright chrome plated
Chromé brillant
Verchromd glans



- 2 Edalstahl Optik gebürstet
Brushed stainless steel look
Aspect inox brossé
Roestvrij staal finish geborsteld

Velitra



- 1 Verchromt glanz
Bright chrome plated
Chromé brillant
Verchromd glans



- 2 Edalstahl Optik gebürstet
Brushed stainless steel look
Aspect inox brossé
Roestvrij staal finish geborsteld

| | ••• | • | □ |
|---|-----------|-----|--------------|
| 1 | 160 / 192 | 232 | 9 071 927 50 |
| 1 | 224 / 256 | 296 | 9 071 930 50 |
| 2 | 160 / 192 | 232 | 9 071 926 50 |
| 2 | 224 / 256 | 296 | 9 071 929 50 |

| | ••• | • | □ |
|---|-----------|-----|--------------|
| 1 | 128 / 192 | 204 | 9 208 551 50 |
| 1 | 224 / 260 | 272 | 9 208 578 50 |
| 1 | 260 / 320 | 372 | 9 208 579 25 |
| 1 | 360 / 416 | 472 | 9 208 580 25 |
| 2 | 128 / 192 | 204 | 0 115 018 50 |
| 2 | 224 / 260 | 272 | 0 115 014 50 |
| 2 | 260 / 320 | 372 | 0 115 016 25 |
| 2 | 360 / 416 | 472 | 0 115 017 25 |

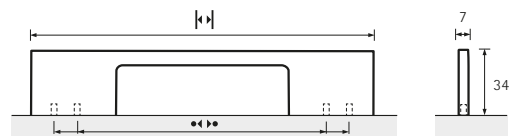
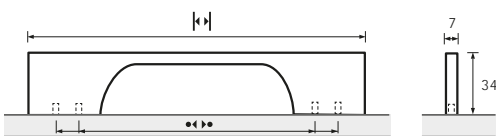

Capua



Edelstahl Optik gebürstet
Brushed stainless steel look
Aspect inox brossé
Roestvrij staal finish geborsteld

| ••• | • | | □ |
|-----------|-----|-----------|----|
| 160 | 172 | 9 112 666 | 40 |
| 224 / 260 | 272 | 9 112 667 | 40 |
| 320 / 360 | 372 | 9 064 670 | 25 |
| 416 / 460 | 472 | 9 064 671 | 25 |

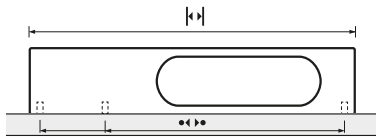

Imperia



Edelstahl Optik gebürstet
Brushed stainless steel look
Aspect inox brossé
Roestvrij staal finish geborsteld

| ••• | • | | □ |
|-----|-----|-----------|----|
| 192 | 220 | 9 995 585 | 40 |
| 224 | 252 | 9 995 586 | 40 |
| 320 | 348 | 9 995 587 | 40 |
| 448 | 476 | 9 995 588 | 40 |
| 541 | 569 | 9 995 589 | 40 |
| 560 | 588 | 9 995 590 | 40 |

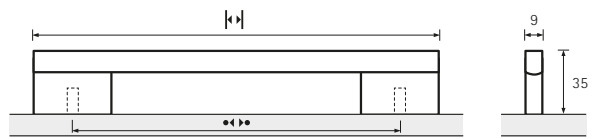

Evisa



1 Verchromt glanz
Bright chrome plated
Chromé brillant
Verchroomd glans



2 Edelstahl Optik gebürstet
Brushed stainless steel look
Aspect inox brossé
Roestvrij staal finish geborsteld

| | | □ |
|---|-----------|----|
| 1 | 9 113 501 | 30 |
| 2 | 9 113 502 | 30 |

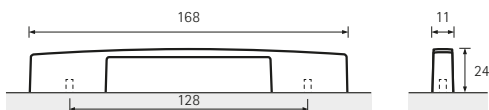

NEW MODERN

Zenga



1 Verchromt glanz
Bright chrome plated
Chromé brillant
Verchromd glans



3 Verchromt glanz
Bright chrome plated
Chromé brillant
Verchromd glans



2 Edeldahl Optik gebürstet
Brushed stainless steel look
Aspect inox brossé
Roestvrij staal finish geborsteld



4 Edeldahl Optik gebürstet
Brushed stainless steel look
Aspect inox brossé
Roestvrij staal finish geborsteld

| | | |
|---|-----------|----|
| | | ☐ |
| 1 | 9 105 742 | 25 |
| 2 | 9 105 743 | 25 |

| | | |
|---|-----------|----|
| | | ☐ |
| 3 | 9 105 746 | 25 |
| 4 | 9 105 747 | 25 |

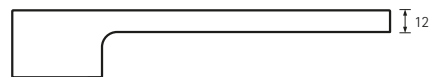
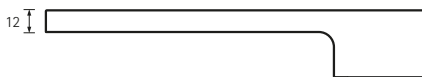
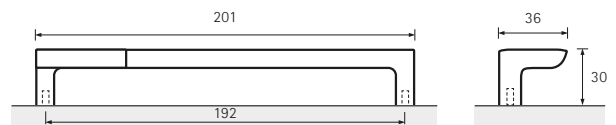
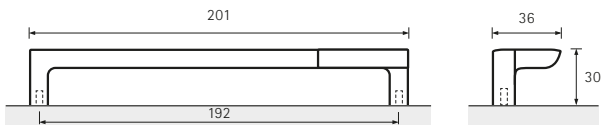

Bermeo



- 1 Edelstahl Optik gebürstet
Brushed stainless steel look
Aspect inox brossé
Roestvrij staal finish geborsteld



- 2 Schwarz matt /
Edelstahl Optik gebürstet
Matt black /
Brushed stainless steel look
Noir mat /
Aspect inox brossé
Zwart mat /
Roestvrij staal finish geborsteld

Nursia



- 1 Verchromt matt
Matt chrome plated
Chromé mat
Verchromd mat



- 2 Edelstahl Optik gebürstet
Brushed stainless steel look
Aspect inox brossé
Roestvrij staal finish geborsteld



- 3 Schwarz matt
Matt black
Noir mat
Zwart mat

| | ••• | | □ |
|---|-----|-----|--------------|
| 1 | 96 | 109 | 9 208 073 30 |
| 1 | 128 | 141 | 9 208 074 25 |
| 1 | 160 | 173 | 9 208 075 25 |
| 1 | 192 | 205 | 9 208 076 25 |
| 1 | 224 | 237 | 9 208 077 25 |
| 1 | 256 | 269 | 9 208 078 50 |
| 1 | 288 | 301 | 9 208 079 50 |
| 1 | 320 | 333 | 9 208 080 50 |
| | | | |
| 2 | 96 | 109 | 9 208 081 30 |
| 2 | 128 | 141 | 9 208 082 25 |
| 2 | 160 | 173 | 9 208 083 25 |
| 2 | 192 | 205 | 9 208 084 25 |
| 2 | 224 | 237 | 9 208 085 25 |
| 2 | 256 | 269 | 9 208 086 50 |
| 2 | 288 | 301 | 9 208 087 50 |
| 2 | 320 | 333 | 9 208 088 50 |

| | □ |
|---|--------------|
| 1 | 9 120 199 25 |
| 2 | 9 112 637 25 |
| 3 | 9 264 087 25 |

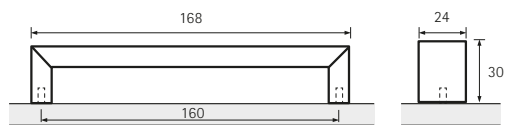
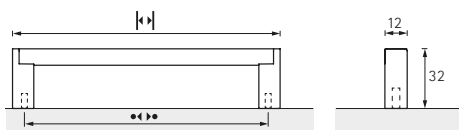

NEW MODERN

Cheam



- 1 Edelstahl Optik gebürstet
Brushed stainless steel look
Aspect inox brossé
Roestvrij staal finish geborsteld



- 2 Schwarz matt
Matt black
Noir mat
Zwart mat

Tornea



- 1 Verchromt glanz
Bright chrome plated
Chromé brillant
Verchromd glans



- 2 Edelstahl Optik gebürstet
Brushed stainless steel look
Aspect inox brossé
Roestvrij staal finish geborsteld



- 3 Schwarz matt
Matt black
Noir mat
Zwart mat

| | ••• | • | | □ |
|---|-----|-----|-----------|----|
| 1 | 128 | 163 | 9 268 262 | 20 |
| 1 | 160 | 195 | 9 268 219 | 25 |
| 1 | 192 | 227 | 9 113 212 | 20 |
| 2 | 128 | 163 | 9 252 428 | 20 |
| 2 | 160 | 195 | 9 252 429 | 25 |
| 2 | 192 | 227 | 9 252 430 | 20 |

| | ••• | • | | □ |
|---|-----|-----|-----------|----|
| 1 | 128 | 138 | 9 112 938 | 50 |
| 1 | 192 | 202 | 9 112 941 | 50 |
| 2 | 128 | 138 | 9 112 940 | 50 |
| 2 | 192 | 202 | 9 112 943 | 50 |
| 3 | 128 | 138 | 9 269 731 | 50 |
| 3 | 192 | 202 | 9 269 732 | 50 |

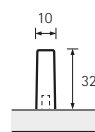
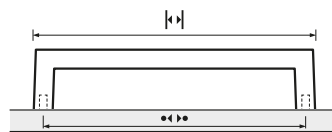
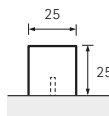

Anzio



Edelstahl gebürstet
Brushed stainless steel
Inox brossé
Roestvrij staal geborsteld

Arnum



Edelstahl gebürstet
Brushed stainless steel
Inox brossé
Roestvrij staal geborsteld

| ••• | k ₁ | k ₂ | □ |
|-----|-----------------|-----------------|--------------|
| 96 | 106 | 10 | 9 204 164 35 |
| 128 | 138 | 10 | 1 160 018 30 |
| 160 | 170 | 10 | 1 160 019 30 |
| 192 | 202 | 10 | 9 204 175 40 |
| 224 | 234 | 10 | 1 160 020 50 |
| 288 | 298 | 10 | 1 160 021 50 |
| 320 | 330 | 10 | 9 204 177 50 |
| 352 | 362 | 10 | 1 160 022 50 |
| 480 | 490 | 10 | 1 160 023 50 |
| 608 | 618 | 10 | 1 160 024 50 |
| 736 | 746 | 10 | 1 160 025 50 |

| ••• | k ₁ | k ₂ | □ |
|-----|-----------------|-----------------|--------------|
| 160 | 172 | 12 | 9 207 348 40 |
| 192 | 204 | 12 | 9 207 356 40 |
| 320 | 332 | 12 | 9 207 349 50 |
| 416 | 428 | 12 | 9 207 350 40 |
| 512 | 524 | 12 | 9 207 351 40 |
| 736 | 748 | 12 | 9 207 352 40 |
| 832 | 844 | 12 | 9 207 354 40 |

| k | □ |
|----|---------------|
| 10 | 9 208 071 150 |
| 12 | 9 208 072 150 |

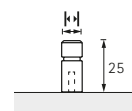
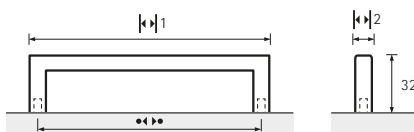

NEW MODERN

Aratti



Edelstahl gebürstet
Brushed stainless steel
Inox brossé
Roestvrij staal geborsteld

Aosta



Edelstahl gebürstet
Brushed stainless steel
Inox brossé
Roestvrij staal geborsteld

9 208 070 150

| ••• | • | | □ |
|-----|------|-----------|----|
| 96 | 112 | 9 113 247 | 30 |
| 128 | 144 | 9 069 804 | 50 |
| 160 | 176 | 9 069 805 | 25 |
| 192 | 208 | 9 069 806 | 25 |
| 224 | 240 | 9 069 807 | 25 |
| 256 | 272 | 9 113 248 | 40 |
| 320 | 336 | 9 069 808 | 25 |
| 352 | 368 | 9 113 250 | 25 |
| 384 | 400 | 9 113 251 | 25 |
| 416 | 432 | 9 113 252 | 25 |
| 480 | 496 | 9 207 357 | 25 |
| 584 | 600 | 9 113 255 | 25 |
| 684 | 700 | 9 113 257 | 25 |
| 784 | 800 | 9 113 258 | 25 |
| 984 | 1000 | 9 207 358 | 25 |

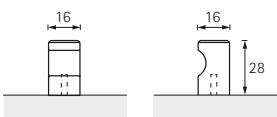

Clivia



1 Aluminium eloxiert
Aluminium, anodised
Aluminium anodisé
Aluminium geëloxeerd



2 Schwarz matt
Matt black
Noir mat
Zwart mat

| | «»» | « | | □ |
|---|-----|-----|-----------|----|
| 1 | 96 | 108 | 0 115 205 | 50 |
| 1 | 128 | 140 | 0 115 355 | 50 |
| 1 | 160 | 172 | 0 115 353 | 50 |
| 1 | 192 | 204 | 0 115 354 | 50 |
| 1 | 208 | 220 | 0 115 215 | 25 |
| 1 | 224 | 236 | 0 115 206 | 25 |
| 1 | 232 | 244 | 0 115 356 | 50 |
| 1 | 256 | 268 | 0 115 207 | 25 |
| 1 | 282 | 294 | 0 115 357 | 25 |
| 1 | 288 | 300 | 0 115 208 | 25 |
| 1 | 332 | 344 | 0 115 358 | 25 |
| 1 | 352 | 364 | 0 115 209 | 20 |
| 1 | 382 | 394 | 0 115 359 | 25 |

| | «»» | « | | □ |
|---|-----------|------|-----------|----|
| 1 | 416 | 428 | 0 115 210 | 20 |
| 1 | 432 | 444 | 0 115 360 | 25 |
| 1 | 448 | 460 | 0 115 211 | 25 |
| 1 | 482 | 494 | 0 115 361 | 25 |
| 1 | 512 | 524 | 0 115 213 | 25 |
| 1 | 532 | 544 | 0 115 362 | 25 |
| 1 | 544 | 556 | 0 115 214 | 25 |
| 1 | 632 | 644 | 0 115 364 | 25 |
| 1 | 732 | 744 | 0 115 363 | 25 |
| 1 | 2 x 416 | 844 | 0 115 212 | 25 |
| 1 | 2 x 477,5 | 967 | 0 115 216 | 25 |
| 1 | 2 x 564 | 1140 | 0 115 217 | 20 |
| 1 | 2 x 644 | 1300 | 0 115 218 | 20 |

| | «»» | « | | □ |
|---|-----|-----|-----------|----|
| 2 | 96 | 108 | 9 265 888 | 50 |
| 2 | 128 | 140 | 9 265 879 | 50 |
| 2 | 160 | 172 | 9 265 880 | 50 |
| 2 | 192 | 204 | 9 265 921 | 50 |
| 2 | 208 | 220 | 9 265 922 | 25 |
| 2 | 224 | 236 | 9 265 923 | 25 |
| 2 | 232 | 244 | 9 265 924 | 50 |
| 2 | 256 | 268 | 9 265 925 | 25 |
| 2 | 282 | 294 | 9 265 926 | 25 |
| 2 | 288 | 300 | 9 265 927 | 25 |
| 2 | 332 | 344 | 9 265 928 | 25 |
| 2 | 352 | 364 | 9 265 929 | 20 |
| 2 | 382 | 394 | 9 265 930 | 25 |

| | «»» | « | | □ |
|---|-----------|------|-----------|----|
| 2 | 416 | 428 | 9 265 931 | 20 |
| 2 | 432 | 444 | 9 265 932 | 25 |
| 2 | 448 | 460 | 9 265 933 | 25 |
| 2 | 482 | 494 | 9 265 934 | 25 |
| 2 | 512 | 524 | 9 265 935 | 25 |
| 2 | 532 | 544 | 9 265 936 | 25 |
| 2 | 544 | 556 | 9 265 937 | 25 |
| 2 | 632 | 644 | 9 265 938 | 25 |
| 2 | 732 | 744 | 9 265 939 | 25 |
| 2 | 2 x 416 | 844 | 9 265 940 | 25 |
| 2 | 2 x 477,5 | 967 | 9 265 941 | 25 |
| 2 | 2 x 564 | 1140 | 9 265 942 | 20 |
| 2 | 2 x 644 | 1300 | 9 265 943 | 20 |

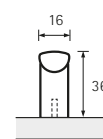
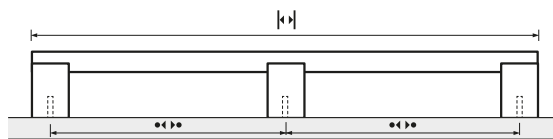

NEW MODERN

Alvito



Verchromt glanz
Bright chrome plated
Chromé brillant
Verchromd glans



| ••• | • | □ |
|-----------|-----|---|
| 9 113 635 | 150 | |

Pola



Edelstahl gebürstet
Brushed stainless steel
Inox brossé
Roestvrij staal geborsteld

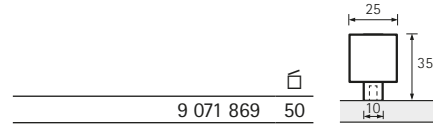

| ••• | • | □ |
|-----------|----|---|
| 9 071 869 | 50 | |

Guarani



Edelstahl gebürstet
Brushed stainless steel
Inox brossé
Roestvrij staal geborsteld

| ••• | • | □ |
|-----|-----|--------------|
| 128 | 149 | 9 208 046 40 |
| 160 | 181 | 9 208 047 50 |
| 192 | 223 | 9 208 048 50 |
| 224 | 259 | 9 208 049 50 |

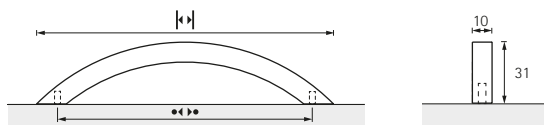

Narona



Edelstahl gebürstet
Brushed stainless steel
Inox brossé
Roestvrij staal geborsteld

| ••• | • | □ |
|-----|-----|--------------|
| 96 | 108 | 9 070 970 50 |
| 128 | 140 | 9 070 973 25 |
| 160 | 172 | 9 070 975 40 |
| 192 | 204 | 9 070 992 40 |
| 224 | 236 | 9 203 963 40 |
| 288 | 300 | 9 070 995 50 |
| 320 | 332 | 9 070 998 50 |
| 352 | 364 | 9 070 977 25 |
| 384 | 396 | 9 070 979 25 |

| ••• | • | □ |
|-----|-----|--------------|
| 480 | 492 | 9 071 000 25 |
| 640 | 652 | 9 071 010 15 |
| 736 | 748 | 9 071 013 15 |

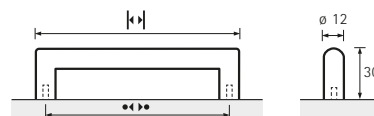

Hale



- 1 Verchromt glanz
Bright chrome plated
Chromé brillant
Verchromd glans

| | ••• | • | | □ |
|---|-----|-----|-----------|----|
| 1 | 96 | 156 | 9 070 807 | 20 |
| 1 | 128 | 188 | 9 070 809 | 40 |
| 1 | 160 | 220 | 9 070 811 | 40 |
| 1 | 192 | 252 | 9 070 817 | 40 |
| 1 | 224 | 284 | 9 070 821 | 50 |
| 1 | 288 | 348 | 9 070 813 | 25 |
| 1 | 352 | 412 | 9 070 825 | 25 |
| 1 | 448 | 508 | 9 070 803 | 25 |
| 1 | 480 | 540 | 9 070 816 | 25 |



- 2 Edelhstahl Optik gebürstet
Brushed stainless steel look
Aspect inox brossé
Roestvrij staal finish geborsteld

| | ••• | • | | □ |
|---|-----------|------|-----------|----|
| 2 | 96 | 156 | 9 070 674 | 20 |
| 2 | 128 | 188 | 9 070 750 | 40 |
| 2 | 160 | 220 | 9 070 796 | 40 |
| 2 | 184 | 244 | 9 070 746 | 40 |
| 2 | 192 | 252 | 9 070 765 | 40 |
| 2 | 224 | 284 | 9 070 763 | 50 |
| 2 | 234 | 294 | 9 070 742 | 50 |
| 2 | 284 | 344 | 9 070 734 | 50 |
| 2 | 288 | 348 | 9 070 759 | 25 |
| 2 | 334 | 394 | 9 070 733 | 25 |
| 2 | 352 | 412 | 9 070 758 | 25 |
| 2 | 384 | 444 | 9 070 732 | 25 |
| 2 | 434 | 494 | 9 070 736 | 25 |
| 2 | 448 | 508 | 9 070 756 | 25 |
| 2 | 480 | 540 | 9 070 753 | 25 |
| 2 | 484 | 544 | 9 070 738 | 25 |
| 2 | 784 | 844 | 9 070 743 | 20 |
| 2 | 2 x 453,5 | 967 | 9 070 747 | 15 |
| 2 | 2 x 540 | 1140 | 9 070 751 | 15 |
| 2 | 2 x 620 | 1300 | 9 070 755 | 15 |

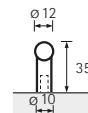
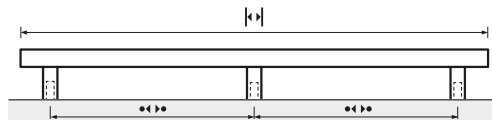
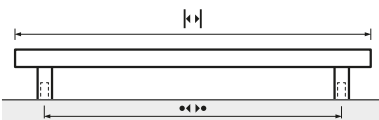

NEW MODERN

Salvia



Edelstahl gebürstet
Brushed stainless steel
Inox brossé
Roestvrij staal geborsteld

ø10



| Ø | ••• | • | | □ |
|----|-----|-----|-----------|----|
| 10 | 96 | 156 | 9 070 967 | 50 |
| 10 | 128 | 188 | 9 070 972 | 50 |
| 10 | 160 | 220 | 9 070 978 | 50 |
| 10 | 192 | 252 | 9 070 982 | 50 |
| 10 | 224 | 284 | 9 070 984 | 75 |
| 10 | 256 | 316 | 9 070 988 | 75 |
| 10 | 288 | 348 | 9 070 991 | 25 |
| 10 | 320 | 380 | 9 070 993 | 20 |
| 10 | 352 | 412 | 9 070 996 | 20 |
| 10 | 384 | 444 | 9 070 999 | 20 |

ø14



| Ø | ••• | • | | □ |
|----|---------|------|-----------|----|
| 14 | 96 | 158 | 9 071 045 | 50 |
| 14 | 128 | 188 | 9 071 046 | 25 |
| 14 | 160 | 220 | 9 071 048 | 25 |
| 14 | 192 | 252 | 9 071 050 | 25 |
| 14 | 224 | 284 | 9 071 051 | 25 |
| 14 | 256 | 316 | 9 071 052 | 25 |
| 14 | 288 | 348 | 9 071 053 | 25 |
| 14 | 320 | 380 | 9 071 054 | 20 |
| 14 | 352 | 412 | 9 071 055 | 20 |
| 14 | 384 | 444 | 9 071 056 | 20 |
| 14 | 448 | 508 | 9 071 058 | 20 |
| 14 | 480 | 540 | 9 071 111 | 20 |
| 14 | 640 | 700 | 9 071 112 | 15 |
| 14 | 736 | 796 | 9 071 115 | 15 |
| 14 | 2 x 480 | 1020 | 9 071 116 | 15 |
| 14 | 2 x 640 | 1340 | 9 071 118 | 1 |
| 14 | 2 x 720 | 1500 | 9 071 120 | 1 |

ø12



| Ø | ••• | • | | □ |
|----|---------|------|-----------|----|
| 12 | 96 | 157 | 9 071 003 | 50 |
| 12 | 128 | 188 | 9 071 005 | 50 |
| 12 | 160 | 220 | 9 071 008 | 50 |
| 12 | 192 | 252 | 9 071 009 | 50 |
| 12 | 224 | 284 | 9 071 012 | 50 |
| 12 | 256 | 316 | 9 071 017 | 50 |
| 12 | 288 | 348 | 9 071 020 | 25 |
| 12 | 320 | 380 | 9 071 021 | 20 |
| 12 | 352 | 412 | 9 071 023 | 20 |
| 12 | 384 | 444 | 9 071 024 | 20 |
| 12 | 448 | 508 | 9 071 026 | 20 |
| 12 | 480 | 540 | 9 071 027 | 20 |
| 12 | 640 | 700 | 9 071 030 | 15 |
| 12 | 736 | 796 | 9 071 038 | 15 |
| 12 | 2 x 480 | 1020 | 9 071 041 | 15 |
| 12 | 2 x 640 | 1340 | 9 071 042 | 1 |
| 12 | 2 x 720 | 1500 | 9 071 043 | 1 |

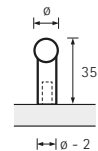
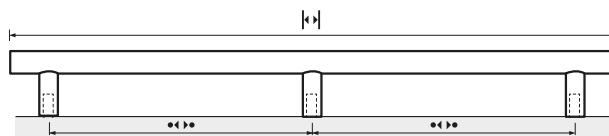

↳|ø - 2

Kervo



- 1 Aluminium eloxiert
Aluminium, anodised
Aluminium anodisé
Aluminium geëloxeerd



- 2 Schwarz matt
Matt black
Noir mat
Zwart mat

Fermo



- 1 Verchromt glanz
Bright chrome plated
Chromé brillant
Verchromd glans



- 2 Edeldstahl Optik gebürstet
Brushed stainless steel look
Aspect inox brossé
Roestvrij staal finish geborsteld

| | ••• | • | | □ |
|---|-----------|------|-----------|-----|
| 1 | 32 | 56 | 9 190 436 | 100 |
| 1 | 64 | 88 | 9 194 367 | 100 |
| 1 | 96 / 128 | 152 | 9 190 437 | 100 |
| 1 | 160 / 192 | 216 | 9 190 438 | 50 |
| 1 | 224 / 256 | 280 | 9 190 439 | 100 |
| 1 | 5 x 224 | 1100 | 9 190 440 | 25 |
| 2 | 32 | 56 | 9 190 441 | 100 |
| 2 | 64 | 88 | 9 194 368 | 100 |
| 2 | 96 / 128 | 152 | 9 190 442 | 100 |
| 2 | 160 / 192 | 216 | 9 190 443 | 50 |
| 2 | 224 / 256 | 280 | 9 190 444 | 100 |

| | | □ |
|---|-----------|----|
| 1 | 0 115 020 | 50 |
| 2 | 0 115 019 | 50 |

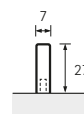
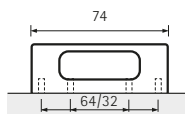
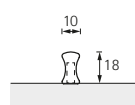
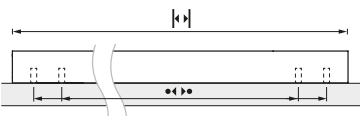

NEW MODERN

Stabia



1 Verchromt glanz
Bright chrome plated
Chromé brillant
Verchromd glans



3 Edalstahl Optik gebürstet
Brushed stainless steel look
Aspect inox brossé
Roestvrij staal finish geborsteld



2 Aluminium eloxiert
Aluminium, anodised
Aluminium anodisé
Aluminium geëloxeerd

| | «»» | « | □ | | «»» | « | □ | | |
|---|----------|------|-----------|-----|-----|-----|-----|-----------|-----|
| 1 | 64 | 76 | 9 209 059 | 100 | 3 | 64 | 76 | 9 204 159 | 100 |
| 1 | 96 | 108 | 9 209 060 | 100 | 3 | 96 | 108 | 9 204 161 | 100 |
| 1 | 128 | 140 | 9 209 061 | 50 | 3 | 128 | 140 | 9 204 162 | 50 |
| 1 | 160 | 172 | 9 209 062 | 75 | 3 | 160 | 172 | 9 204 163 | 75 |
| 1 | 192 | 204 | 9 209 063 | 75 | 3 | 192 | 204 | 9 204 160 | 75 |
| 1 | 224 | 236 | 9 209 064 | 50 | 3 | 224 | 236 | 9 209 058 | 50 |
| 2 | 64 | 76 | 9 204 157 | 100 | | | | | |
| 2 | 96 | 108 | 0 115 023 | 100 | | | | | |
| 2 | 128 | 140 | 0 115 021 | 50 | | | | | |
| 2 | 160 | 172 | 0 115 022 | 75 | | | | | |
| 2 | 192 | 204 | 9 204 158 | 75 | | | | | |
| 2 | 224 | 236 | 0 115 024 | 50 | | | | | |
| 2 | 13 x 224 | 2924 | 9 120 134 | 8 | | | | | |

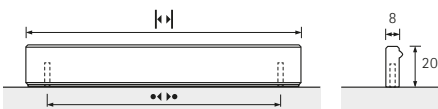

Rovigo



1 Verchromt glanz
Bright chrome plated
Chromé brillant
Verchroomd glans



3 Edalstahl Optik gebürstet
Brushed stainless steel look
Aspect inox brossé
Roestvrij staal finish geborsteld



2 Aluminium eloxiert
Aluminium, anodised
Aluminium anodisé
Aluminium geëloxeerd

| | «» | « | | □ |
|---|---------|------|-----------|----|
| 1 | 64 | 79 | 9 204 195 | 40 |
| 1 | 96 | 111 | 9 204 022 | 35 |
| 1 | 128 | 143 | 9 204 023 | 25 |
| 1 | 160 | 175 | 9 113 297 | 25 |
| 1 | 192 | 207 | 9 204 024 | 25 |
| 1 | 224 | 239 | 9 113 299 | 25 |
| 2 | 64 | 79 | 9 204 197 | 40 |
| 2 | 96 | 111 | 9 204 028 | 35 |
| 2 | 128 | 143 | 9 204 029 | 25 |
| 2 | 160 | 175 | 9 204 030 | 25 |
| 2 | 192 | 207 | 9 204 031 | 25 |
| 2 | 224 | 239 | 9 204 032 | 25 |
| 2 | 8 x 224 | 2000 | 9 204 033 | 8 |

| | «» | « | | □ |
|---|-----|-----|-----------|----|
| 3 | 64 | 79 | 9 204 196 | 40 |
| 3 | 96 | 111 | 9 204 025 | 35 |
| 3 | 128 | 143 | 9 204 026 | 25 |
| 3 | 160 | 175 | 9 113 298 | 25 |
| 3 | 192 | 207 | 9 204 027 | 25 |
| 3 | 224 | 239 | 9 113 300 | 25 |

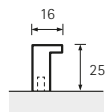

NEW MODERN

Canis L



1 Aluminium eloxiert
Aluminium, anodised
Aluminium anodisé
Aluminium geëloxeerd



2 Edelstahl Optik
Stainless steel look
Aspect inox
Roestvrij staal finish



3 Schwarz matt
Matt black
Noir mat
Zwart mat



4 Innenecke 90° / Aluminium Optik
90° inside corner / Aluminium look
Angle intérieur 90° / Aspect aluminium
Binnenhoek 90° / Aluminiumkleurig



5 Innenecke 90° / Edelstahl Optik
90° inside corner / Stainless steel look
Angle intérieur 90° / Aspect inox
Binnenhoek 90° / Roestvrij staal finish



6 Innenecke 90° / Schwarz matt
90° inside corner / Matt black
Angle intérieur 90° / Noir mat
Binnenhoek 90° / Zwart mat

| | | □ | ⊙ |
|---|-----------|---|---|
| 1 | 9 210 115 | 8 | ⊙ |
| 2 | 9 210 116 | 8 | ⊙ |
| 3 | 9 266 104 | 8 | ⊙ |

| | | □ |
|---|-----------|----|
| 4 | 9 210 117 | 50 |
| 5 | 9 210 119 | 50 |
| 6 | 9 266 105 | 50 |



7 Außenecke 90° / Aluminium Optik
90° outside corner / Aluminium look
Angle extérieur 90° / Aspect aluminium
Buitenhoek 90° / Aluminiumkleurig



8 Außenecke 90° / Edelstahl Optik
90° outside corner / Stainless steel look
Angle extérieur 90° / Aspect inox
Buitenhoek 90° / Roestvrij staal finish



9 Außenecke 90° / Schwarz matt
90° outside corner / Matt black
Angle extérieur 90° / Noir mat
Buitenhoek 90° / Zwart mat

| 7 | 9 210 122 | 50 | |
|---|-----------|----|--|
| 8 | 9 210 125 | 50 | |
| 9 | 9 266 106 | 50 | |



10 Endkappen geschlossen, Set / Aluminium Optik
Set of closed end caps / Aluminium look
Kit d'embouts fermés / Aspect aluminium
Set gesloten eindkappen / Aluminiumkleurig



11 Endkappen geschlossen, Set / Edelstahl Optik
Set of closed end caps / Stainless steel look
Kit d'embouts fermés / Aspect inox
Set gesloten eindkappen / Roestvrij staal finish



12 Endkappen geschlossen, Set / Schwarz matt
Set of closed end caps / Matt black
Kit d'embouts fermés / Noir mat
Set gesloten eindkappen / Zwart mat

| 10 | 9 210 126 | 50 | |
|----|-----------|----|--|
| 11 | 9 210 128 | 50 | |
| 12 | 9 266 107 | 50 | |



13 Befestigungswinkel / Stahl verzinkt
Fixing bracket / Galvanised steel
Cornières de fixation / Acier zingué
Bevestigingshoek / Verzinkt staal



14 Befestigungswinkel gekröpft, beim Einsatz von Endkappen / Stahl verzinkt
Fixing bracket cranked, required when using end caps / Galvanised steel
Cornières de fixation coudée, nécessaire en cas d'utilisation de embouts / Acier zingué
Bevestigingshoek bocht, bij gebruik van eindkappen / Verzinkt staal



15 Befestigungswinkel / Stahl verzinkt
Fixing bracket / Galvanised steel
Cornières de fixation / Acier zingué
Bevestigingshoek / Verzinkt staal

| 13 | 9 210 142 | 100 | |
|----|-----------|-----|--|
| 14 | 9 210 143 | 100 | |
| 15 | 9 210 129 | 100 | |

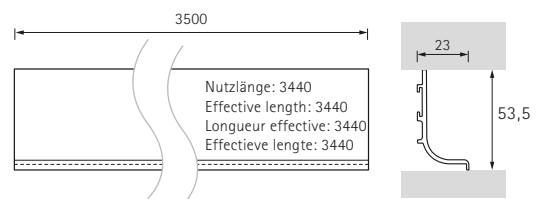

NEW MODERN

Canis C



1 Aluminium eloxiert
Aluminium, anodised
Aluminium anodisé
Aluminium geëloxeerd



2 Edelstahl Optik
Stainless steel look
Aspect inox
Roestvrij staal finish



3 Schwarz matt
Matt black
Noir mat
Zwart mat



4 Innenecke 90° / Aluminium Optik
90° inside corner / Aluminium look
Angle intérieur 90° / Aspect aluminium
Binnenhoek 90° / Aluminiumkleurig



5 Innenecke 90° / Edelstahl Optik
90° inside corner / Stainless steel look
Angle intérieur 90° / Aspect inox
Binnenhoek 90° / Roestvrij staal finish



6 Innenecke 90° / Schwarz matt
90° inside corner / Matt black
Angle intérieur 90° / Noir mat
Binnenhoek 90° / Zwart mat

| | | □ | ⊙ |
|---|-----------|---|---|
| 1 | 9 210 130 | 8 | ⊙ |
| 2 | 9 210 132 | 8 | ⊙ |
| 3 | 9 266 132 | 8 | ⊙ |

| | | □ |
|---|-----------|----|
| 4 | 9 210 133 | 50 |
| 5 | 9 210 136 | 50 |
| 6 | 9 266 133 | 50 |



7 Außenecke 90° / Aluminium Optik
90° outside corner / Aluminium look
Angle extérieur 90° / Aspect aluminium
Buitenhoek 90° / Aluminiumkleurig



8 Außenecke 90° / Edelstahl Optik
90° outside corner / Stainless steel look
Angle extérieur 90° / Aspect inox
Buitenhoek 90° / Roestvrij staal finish



9 Außenecke 90° / Schwarz matt
90° outside corner / Matt black
Angle extérieur 90° / Noir mat
Buitenhoek 90° / Zwart mat

| 7 | 9 210 138 | 50 | |
|---|-----------|----|--|
| 8 | 9 210 139 | 50 | |
| 9 | 9 266 134 | 50 | |



13 Befestigungswinkel / Stahl verzinkt
Fixing bracket / Galvanised steel
Cornières de fixation / Acier zingué
Bevestigingshoek / Verzinkt staal



14 Befestigungswinkel gekröpft, beim Einsatz von Endkappen / Stahl verzinkt
Fixing bracket cranked, required when using end caps / Galvanised steel
Cornières de fixation coudée, nécessaire en cas d'utilisation de embouts / Acier zingué
Bevestigingshoek bocht, bij gebruik van eindkappen / Verzinkt staal



15 Befestigungswinkel / Stahl verzinkt
Fixing bracket / Galvanised steel
Cornières de fixation / Acier zingué
Bevestigingshoek / Verzinkt staal

| 13 | 9 210 142 | 100 | |
|----|-----------|-----|--|
| 14 | 9 210 143 | 100 | |
| 15 | 9 210 129 | 100 | |



10 Endkappen geschlossen, Set / Aluminium Optik
Set of closed end caps / Aluminium look
Kit d'embouts fermés / Aspect aluminium
Set gesloten eindkappen / Aluminiumkleurig



11 Endkappen geschlossen, Set / Edelstahl Optik
Set of closed end caps / Stainless steel look
Kit d'embouts fermés / Aspect inox
Set gesloten eindkappen / Roestvrij staal finish



12 Endkappen geschlossen, Set / Schwarz matt
Set of closed end caps / Matt black
Kit d'embouts fermés / Noir mat
Set gesloten eindkappen / Zwart mat

| 10 | 9 210 140 | 50 | |
|----|-----------|----|--|
| 11 | 9 210 141 | 50 | |
| 12 | 9 266 135 | 50 | |

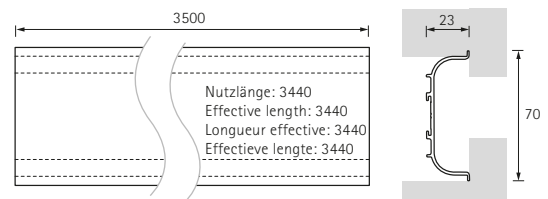

NEW MODERN

Celista



- 1 Weiß
White
Blanc
Wit



- 2 Edelstahl Optik gebürstet
Brushed stainless steel look
Aspect inox brossé
Roestvrij staal finish geborsteld



- 3 Schwarz matt
Matt black
Noir mat
Zwart mat

| | | ☐ |
|---|-----------|----|
| 1 | 9 082 137 | 25 |
| 2 | 9 080 838 | 25 |
| 3 | 9 082 136 | 25 |

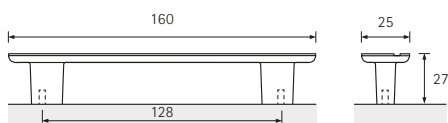

Genoa



- 1 Verchromt glanz
Bright chrome plated
Chromé brillant
Verchromd glans



- 2 Edelstahl Optik gebürstet
Brushed stainless steel look
Aspect inox brossé
Roestvrij staal finish geborsteld

| | | ☐ |
|---|-----------|----|
| 1 | 9 065 611 | 30 |
| 2 | 9 065 612 | 30 |

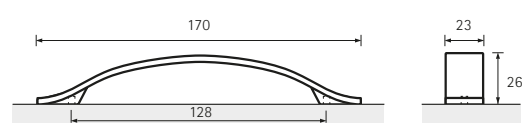

Rialto



1 Verchromt glanz
Bright chrome plated
Chromé brillant
Verchromd glans



2 Edeltahl Optik gebürstet
Brushed stainless steel look
Aspect inox brossé
Roestvrij staal finish geborsteld



3 Schwarz matt
Matt black
Noir mat
Zwart mat

Messana



1 Verchromt glanz
Bright chrome plated
Chromé brillant
Verchromd glans



2 Edeltahl Optik gebürstet
Brushed stainless steel look
Aspect inox brossé
Roestvrij staal finish geborsteld

| | | ☐ |
|---|-----------|----|
| 1 | 9 097 953 | 25 |
| 2 | 9 097 950 | 25 |
| 3 | 9 264 086 | 25 |

| | | ☐ |
|---|-----------|----|
| 1 | 0 115 157 | 50 |
| 2 | 0 115 156 | 50 |

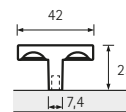
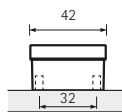
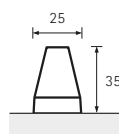
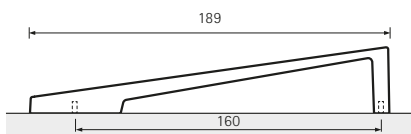

NEW MODERN

Milo



1 Verchromt glanz
Bright chrome plated
Chromé brillant
Verchroomd glans



2 Edelhstahl Optik gebürstet
Brushed stainless steel look
Aspect inox brossé
Roestvrij staal finish geborsteld

| | | | ☐ |
|---|-----------|-----|---|
| 1 | 9 105 793 | 100 | |
| 2 | 9 105 794 | 100 | |

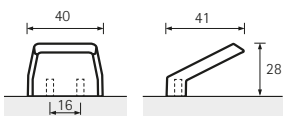

Venusia



1 Verchromt glanz
Bright chrome plated
Chromé brillant
Verchroomd glans



2 Edelhstahl Optik gebürstet
Brushed stainless steel look
Aspect inox brossé
Roestvrij staal finish geborsteld

| | | | ☐ |
|---|-----------|----|---|
| 1 | 0 115 155 | 25 | |
| 2 | 0 115 154 | 25 | |

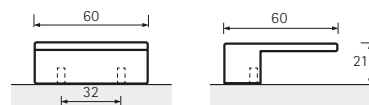

Trani



1 Aluminium eloxiert
Aluminium, anodised
Aluminium anodisé
Aluminium geëloxeerd



2 Schwarz matt
Matt black
Noir mat
Zwart mat

Ticinum



1 Aluminium eloxiert
Aluminium, anodised
Aluminium anodisé
Aluminium geëloxeerd

| | ••• | • | | □ |
|---|-----|-----|-----------|----|
| 1 | 32 | 52 | 9 995 437 | 60 |
| 1 | 64 | 84 | 9 995 438 | 50 |
| 1 | 96 | 116 | 9 995 439 | 50 |
| 1 | 128 | 148 | 9 995 440 | 25 |
| 2 | 32 | 52 | 9 265 949 | 60 |
| 2 | 64 | 84 | 9 265 950 | 50 |
| 2 | 96 | 116 | 9 265 971 | 50 |
| 2 | 128 | 148 | 9 265 972 | 25 |

| | ••• | • | | □ |
|--|---------|------|-----------|----|
| | 32 | 50 | 9 070 583 | 75 |
| | 50 | 70 | 9 070 588 | 75 |
| | 70 | 90 | 9 070 593 | 50 |
| | 8 x 224 | 2000 | 9 131 455 | 12 |

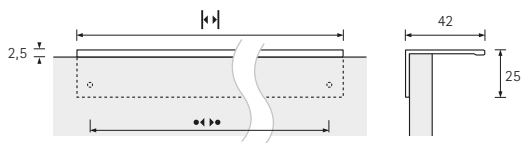
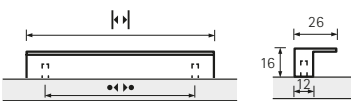

NEW MODERN

Narni



Edelstahl gebürstet
Brushed stainless steel
Inox brossé
Roestvrij staal geborsteld

Empoli



1 Verchromt glanz
Bright chrome plated
Chromé brillant
Verchromd glans



2 Verchromt matt
Matt chrome plated
Chromé mat
Verchromd mat



3 Edelstahl Optik gebürstet
Brushed stainless steel look
Aspect inox brossé
Roestvrij staal finish geborsteld

| ••• | •• | | □ |
|-----|----|-----------|----|
| 20 | 30 | 9 995 574 | 75 |
| 50 | 60 | 9 158 400 | 50 |
| 80 | 90 | 9 206 741 | 50 |

| | | □ |
|---|-----------|----|
| 1 | 9 995 541 | 70 |
| 2 | 9 995 540 | 70 |
| 3 | 9 995 542 | 70 |

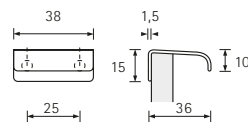
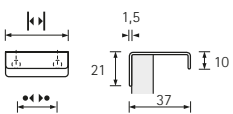

Lamezia



- 1 Verchromt glanz
Bright chrome plated
Chromé brillant
Verchromd glans



- 2 Aluminium eloxiert
Aluminium, anodised
Aluminium anodisé
Aluminium geëloxeerd



- 3 Edielstahl Optik gebürstet
Brushed stainless steel look
Aspect inox brossé
Roestvrij staal finish geborsteld



- 4 Schwarz matt
Matt black
Noir mat
Zwart mat



- 5 Gold Optik matt gebürstet
Gold look matt brushed
Aspect doré brossé mat
Goudkleurig mat geborsteld

| | | □ |
|-------|------|--------------|
| 1 | 295 | 9 105 801 50 |
| 1 | 345 | 9 105 802 25 |
| 1 | 395 | 9 105 803 25 |
| 1 | 445 | 9 105 805 25 |
| 1 | 495 | 9 105 806 25 |
| 1 | 595 | 9 105 807 25 |
| 1 | 795 | 9 105 809 25 |
| 1 | 895 | 9 105 810 25 |
| 1 | 995 | 9 105 811 25 |
| 1 | 1195 | 9 105 813 20 |
| <hr/> | | |
| 2 | 295 | 9 105 827 50 |
| 2 | 345 | 9 105 828 25 |
| 2 | 395 | 9 105 829 25 |
| 2 | 445 | 9 105 830 25 |
| 2 | 495 | 9 105 831 25 |
| 2 | 595 | 9 105 832 25 |
| 2 | 795 | 9 105 833 25 |
| 2 | 895 | 9 105 834 25 |
| 2 | 995 | 9 105 835 25 |
| 2 | 1195 | 9 105 836 20 |
| <hr/> | | |
| 3 | 295 | 9 105 815 50 |
| 3 | 345 | 9 105 816 25 |
| 3 | 395 | 9 105 819 25 |
| 3 | 445 | 9 105 820 25 |
| 3 | 495 | 9 105 821 25 |
| 3 | 595 | 9 105 822 25 |
| 3 | 795 | 9 105 823 25 |
| 3 | 895 | 9 105 824 25 |
| 3 | 995 | 9 105 825 25 |
| 3 | 1195 | 9 105 826 20 |
| <hr/> | | |
| 4 | 295 | 9 265 973 50 |
| 4 | 345 | 9 265 975 25 |
| 4 | 395 | 9 265 976 25 |
| 4 | 445 | 9 265 977 25 |
| 4 | 495 | 9 265 978 25 |
| 4 | 595 | 9 265 979 25 |
| 4 | 795 | 9 265 980 25 |
| 4 | 895 | 9 265 981 25 |
| 4 | 995 | 9 265 982 25 |
| 4 | 1195 | 9 265 983 20 |
| <hr/> | | |
| 5 | 295 | 9 265 985 50 |
| 5 | 345 | 9 265 986 25 |
| 5 | 395 | 9 265 987 25 |
| 5 | 445 | 9 265 988 25 |
| 5 | 495 | 9 265 989 25 |
| 5 | 595 | 9 265 990 25 |
| 5 | 795 | 9 265 991 25 |
| 5 | 895 | 9 265 992 25 |
| 5 | 995 | 9 265 993 25 |
| 5 | 1195 | 9 265 994 20 |

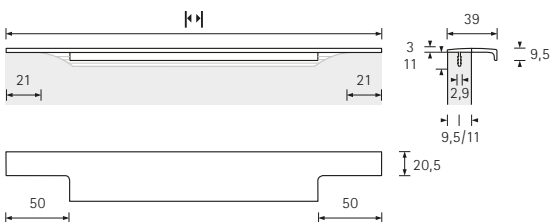

NEW MODERN

Lindavia



Aluminium eloxiert
Aluminium, anodised
Aluminium anodisé
Aluminium geëloxeerd

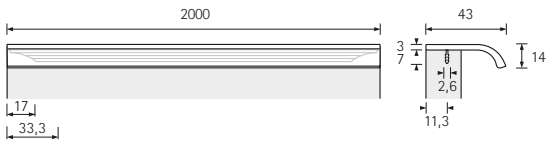
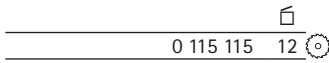

Lutetia



Aluminium eloxiert
Aluminium, anodised
Aluminium anodisé
Aluminium geëloxeerd

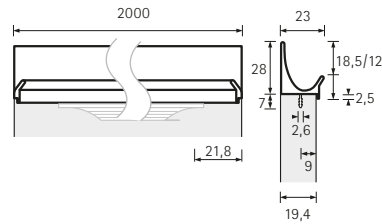
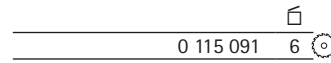

Eslinga



Aluminium eloxiert
Aluminium, anodised
Aluminium anodisé
Aluminium geëloxeerd

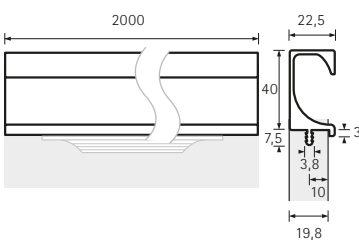
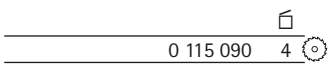

Seveso



Aluminium eloxiert
Aluminium, anodised
Aluminium anodisé
Aluminium geëloxeerd

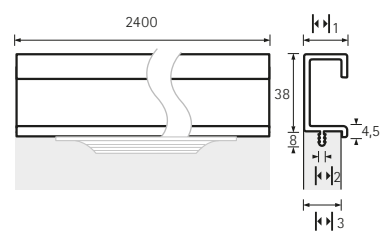

| k ₁ | k ₂ | k ₃ | | | | |
|----------------|----------------|----------------|-----------|---|---|---|
| 17 | 3 | 17 | 9 995 122 | 6 | 6 | 6 |
| 19 | 3 | 19 | 9 995 123 | 6 | 6 | 6 |



Mosena



Aluminium eloxiert
Aluminium, anodised
Aluminium anodisé
Aluminium geëloxeerd

9 237 970 10  

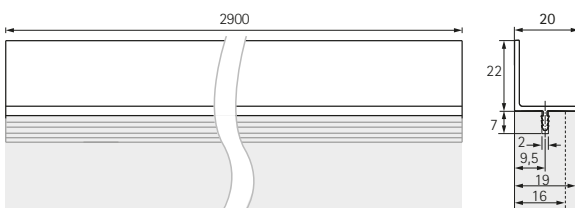

NEW MODERN

Riaza



- 1 Aluminium eloxiert
Aluminium, anodised
Aluminium anodisé
Aluminium geëloxeerd



- 2 Edelfstahl Optik gebürstet
Brushed stainless steel look
Aspect inox brossé
Roestvrij staal finish geborsteld



- 3 Schwarz matt
Matt black
Noir mat
Zwart mat

| | | | □ |
|---|------|-----------|----|
| 1 | 295 | 9 208 097 | 30 |
| 1 | 395 | 9 208 098 | 20 |
| 1 | 445 | 9 208 099 | 20 |
| 1 | 495 | 9 208 100 | 20 |
| 1 | 595 | 9 208 101 | 20 |
| 1 | 795 | 9 208 102 | 20 |
| 1 | 895 | 9 208 103 | 20 |
| 1 | 2400 | 9 266 102 | 6 |

| | | | |
|---|-----|-----------|----|
| 2 | 295 | 9 208 089 | 30 |
| 2 | 395 | 9 208 090 | 20 |
| 2 | 445 | 9 208 091 | 20 |
| 2 | 495 | 9 208 092 | 20 |
| 2 | 595 | 9 208 093 | 20 |
| 2 | 795 | 9 208 094 | 20 |
| 2 | 895 | 9 208 095 | 20 |

| | | | |
|---|-----|-----------|----|
| 3 | 295 | 9 266 095 | 30 |
| 3 | 395 | 9 266 096 | 20 |
| 3 | 445 | 9 266 097 | 20 |
| 3 | 495 | 9 266 098 | 20 |
| 3 | 595 | 9 266 099 | 20 |
| 3 | 795 | 9 266 100 | 20 |
| 3 | 895 | 9 266 101 | 20 |

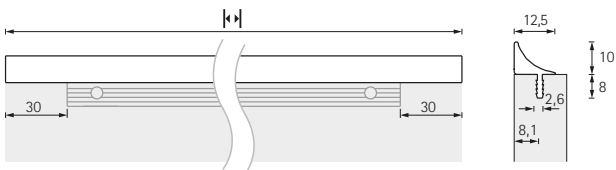

Genzone



- 1 Verchromt glanz
Bright chrome plated
Chromé brillant
Verchromd glans



- 2 Edelfstahl Optik gebürstet
Brushed stainless steel look
Aspect inox brossé
Roestvrij staal finish geborsteld

Capris



- 1 Aluminium eloxiert
Aluminium, anodised
Aluminium anodisé
Aluminium geëloxeerd



- 2 Edelfstahl Optik
Stainless steel look
Aspect inox
Roestvrij staal finish



- 3 Endkappen-Set / Aluminium Optik
Set of end caps / Aluminium look
Kit d'embouts / Aspect aluminium
Eindkappen set / Aluminiumkleurig



- 4 Endkappen-Set / Vernickelt matt Optik
Set of end caps / Matt nickel plated look
Kit d'embouts / Aspect nickelé mat
Eindkappen set / Vernickeld mat

| | | |
|---|-----------|----|
| | | ☐ |
| 1 | 9 145 262 | 50 |
| 2 | 9 145 263 | 50 |

| | | | |
|---|-----------|----|---|
| | | | ☐ |
| 1 | 9 149 293 | 8 | ⊙ |
| 2 | 9 149 296 | 8 | ⊙ |
| 3 | 0 115 028 | 50 | |
| 4 | 0 115 049 | 50 | |

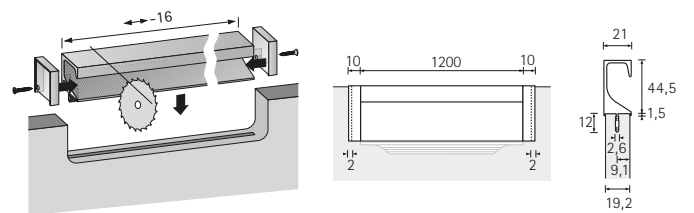
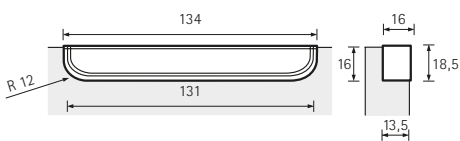

NEW MODERN

Nidum



Aluminium Optik
Aluminium look
Aspect aluminium
Aluminiumkleurig

Spira



1 Aluminium eloxiert
Aluminium, anodised
Aluminium anodisé
Aluminium geëloxeerd



2 Endkappen-Set / Aluminium Optik
Set of end caps / Aluminium look
Kit d'embouts / Aspect aluminium
Eindkappen set / Aluminiumkleurig

| ••• | ••• ₁ | ••• ₂ | | □ |
|-----|------------------|------------------|-----------|----|
| 96 | 111 | 107 | 9 071 060 | 25 |
| 128 | 143 | 139 | 9 071 071 | 25 |
| 160 | 175 | 171 | 9 071 073 | 25 |
| 192 | 207 | 203 | 9 071 075 | 25 |
| 256 | 271 | 267 | 9 071 079 | 50 |
| 320 | 335 | 331 | 9 071 082 | 50 |

| | | □ | ○ |
|---|-----------|-----|---|
| 1 | 0 115 314 | 6 | |
| 2 | 0 115 298 | 100 | |

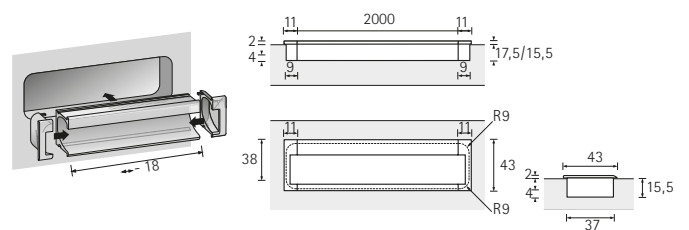
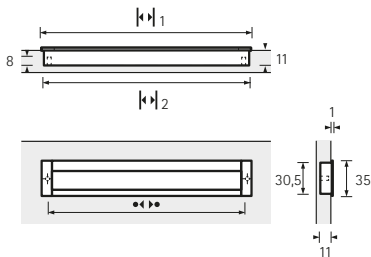

Misia



1 Aluminium Optik
Aluminium look
Aspect aluminium
Aluminiumkleurig



2 Vernickelt matt Optik
Matt nickel plated look
Aspect nickelé mat
Vernikkeld mat

Apolda



1 Edeltahl gebürstet
Brushed stainless steel
Inox brossé
Roestvrij staal geborsteld



2 Edeltahl gebürstet / Schwarz glänzend
Brushed stainless steel / Polished black
Inox brossé / Noir brillant
Roestvrij staal geborsteld / Zwart glanzend

| | ••• | ₁ | ₂ | | □ |
|---|-----|--------------|--------------|-----------|----|
| 1 | 96 | 116 | 111 | 0 115 181 | 50 |
| 1 | 160 | 180 | 176 | 0 115 127 | 25 |
| 2 | 96 | 116 | 111 | 0 115 182 | 50 |
| 2 | 160 | 180 | 176 | 0 115 183 | 25 |

| | | □ |
|---|-----------|----|
| 1 | 9 191 745 | 20 |
| 2 | 9 207 531 | 20 |

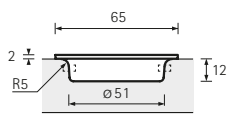
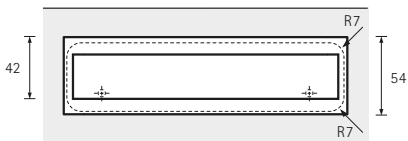
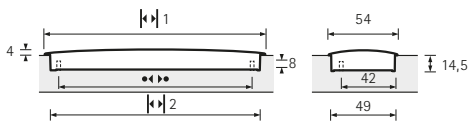

NEW MODERN

Novae



- 1 Verchromt glanz
Bright chrome plated
Chromé brillant
Verchroomd glans
- 2 Vernickelt matt
Matt nickel plated
Nickelé mat
Vernikkeld mat

| | Ø | H | Code | QTY |
|---|------|----|-----------|-----|
| 1 | 19 | 28 | 9 112 634 | 100 |
| 2 | 14,5 | 28 | 9 112 633 | 100 |

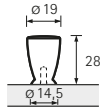

Onex



- Edelstahl gebürstet
Brushed stainless steel
Inox brossé
Roestvrij staal geborsteld

| | Ø | H | Code | QTY |
|--|----|----|-----------|-----|
| | 22 | 30 | 9 113 565 | 100 |

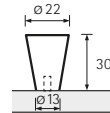

Agrinum



- Edelstahl gebürstet
Brushed stainless steel
Inox brossé
Roestvrij staal geborsteld

| Ø | H | Code | QTY |
|----|----|-----------|-----|
| 14 | 22 | 9 070 263 | 200 |
| 18 | 26 | 9 070 264 | 125 |



Monacum



- Edelstahl gebürstet
Brushed stainless steel
Inox brossé
Roestvrij staal geborsteld

| Ø | H | Code | QTY |
|----|----|-----------|-----|
| 10 | 22 | 9 070 957 | 200 |
| 14 | 26 | 9 070 958 | 150 |



Danum



Edelstahl gebürstet
Brushed stainless steel
Inox brossé
Roestvrij staal geborsteld

| \varnothing_1 | \varnothing_2 | \varnothing_3 | | |
|-----------------|-----------------|-----------------|-----------|-----|
| 20 | 11 | 18 | 9 070 744 | 150 |
| 25 | 14 | 22 | 9 070 740 | 125 |
| 30 | 16 | 26 | 9 070 735 | 75 |



Sion



Edelstahl gebürstet
Brushed stainless steel
Inox brossé
Roestvrij staal geborsteld

| | | | | |
|--|--|--|-----------|-----|
| | | | | |
| | | | 9 113 564 | 100 |

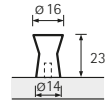

Spalatum



Edelstahl gebürstet
Brushed stainless steel
Inox brossé
Roestvrij staal geborsteld

| | | | | |
|--|--|--|-----------|-----|
| | | | | |
| | | | 9 070 580 | 100 |

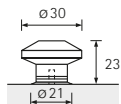

DELUXE



42 Amisia



42 Limpio



43 Istrana



43 Itri



44 Forli



44 Brema



45 Como



45 Utinum



46 Buena



47 Baldone



47 Belluno



48 Cecina



48 Ponte



49 Intra



50 Veronia



50 Basilia



51 Arimini



51 Opera



51 Saturnia



52 Delia



52 Lodi



52 Sava



53 Solda

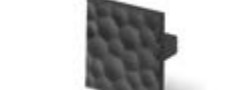

53 Londa



54 Fogo



54 Bona



DELUXE

DELUXE

Amisia



- 1 Verchromt glanz
Bright chrome plated
Chromé brillant
Verchroomd glans



- 2 Edelhstahl Optik gebürstet
Brushed stainless steel look
Aspect inox brossé
Roestvrij staal finish geborsteld

| 1 | 9 190 446 | 25 | |
|---|-----------|----|--|
| 2 | 9 190 445 | 25 | |

Limpio



- 1 Weiß matt
Matt White
Blanc mat
Wit mat



- 2 Schwarz matt
Matt black
Noir mat
Zwart mat

| 1 | 9 266 417 | 25 | |
|---|-----------|----|--|
| 2 | 9 266 418 | 25 | |

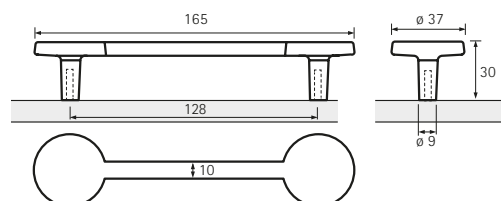
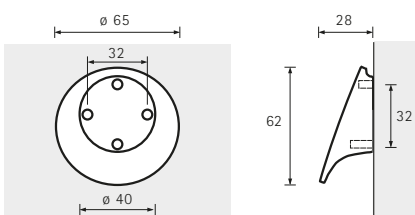

Istrana



Edelstahl Optik gebürstet
Brushed stainless steel look
Aspect inox brossé
Roestvrij staal finish geborsteld

Itri



Edelstahl Optik gebürstet
Brushed stainless steel look
Aspect inox brossé
Roestvrij staal finish geborsteld

DELUXE

| | |
|-----------|----|
| 9 132 312 | 25 |
|-----------|----|

| | |
|-----------|----|
| 9 132 314 | 30 |
|-----------|----|

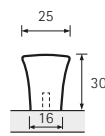
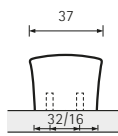
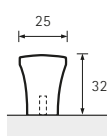
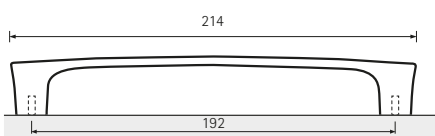

DELUXE

Forli



- 1 Verchromt glanz
Bright chrome plated
Chromé brillant
Verchroomd glans



- 2 Edeltahl Optik gebürstet
Brushed stainless steel look
Aspect inox brossé
Roestvrij staal finish geborsteld

| | | ☐ |
|---|-----------|----|
| 1 | 9 112 660 | 35 |
| 2 | 9 207 488 | 35 |

Brema



- 1 Edeltahl gebürstet /
Edeltahl Optik gebürstet
Brushed stainless steel /
Brushed stainless steel look
Inox brossé / Aspect inox brossé
Roestvrij staal geborsteld /
Roestvrij staal finish geborsteld



- 2 Schwarz matt /
Edeltahl Optik gebürstet
Matt black /
Brushed stainless steel look
Noir mat / Aspect inox brossé
Zwart mat /
Roestvrij staal finish geborsteld

| | ☐ | | ☐ | | ☐ | | ☐ | | |
|---|-----|-----|-----------|----|---|-----|-----|-----------|----|
| 1 | 96 | 108 | 9 118 858 | 25 | 2 | 96 | 108 | 9 264 074 | 25 |
| 1 | 128 | 140 | 9 069 890 | 25 | 2 | 128 | 140 | 9 264 075 | 25 |
| 1 | 160 | 172 | 9 069 893 | 25 | 2 | 160 | 172 | 9 264 076 | 25 |
| 1 | 192 | 204 | 9 070 104 | 25 | 2 | 192 | 204 | 9 264 077 | 25 |
| 1 | 224 | 236 | 9 070 106 | 25 | 2 | 224 | 236 | 9 264 078 | 25 |
| 1 | 256 | 268 | 9 070 107 | 30 | 2 | 256 | 268 | 9 264 079 | 30 |
| 1 | 288 | 300 | 9 070 108 | 30 | 2 | 288 | 300 | 9 264 080 | 30 |
| 1 | 352 | 364 | 9 070 109 | 20 | 2 | 352 | 364 | 9 264 081 | 20 |
| 1 | 416 | 428 | 9 070 110 | 20 | 2 | 416 | 428 | 9 264 082 | 20 |
| 1 | 448 | 460 | 9 070 112 | 20 | 2 | 448 | 460 | 9 264 084 | 20 |
| 1 | 640 | 652 | 9 070 113 | 15 | 2 | 640 | 652 | 9 264 085 | 15 |

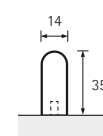
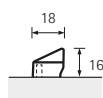
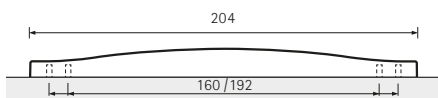

Como



- 1 Edelstahl gebürstet /
Edelstahl Optik gebürstet
Brushed stainless steel /
Brushed stainless steel look
Inox brossé / Aspect inox brossé
Roestvrij staal geborsteld /
Roestvrij staal finish geborsteld



- 2 Schwarz matt
Matt black
Noir mat
Zwart mat

Utinum



- Edelstahl Optik gebürstet
Brushed stainless steel look
Aspect inox brossé
Roestvrij staal finish geborsteld

DELUXE

| | ••• | | | □ |
|---|-----|-----|-----------|----|
| 1 | 192 | 204 | 0 115 077 | 25 |
| 1 | 320 | 332 | 0 115 078 | 20 |
| 2 | 192 | 204 | 9 264 072 | 25 |
| 2 | 320 | 332 | 9 264 073 | 20 |

| | □ |
|--|--------------|
| | 9 109 703 50 |

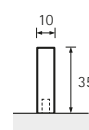
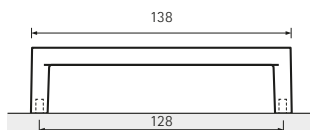
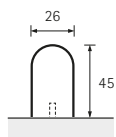
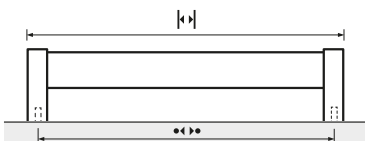

DELUXE

Buena



Kupfer Optik glanz
Bright copper look
Aspect cuivre brillant
Koperkleurig glanzend

9 207 444 75

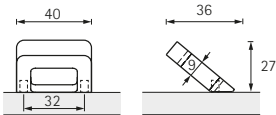

Kupfer Optik glanz
Bright copper look
Aspect cuivre brillant
Koperkleurig glanzend

9 207 445 25

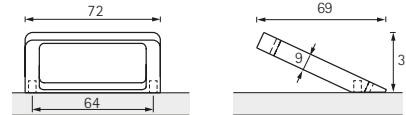

Kupfer Optik glanz
Bright copper look
Aspect cuivre brillant
Koperkleurig glanzend

9 207 446 30

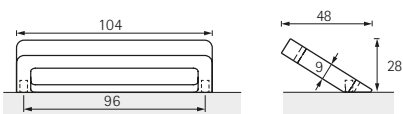

Kupfer Optik glanz
Bright copper look
Aspect cuivre brillant
Koperkleurig glanzend

9 207 447 35

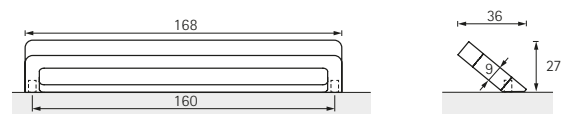

Baldone



1 Verchromt glanz
Bright chrome plated
Chromé brillant
Verchromd glans



2 Verchromt matt
Matt chrome plated
Chromé mat
Verchromd mat



3 Edeltahl Optik gebürstet
Brushed stainless steel look
Aspect inox brossé
Roestvrij staal finish geborsteld



4 Schwarz matt
Matt black
Noir mat
Zwart mat

Belluno



1 Verchromt glanz
Bright chrome plated
Chromé brillant
Verchromd glans



2 Verchromt matt
Matt chrome plated
Chromé mat
Verchromd mat



3 Edeltahl Optik gebürstet
Brushed stainless steel look
Aspect inox brossé
Roestvrij staal finish geborsteld



4 Schwarz matt
Matt black
Noir mat
Zwart mat

| | ••• | • ₁ | • ₂ | ± | □ |
|---|-----|-----------------|-----------------|----|--------------|
| 1 | 96 | 104 | 11 | 26 | 9 995 546 40 |
| 1 | 128 | 136 | 11 | 26 | 9 995 547 30 |
| 1 | 160 | 168 | 11 | 26 | 9 995 780 30 |
| 1 | 256 | 264 | 15 | 29 | 9 995 548 25 |
| 2 | 96 | 104 | 11 | 26 | 9 995 482 40 |
| 2 | 128 | 136 | 11 | 26 | 9 995 480 30 |
| 2 | 160 | 168 | 11 | 26 | 9 995 782 30 |
| 2 | 256 | 264 | 15 | 29 | 9 995 484 25 |
| 3 | 96 | 104 | 11 | 26 | 9 995 483 40 |
| 3 | 128 | 136 | 11 | 26 | 9 995 481 30 |
| 3 | 160 | 168 | 11 | 26 | 9 995 781 30 |
| 3 | 256 | 264 | 15 | 29 | 9 995 485 25 |
| 4 | 96 | 104 | 11 | 26 | 9 269 733 40 |
| 4 | 128 | 136 | 11 | 26 | 9 269 734 30 |
| 4 | 160 | 168 | 11 | 26 | 9 269 735 30 |
| 4 | 256 | 264 | 15 | 29 | 9 269 736 25 |

| | ••• | • | ± | □ |
|---|-----------|-----|----|--------------|
| 1 | 96 | 130 | 28 | 0 043 643 30 |
| 1 | 160 / 192 | 200 | 30 | 0 043 503 40 |
| 1 | 224 / 256 | 267 | 30 | 0 043 506 25 |
| 2 | 96 | 130 | 28 | 0 043 642 30 |
| 2 | 160 / 192 | 200 | 30 | 0 043 502 40 |
| 2 | 224 / 256 | 267 | 30 | 0 043 505 25 |
| 3 | 96 | 130 | 28 | 9 995 771 30 |
| 3 | 160 / 192 | 200 | 30 | 9 995 772 40 |
| 3 | 224 / 256 | 267 | 30 | 9 995 773 25 |
| 4 | 96 | 130 | 28 | 9 270 437 30 |
| 4 | 160 / 192 | 200 | 30 | 9 270 438 40 |
| 4 | 224 / 256 | 267 | 30 | 9 270 439 25 |

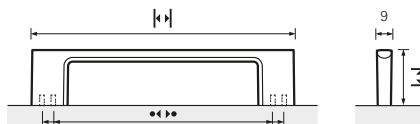
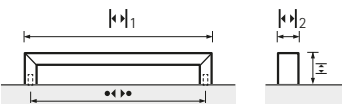

DELUXE

Cecina



1 Champagner / Edelstahl gebürstet
Champagne / Brushed stainless steel
Champagne / Inox brossé
Champagne / Roestvrij staal geborsteld



2 Rot / Edelstahl gebürstet
Red / Brushed stainless steel
Rouge / Inox brossé
Rood / Roestvrij staal geborsteld



3 Blau / Edelstahl gebürstet
Blue / Brushed stainless steel
Bleu / Inox brossé
Blauw / Roestvrij staal geborsteld



4 Anthrazit / Edelstahl gebürstet
Anthracite / Brushed stainless steel
Anthracite / Inox brossé
Antraciet / Roestvrij staal geborsteld

| | | ☐ |
|---|-----------|----|
| 1 | 9 199 093 | 10 |
| 2 | 9 199 030 | 10 |
| 3 | 9 199 091 | 10 |
| 4 | 9 199 092 | 10 |

Ponte



Edelstahl gebürstet
Brushed stainless steel
Inox brossé
Roestvrij staal geborsteld

| ••• | | | ☐ |
|-----|-----|-----------|----|
| 160 | 173 | 0 115 385 | 25 |
| 192 | 205 | 0 115 060 | 50 |
| 320 | 333 | 0 115 387 | 20 |

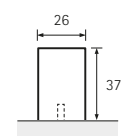
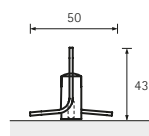
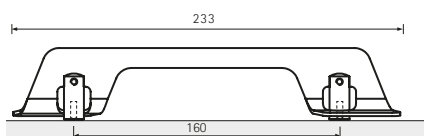

Intra



1 Verchromt glanz / Verchromt matt
Bright chrome plated /
Matt chrome plated
Chromé brillant / Chromé mat
Verchromd glans /
Verchromd mat



5 Edelstahl Optik gebürstet /
Kupfer Optik gebürstet
Brushed stainless steel look /
Brushed copper look
Aspect inox brossé /
Aspect cuivre brossé
Roestvrij staal finish geborsteld /
Koperkleurig geborsteld



2 Verchromt matt / Verchromt glanz
Matt chrome plated /
Bright chrome plated
Chromé mat / Chromé brillant
Verchromd mat /
Verchromd glans



6 Weiß matt / Kupfer Optik gebürstet
Matt white / Brushed copper look
Blanc mat / Aspect cuivre brossé
Wit mat / Koperkleurig geborsteld



3 Edelstahl Optik gebürstet /
Verchromt glanz
Brushed stainless steel look /
Bright chrome plated
Aspect inox brossé / Chromé brillant
Roestvrij staal finish geborsteld /
Verchromd glans



7 Schwarz matt /
Edelstahl Optik gebürstet
Matt black /
Brushed stainless steel look
Noir mat / Aspect inox brossé
Zwart mat /
Roestvrij staal finish geborsteld





4 Edelstahl Optik gebürstet
Brushed stainless steel look
Aspect inox brossé
Roestvrij staal finish geborsteld

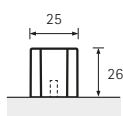
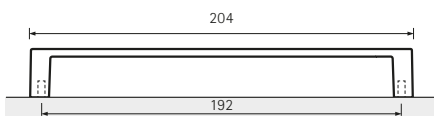

8 Schwarz matt /
Kupfer Optik gebürstet
Matt black /
Brushed copper look
Noir mat / Aspect cuivre brossé
Zwart mat /
Koperkleurig geborsteld



| | |  | |  |
|---|-----------|---|---|---|
| 1 | 9 113 800 | 25 | 5 | 9 207 480 25 |
| 2 | 9 105 737 | 25 | 6 | 9 207 483 25 |
| 3 | 9 105 735 | 25 | 7 | 9 207 481 25 |
| 4 | 9 207 482 | 25 | 8 | 9 264 088 25 |

DELUXE

Veronia



1 Verchromt glanz
Bright chrome plated
Chromé brillant
Verchromd glans



2 Edalstahl Optik gebürstet
Brushed stainless steel look
Aspect inox brossé
Roestvrij staal finish geborsteld

Basilia



Edalstahl Optik gebürstet
Brushed stainless steel look
Aspect inox brossé
Roestvrij staal finish geborsteld

| | ••• | k ₁ | k ₂ | | □ |
|---|-----|----------------|----------------|-----------|----|
| 1 | 128 | 144 | 14 | 9 065 634 | 50 |
| 1 | 160 | 176 | 19 | 9 097 947 | 25 |
| 2 | 128 | 144 | 14 | 9 065 635 | 50 |
| 2 | 160 | 176 | 19 | 9 097 946 | 25 |

| | | □ |
|--|-----------|----|
| | 0 115 076 | 25 |

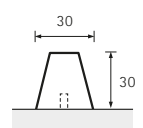
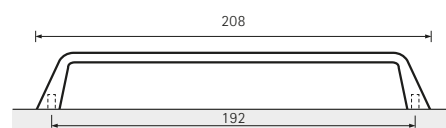
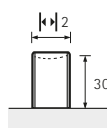
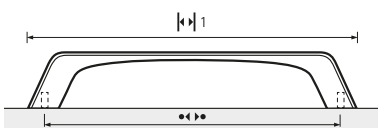

Arimini



1 Verchromt glanz / Weiß
Bright chrome plated / White
Chromé brillant / Blanc
Verchromd glans / Wit



2 Verchromt glanz / Schwarz
Bright chrome plated / Black
Chromé brillant / Noir
Verchromd glans / Zwart

| | | | ☐ |
|---|-----------|-----|---|
| 1 | 9 113 719 | 100 | |
| 2 | 9 112 664 | 100 | |

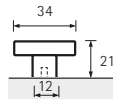

Opera



Verchromt glanz
Bright chrome plated
Chromé brillant
Verchromd glans

| ☐ | ☐ | ☐ | ☐ |
|--------|-----|-----------|----|
| 96/128 | 135 | 9 113 675 | 50 |
| 160 | 200 | 9 113 678 | 25 |
| 192 | 232 | 9 113 681 | 25 |

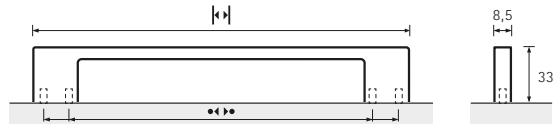

Saturnia



Verchromt glanz
Bright chrome plated
Chromé brillant
Verchromd glans

| | | ☐ |
|-----------|----|---|
| 9 113 712 | 50 | |

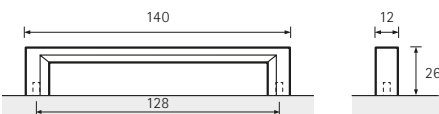

DELUXE

Delia



Verchromt glanz
Bright chrome plated
Chromé brillant
Verchromd glans

| ••• | • | | ☐ |
|-----|-----|-----------|----|
| 128 | 144 | 9 113 685 | 50 |
| 160 | 176 | 9 113 690 | 50 |

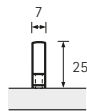
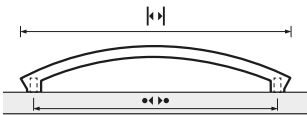

Lodi



1 Verchromt glanz
Bright chrome plated
Chromé brillant
Verchromd glans



2 Gold Optik
Gold look
Aspect or
Goudkleurig

| | | | ☐ |
|---|--|-----------|----|
| 1 | | 9 113 699 | 50 |
| 2 | | 9 113 700 | 50 |

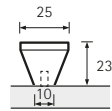

Sava



Verchromt glanz
Bright chrome plated
Chromé brillant
Verchromd glans

| | | | ☐ |
|--|--|-----------|----|
| | | 9 113 696 | 50 |

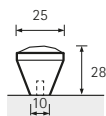

Solda



- 1 Verchromt glanz
Bright chrome plated
Chromé brillant
Verchromd glans



- 2 Schwarz matt
Matt black
Noir mat
Zwart mat

Londa



- 1 Verchromt glanz
Bright chrome plated
Chromé brillant
Verchromd glans

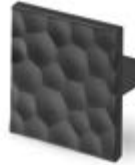

- 2 Schwarz matt
Matt black
Noir mat
Zwart mat

| | | |
|---|-----------|----|
| | | ☐ |
| 1 | 9 113 404 | 20 |
| 2 | 9 269 741 | 20 |

| | | |
|---|-----------|----|
| | | ☐ |
| 1 | 9 113 397 | 20 |
| 2 | 9 269 742 | 20 |

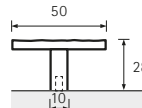
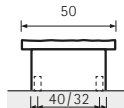
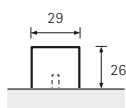
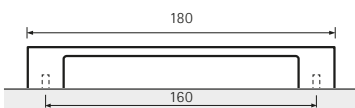

DELUXE

Fogo



Edelstahl Optik gebürstet
Brushed stainless steel look
Aspect inox brossé
Roestvrij staal finish geborsteld

Bona



1 Verchromt glanz
Bright chrome plated
Chromé brillant
Verchromd glans

2 Edelstahl Optik gebürstet
Brushed stainless steel look
Aspect inox brossé
Roestvrij staal finish geborsteld

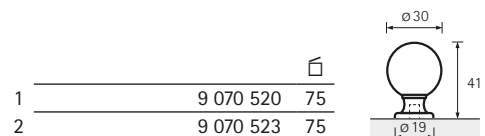

ORGANIC



58 Neapolis



58 Tolfo



58 Athena



59 Borgoa



59 Oli



60 Aboa



60 Felina



61 Coria



61 Parma



62 Balmo



62 Carvo



63 Nicia



64 Bathia



64 Matilo



65 Salona



65 Ovada



66 Fectio



66 Vantania



67 Tolosa



67 Dinia



68 Naila



68 Culmen



69 Vada



70 Avenio



71 Asopus



71 Belna



72 Lucca



72 Catana



73 Chalcis



73 Vieste



74 Suasa



74 Carolina



75 Trento



75 Meana



76 Codania



77 Tardiano



77 Ladera



77 Issa



77 Sipontum



78 Sala



78 Almus



79 Cirpi



79 Serbinum



79 Murcia

ORGANIC

Neapolis



- 1 Verchromt glanz
Bright chrome plated
Chromé brillant
Verchroomd glans



- 2 Edeldahl Optik gebürstet
Brushed stainless steel look
Aspect inox brossé
Roestvrij staal finish geborsteld

| | | |
|---|-----------|----|
| 1 | 0 115 122 | 25 |
| 2 | 9 114 747 | 25 |

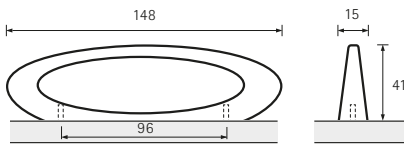

Tolfo



- 1 Verchromt glanz
Bright chrome plated
Chromé brillant
Verchroomd glans



- 2 Edeldahl Optik gebürstet
Brushed stainless steel look
Aspect inox brossé
Roestvrij staal finish geborsteld

| | | |
|---|-----------|----|
| 1 | 9 097 900 | 25 |
| 2 | 9 097 899 | 25 |

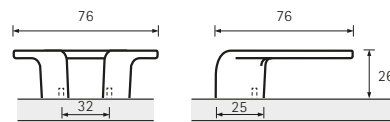

Athena



- 1 Verchromt glanz
Bright chrome plated
Chromé brillant
Verchroomd glans



- 2 Aluminium Optik
Aluminium look
Aspect aluminium
Aluminiumkleurig

| | | |
|---|-----------|----|
| 1 | 9 065 425 | 20 |
| 2 | 9 065 427 | 20 |
| 3 | 9 065 426 | 20 |



- 3 Edeldahl Optik gebürstet
Brushed stainless steel look
Aspect inox brossé
Roestvrij staal finish geborsteld

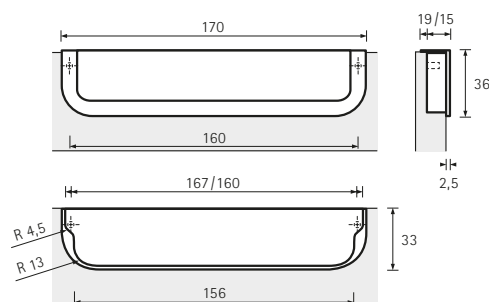

Borgoa



1 Verchromt glanz
Bright chrome plated
Chromé brillant
Verchromd glans



2 Verchromt matt
Matt chrome plated
Chromé mat
Verchromd mat



3 Vernickelt matt
Matt nickel plated
Nickelé mat
Vernikkeld mat



4 Edeldstahl Optik
Stainless steel look
Aspect inox
Roestvrij staal finish

| 1 | 9 070 574 | 75 |
|---|-----------|----|
| 2 | 9 070 567 | 75 |
| 3 | 9 070 565 | 75 |
| 4 | 9 070 556 | 75 |

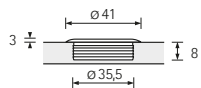

Olivia



1 Verchromt glanz
Bright chrome plated
Chromé brillant
Verchromd glans



2 Aluminium Optik
Aluminium look
Aspect aluminium
Aluminiumkleurig



3 Schwarz matt
Matt black
Noir mat
Zwart mat

| 1 | 9 277 179 | 15 |
|---|-----------|----|
| 2 | 9 266 415 | 15 |
| 3 | 9 266 416 | 15 |

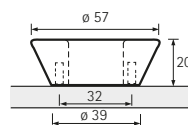

ORGANIC

Aboa



- 1 Edelstahl gebürstet
Brushed stainless steel
Inox brossé
Roestvrij staal geborsteld



- 2 Edelstahl gebürstet / Schwarz glänzend
Brushed stainless steel / Polished black
Inox brossé / Noir brillant
Roestvrij staal geborsteld / Zwart glanzend

| 1 | 9 070 138 | 25 | |
|---|-----------|----|--|
| 2 | 9 207 534 | 25 | |

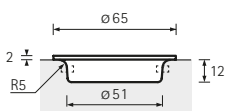

Felina



- 1 Verchromt glanz
Bright chrome plated
Chromé brillant
Verchromd glans



- 2 Edelstahl Optik gebürstet
Brushed stainless steel look
Aspect inox brossé
Roestvrij staal finish geborsteld



- 3 Schwarz matt
Matt black
Noir mat
Zwart mat

| 1 | 9 113 373 | 15 | |
|---|-----------|----|--|
| 2 | 9 113 371 | 15 | |
| 3 | 9 265 887 | 15 | |

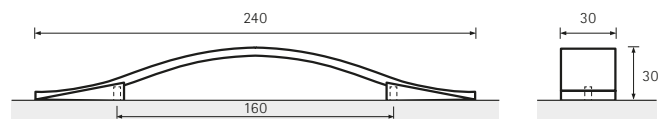

Coria



- 1 Verchromt glanz
Bright chrome plated
Chromé brillant
Verchromd glans



- 2 Verchromt matt
Matt chrome plated
Chromé mat
Verchromd mat



- 3 Vernickelt matt
Matt nickel plated
Nickelé mat
Vernikkeld mat



- 4 Edalstahl Optik gebürstet
Brushed stainless steel look
Aspect inox brossé
Roestvrij staal finish geborsteld

| 1 | 9 070 624 | 50 | |
|---|-----------|----|--|
| 2 | 9 112 597 | 50 | |
| 3 | 9 112 596 | 50 | |
| 4 | 9 112 595 | 50 | |

Parma



- 1 Verchromt glanz
Bright chrome plated
Chromé brillant
Verchromd glans



- 2 Edalstahl Optik gebürstet
Brushed stainless steel look
Aspect inox brossé
Roestvrij staal finish geborsteld

| 1 | 9 113 468 | 50 | |
|---|-----------|----|--|
| 2 | 9 113 467 | 50 | |

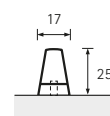
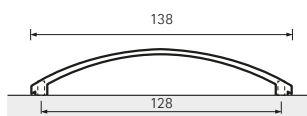
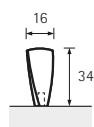
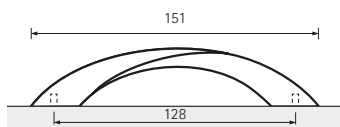

ORGANIC

Balmo



- 1 Verchromt matt
Matt chrome plated
Chromé mat
Verchromd mat



- 2 Edalstahl Optik gebürstet
Brushed stainless steel look
Aspect inox brossé
Roestvrij staal finish geborsteld

Carvo



- Edalstahl Optik gebürstet
Brushed stainless steel look
Aspect inox brossé
Roestvrij staal finish geborsteld

| | | |
|---|-----------|----|
| 1 | 0 074 134 | 25 |
| 2 | 0 043 472 | 25 |

| | |
|-----------|----|
| 9 112 623 | 50 |
|-----------|----|

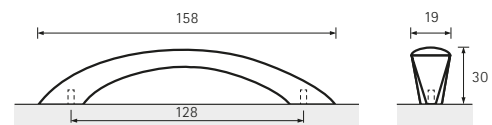
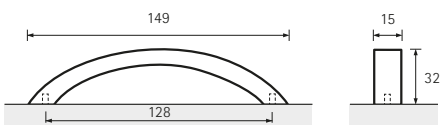

Nicia



1 Verchromt glanz
Bright chrome plated
Chromé brillant
Verchromd glans

| | ••• | | ± | | □ |
|---|-----|-----|----|-----------|----|
| 1 | 96 | 112 | 30 | 9 070 983 | 50 |
| 1 | 128 | 148 | 30 | 9 071 037 | 50 |
| 1 | 160 | 184 | 32 | 9 070 997 | 50 |
| 1 | 192 | 221 | 32 | 9 071 018 | 50 |
| 1 | 224 | 258 | 32 | 9 071 049 | 50 |



2 Verchromt matt
Matt chrome plated
Chromé mat
Verchromd mat

| | | | | | |
|---|-----|-----|----|-----------|----|
| 2 | 96 | 112 | 30 | 9 070 986 | 50 |
| 2 | 128 | 148 | 30 | 9 071 039 | 50 |
| 2 | 160 | 184 | 32 | 9 071 001 | 50 |
| 2 | 192 | 221 | 32 | 9 070 784 | 50 |
| 2 | 224 | 258 | 32 | 9 071 063 | 50 |



3 Vernickelt matt
Matt nickel plated
Nickelé mat
Vernikkeld mat

| | | | | | |
|---|-----|-----|----|-----------|----|
| 3 | 96 | 112 | 30 | 9 071 014 | 50 |
| 3 | 128 | 148 | 30 | 9 070 976 | 50 |
| 3 | 160 | 184 | 32 | 9 071 016 | 50 |
| 3 | 192 | 221 | 32 | 9 071 019 | 50 |
| 3 | 224 | 258 | 32 | 9 070 980 | 50 |



4 Edsstahl Optik gebürstet
Brushed stainless steel look
Aspect inox brossé
Roestvrij staal finish geborsteld

| | | | | | |
|---|-----|-----|----|-----------|----|
| 4 | 96 | 112 | 30 | 9 070 985 | 50 |
| 4 | 128 | 148 | 30 | 9 071 067 | 50 |
| 4 | 160 | 184 | 32 | 9 070 722 | 50 |
| 4 | 192 | 221 | 32 | 9 070 723 | 50 |
| 4 | 224 | 258 | 32 | 9 071 068 | 50 |

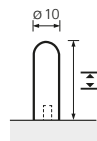
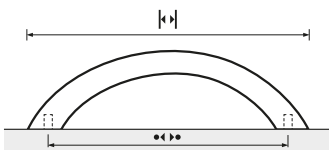

ORGANIC

Bathia



- 1 Verchromt glanz
Bright chrome plated
Chromé brillant
Verchroomd glans



- 2 Edeltahl Optik gebürstet
Brushed stainless steel look
Aspect inox brossé
Roestvrij staal finish geborsteld

Matilo



- 1 Verchromt matt
Matt chrome plated
Chromé mat
Verchroomd mat



- 2 Vernickelt matt
Matt nickel plated
Nickelé mat
Vernikkeld mat



- 3 Edeltahl Optik gebürstet
Brushed stainless steel look
Aspect inox brossé
Roestvrij staal finish geborsteld

| | ••• | • | | □ |
|---|-----|-----|-----------|----|
| 1 | 96 | 118 | 9 070 492 | 50 |
| 1 | 128 | 151 | 9 070 508 | 50 |
| 2 | 96 | 118 | 9 070 493 | 50 |
| 2 | 128 | 151 | 9 070 516 | 50 |

| | | □ |
|---|-----------|----|
| 1 | 9 112 914 | 50 |
| 2 | 0 115 195 | 50 |
| 3 | 9 206 642 | 50 |

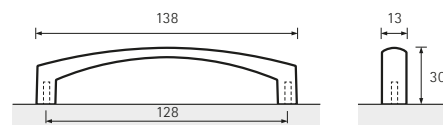
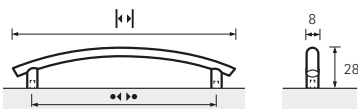

Salona



Edelstahl Optik gebürstet
Brushed stainless steel look
Aspect inox brossé
Roestvrij staal finish geborsteld

Ovada



1 Verchromt glanz
Bright chrome plated
Chromé brillant
Verchromd glans



2 Edelstahl Optik gebürstet
Brushed stainless steel look
Aspect inox brossé
Roestvrij staal finish geborsteld

| | | | | ☐ |
|---|-----|-----|----|---|
| 1 | 170 | 155 | 30 | |

| | | ☐ | | | ☐ |
|---|-----------|-----|-----------|----|---|
| 1 | 96 | 139 | 9 118 524 | 50 | |
| 1 | 160 / 192 | 266 | 9 118 521 | 50 | |
| 1 | 256 / 320 | 362 | 9 118 518 | 25 | |
| 2 | 96 | 139 | 9 118 523 | 50 | |
| 2 | 160 / 192 | 266 | 9 118 520 | 50 | |
| 2 | 256 / 320 | 362 | 9 118 517 | 25 | |

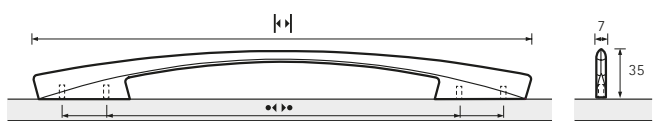
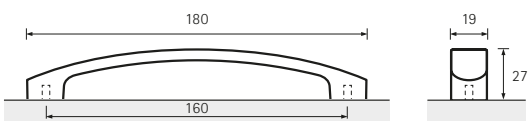

ORGANIC

Fectio



- 1 Verchromt matt
Matt chrome plated
Chromé mat
Verchromd mat



- 2 Edeltahl Optik gebürstet
Brushed stainless steel look
Aspect inox brossé
Roestvrij staal finish geborsteld

| 1 | 9 112 615 | 50 | |
|---|-----------|----|--|
| 2 | 9 112 613 | 50 | |

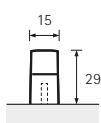
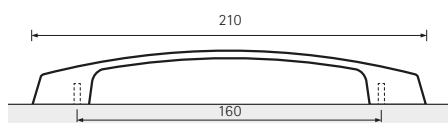

Vantania



- 1 Verchromt glanz
Bright chrome plated
Chromé brillant
Verchromd glans



- 2 Verchromt matt
Matt chrome plated
Chromé mat
Verchromd mat



- 3 Edeltahl Optik gebürstet
Brushed stainless steel look
Aspect inox brossé
Roestvrij staal finish geborsteld

| 1 | 9 113 211 | 25 | |
|---|-----------|----|--|
| 2 | 9 113 210 | 25 | |
| 3 | 1 170 158 | 25 | |

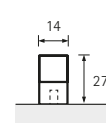
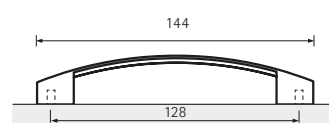

Tolosa



1 Verchromt matt
Matt chrome plated
Chromé mat
Verchromd mat



2 Vernickelt matt
Matt nickel plated
Nickelé mat
Vernikkeld mat

Dinia



1 Verchromt matt
Matt chrome plated
Chromé mat
Verchromd mat



2 Edalstahl Optik gebürstet
Brushed stainless steel look
Aspect inox brossé
Roestvrij staal finish geborsteld

| | ••• | | | □ |
|---|-----|-----|-----------|----|
| 1 | 96 | 126 | 9 112 910 | 30 |
| 1 | 128 | 157 | 9 112 909 | 25 |
| 2 | 96 | 126 | 0 115 203 | 30 |
| 2 | 128 | 157 | 9 113 514 | 25 |

| | ••• | ₁ | ₂ | □ | □ |
|---|-----|--------------|--------------|-----------|----|
| 1 | 96 | 118 | 16 28 | 9 070 754 | 75 |
| 1 | 128 | 143 | 18 29 | 9 070 752 | 50 |
| 2 | 96 | 118 | 16 28 | 9 070 675 | 75 |
| 2 | 128 | 143 | 18 29 | 9 070 681 | 50 |

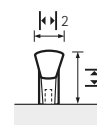
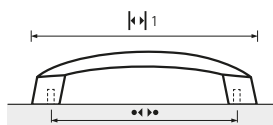
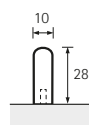
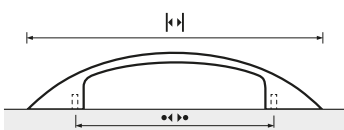

ORGANIC

Naila



1 Aluminium eloxiert
Aluminium, anodised
Aluminium anodisé
Aluminium geëloxeerd



2 Braun metallic gebürstet
Brown metallic brushed
Brun métallique brossé
Bruin metallic geborsteld



3 Schwarz matt
Matt black
Noir mat
Zwart mat

Culmen



1 Aluminium eloxiert
Aluminium, anodised
Aluminium anodisé
Aluminium geëloxeerd



2 Edeldstahl Optik gebürstet
Brushed stainless steel look
Aspect inox brossé
Roestvrij staal finish geborsteld

| | ••• | • | | □ |
|---|-----|-----|-----------|----|
| 1 | 64 | 71 | 9 190 399 | 50 |
| 1 | 96 | 103 | 9 190 421 | 50 |
| 1 | 128 | 135 | 9 190 422 | 50 |
| 1 | 160 | 167 | 9 190 423 | 50 |
| 1 | 192 | 199 | 9 190 424 | 50 |
| 1 | 256 | 263 | 9 190 425 | 50 |
| 1 | 288 | 295 | 9 190 426 | 50 |
| 1 | 320 | 327 | 9 190 427 | 50 |
| | | | | |
| 2 | 64 | 71 | 9 190 428 | 50 |
| 2 | 96 | 103 | 9 190 429 | 50 |
| 2 | 128 | 135 | 9 190 430 | 50 |
| 2 | 160 | 167 | 9 190 431 | 50 |
| 2 | 192 | 199 | 9 190 432 | 50 |
| 2 | 256 | 263 | 9 190 433 | 50 |
| 2 | 288 | 295 | 9 190 434 | 50 |
| 2 | 320 | 327 | 9 190 435 | 50 |

| | ••• | • | | □ |
|---|-----|-----|-----------|----|
| 3 | 64 | 71 | 9 266 077 | 50 |
| 3 | 96 | 103 | 9 266 078 | 50 |
| 3 | 128 | 135 | 9 266 079 | 50 |
| 3 | 160 | 167 | 9 266 080 | 50 |
| 3 | 192 | 199 | 9 266 091 | 50 |
| 3 | 256 | 263 | 9 266 092 | 50 |
| 3 | 288 | 295 | 9 266 093 | 50 |
| 3 | 320 | 327 | 9 266 094 | 50 |

| | ••• | • | | □ |
|---|-----|-----|-----------|----|
| 1 | 96 | 104 | 0 115 146 | 50 |
| 1 | 128 | 136 | 0 115 147 | 50 |
| 1 | 160 | 168 | 0 115 148 | 50 |
| 1 | 192 | 200 | 0 115 149 | 50 |
| 1 | 224 | 232 | 0 115 150 | 50 |
| 1 | 288 | 296 | 0 115 152 | 50 |
| 1 | 352 | 360 | 0 115 153 | 25 |
| | | | | |
| 2 | 96 | 104 | 9 206 115 | 50 |
| 2 | 128 | 136 | 9 206 116 | 50 |
| 2 | 160 | 168 | 9 206 117 | 50 |
| 2 | 192 | 200 | 9 206 119 | 50 |
| 2 | 224 | 232 | 9 206 120 | 50 |
| 2 | 288 | 296 | 9 206 122 | 50 |
| 2 | 352 | 360 | 9 206 124 | 25 |

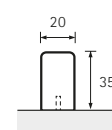
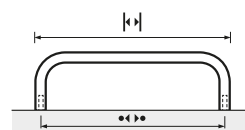
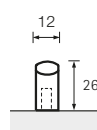
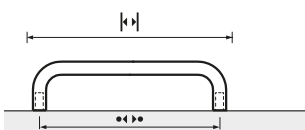

Vada



Edelstahl gebürstet
Brushed stainless steel
Inox brossé
Roestvrij staal geborsteld

| «» | «» | ☒ | | ☐ |
|-----|-----|----|-----------|----|
| 64 | 75 | 30 | 9 070 440 | 75 |
| 96 | 111 | 30 | 9 070 446 | 50 |
| 128 | 149 | 30 | 9 070 501 | 50 |
| 160 | 184 | 32 | 9 070 451 | 50 |
| 192 | 222 | 32 | 9 070 457 | 50 |
| 224 | 260 | 32 | 9 070 504 | 50 |
| 256 | 297 | 32 | 9 070 466 | 50 |
| 288 | 335 | 32 | 9 070 509 | 50 |
| 320 | 368 | 34 | 9 070 481 | 50 |
| 352 | 392 | 41 | 9 070 494 | 50 |

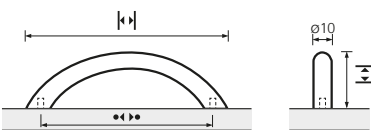

ORGANIC

Avenio



1 Verchromt glanz
Bright chrome plated
Chromé brillant
Verchromd glans



2 Verchromt matt
Matt chrome plated
Chromé mat
Verchromd mat



3 Vernickelt matt
Matt nickel plated
Nickelé mat
Vernikkeld mat



4 Edelfstahl Optik gebürstet
Brushed stainless steel look
Aspect inox brossé
Roestvrij staal finish geborsteld

| | Ø | ••• | | | □ |
|-------|----|-----|-----|-----------|----|
| 1 | 8 | 64 | 72 | 9 070 605 | 50 |
| 1 | 8 | 96 | 104 | 9 070 602 | 50 |
| 1 | 8 | 128 | 136 | 9 070 075 | 50 |
| 1 | 10 | 64 | 74 | 9 070 443 | 50 |
| 1 | 10 | 96 | 106 | 9 070 519 | 50 |
| 1 | 10 | 128 | 138 | 9 070 625 | 50 |
| 1 | 10 | 160 | 170 | 9 070 548 | 75 |
| 1 | 10 | 192 | 202 | 9 069 899 | 50 |
| 1 | 10 | 288 | 298 | 9 069 922 | 50 |
| 1 | 10 | 352 | 362 | 9 069 900 | 25 |
| <hr/> | | | | | |
| 2 | 8 | 64 | 72 | 9 069 943 | 50 |
| 2 | 8 | 96 | 104 | 9 070 054 | 50 |
| 2 | 8 | 128 | 136 | 9 070 078 | 50 |
| 2 | 10 | 64 | 74 | 9 070 444 | 50 |
| 2 | 10 | 96 | 106 | 9 070 521 | 50 |
| 2 | 10 | 128 | 138 | 9 070 540 | 50 |
| 2 | 10 | 160 | 170 | 9 070 552 | 75 |
| 2 | 10 | 192 | 202 | 9 070 572 | 50 |
| 2 | 10 | 288 | 298 | 9 069 877 | 50 |
| 2 | 10 | 352 | 362 | 9 069 892 | 25 |
| <hr/> | | | | | |
| 3 | 8 | 64 | 72 | 9 069 919 | 50 |
| 3 | 8 | 96 | 104 | 9 069 915 | 50 |
| 3 | 8 | 128 | 136 | 9 069 907 | 50 |
| 3 | 10 | 64 | 74 | 9 070 511 | 50 |
| 3 | 10 | 96 | 106 | 9 070 522 | 50 |
| 3 | 10 | 128 | 138 | 9 070 619 | 50 |
| 3 | 10 | 160 | 170 | 9 069 909 | 75 |
| 3 | 10 | 192 | 202 | 9 069 868 | 50 |
| 3 | 10 | 288 | 298 | 9 069 867 | 50 |
| 3 | 10 | 352 | 362 | 9 069 873 | 25 |
| <hr/> | | | | | |
| 4 | 8 | 64 | 72 | 9 070 030 | 50 |
| 4 | 8 | 96 | 104 | 9 070 439 | 50 |
| 4 | 8 | 128 | 136 | 9 070 429 | 50 |
| 4 | 10 | 64 | 74 | 9 070 512 | 50 |
| 4 | 10 | 96 | 106 | 9 070 527 | 50 |
| 4 | 10 | 128 | 138 | 9 070 448 | 50 |
| 4 | 10 | 160 | 170 | 9 070 557 | 75 |
| 4 | 10 | 192 | 202 | 9 070 577 | 50 |
| 4 | 10 | 288 | 298 | 9 069 927 | 50 |
| 4 | 10 | 352 | 362 | 9 070 025 | 25 |

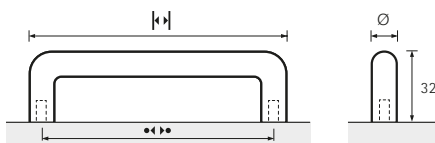

Asopus



Edelstahl gebürstet
Brushed stainless steel
Inox brossé
Roestvrij staal geborsteld

Belna



Edelstahl Optik gebürstet
Brushed stainless steel look
Aspect inox brossé
Roestvrij staal finish geborsteld

| Ø | ••• | | ≡ | | □ |
|----|-----|-----|----|-----------|----|
| 8 | 64 | 72 | 32 | 9 070 096 | 50 |
| 8 | 96 | 104 | 32 | 9 069 942 | 50 |
| 8 | 128 | 136 | 32 | 9 070 101 | 50 |
| 10 | 96 | 106 | 32 | 9 069 815 | 50 |
| 10 | 128 | 138 | 32 | 9 069 818 | 50 |
| 10 | 160 | 170 | 32 | 9 070 124 | 75 |
| 10 | 192 | 202 | 32 | 9 070 420 | 50 |
| 10 | 224 | 234 | 32 | 9 069 821 | 50 |
| 10 | 320 | 330 | 32 | 9 069 865 | 50 |
| 10 | 352 | 362 | 32 | 9 070 421 | 25 |
| 12 | 96 | 108 | 40 | 9 070 102 | 50 |
| 12 | 128 | 140 | 40 | 9 070 103 | 50 |
| 12 | 160 | 172 | 40 | 9 070 117 | 50 |
| 12 | 192 | 204 | 40 | 9 070 105 | 50 |
| 12 | 224 | 236 | 40 | 9 070 118 | 50 |
| 12 | 320 | 332 | 40 | 9 070 119 | 50 |
| 12 | 352 | 364 | 40 | 9 070 111 | 25 |
| 12 | 480 | 492 | 40 | 9 070 120 | 25 |
| 12 | 704 | 716 | 40 | 9 070 122 | 25 |

| ••• | | | □ |
|-----|-----|-----------|----|
| 128 | 135 | 0 115 169 | 50 |
| 160 | 167 | 0 115 170 | 50 |

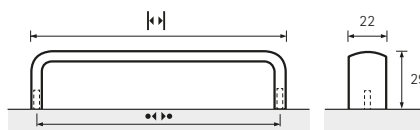
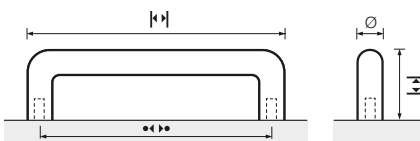

ORGANIC

Lucca



- 1 Verchromt glanz
Bright chrome plated
Chromé brillant
Verchroomd glans



- 2 Edeltahl Optik gebürstet
Brushed stainless steel look
Aspect inox brossé
Roestvrij staal finish geborsteld

| | | | ☐ |
|---|-----------|----|---|
| 1 | 9 113 510 | 25 | |
| 2 | 9 113 511 | 25 | |

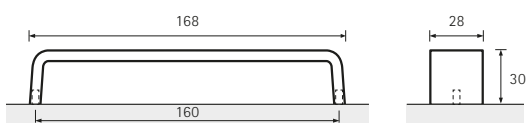

Catana



- 1 Aluminium eloxiert
Aluminium, anodised
Aluminium anodisé
Aluminium geëloxeerd



- 2 Edeltahl Optik gebürstet
Brushed stainless steel look
Aspect inox brossé
Roestvrij staal finish geborsteld

| | ••• | • | | ☐ |
|---|---------|-----------|----|---|
| 1 | 192 199 | 9 113 733 | 25 | |
| 1 | 320 327 | 9 113 734 | 25 | |
| 2 | 192 199 | 0 115 080 | 25 | |
| 2 | 320 327 | 0 115 081 | 25 | |

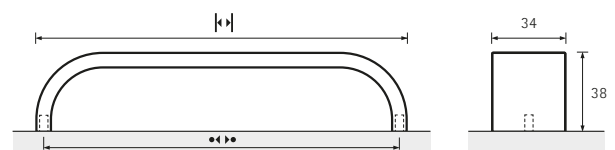

Chalcis



Edelstahl Optik gebürstet
Brushed stainless steel look
Aspect inox brossé
Roestvrij staal finish geborsteld

Vieste



Edelstahl Optik gebürstet
Brushed stainless steel look
Aspect inox brossé
Roestvrij staal finish geborsteld

| ••• | • | | □ |
|-----|-----|-----------|----|
| 128 | 147 | 9 113 183 | 40 |
| 288 | 301 | 9 113 182 | 40 |

| ••• | • | | □ |
|-----|-----|-----------|----|
| 96 | 120 | 9 995 497 | 20 |
| 128 | 152 | 9 995 498 | 15 |
| 160 | 184 | 9 995 499 | 25 |
| 192 | 216 | 9 995 500 | 20 |
| 224 | 248 | 9 995 501 | 20 |

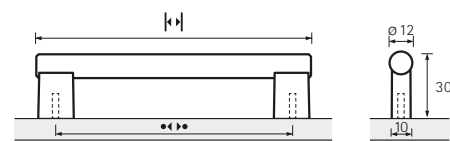
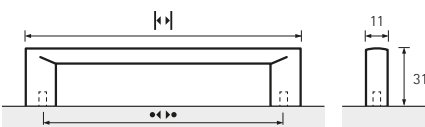

ORGANIC

Suasa



- 1 Verchromt glanz
Bright chrome plated
Chromé brillant
Verchroomd glans



- 2 Edeltahl Optik gebürstet
Brushed stainless steel look
Aspect inox brossé
Roestvrij staal finish geborsteld

Carolina



- 1 Verchromt glanz
Bright chrome plated
Chromé brillant
Verchroomd glans



- 2 Edeltahl Optik gebürstet
Brushed stainless steel look
Aspect inox brossé
Roestvrij staal finish geborsteld

| | | ☐ |
|---|-----------|----|
| 1 | 9 112 916 | 25 |
| 2 | 9 112 915 | 25 |

| | | ☐ |
|---|-----------|----|
| 1 | 9 080 858 | 50 |
| 2 | 9 080 859 | 50 |

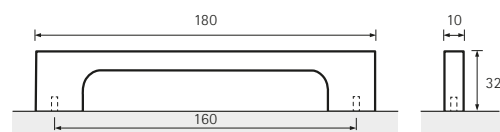
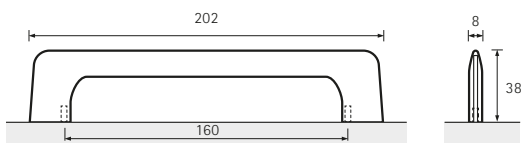

Trento



1 Verchromt glanz
Bright chrome plated
Chromé brillant
Verchromd glans



2 Edalstahl Optik gebürstet
Brushed stainless steel look
Aspect inox brossé
Roestvrij staal finish geborsteld

Meana



Edalstahl Optik gebürstet
Brushed stainless steel look
Aspect inox brossé
Roestvrij staal finish geborsteld

| | ••• | • | | □ |
|---|-----|-----|-----------|-----|
| 1 | 32 | 93 | 9 070 095 | 100 |
| 1 | 96 | 171 | 9 070 123 | 50 |
| 2 | 32 | 93 | 9 070 121 | 100 |
| 2 | 96 | 171 | 9 070 125 | 50 |

| | □ |
|--|--------------|
| | 9 114 539 25 |

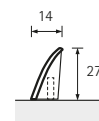
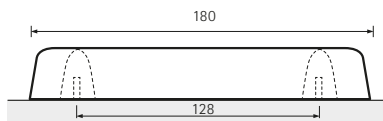
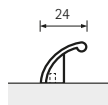
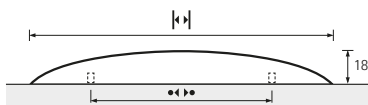

ORGANIC

Codania



- 1 Edelstahl Optik gebürstet
Brushed stainless steel look
Aspect inox brossé
Roestvrij staal finish geborsteld



- 2 Schwarz matt
Matt black
Noir mat
Zwart mat



- 3 Gold Optik matt gebürstet
Gold look matt brushed
Aspect doré brossé mat
Goudkleurig mat geborsteld

| | k ₁ | k ₂ | | □ |
|---|----------------|----------------|-----------|----|
| 1 | 295 | 236 | 9 209 994 | 50 |
| 1 | 345 | 275 | 9 209 995 | 25 |
| 1 | 395 | 315 | 9 209 996 | 25 |
| 1 | 445 | 355 | 9 209 997 | 25 |
| 1 | 495 | 395 | 9 210 058 | 25 |
| 1 | 595 | 475 | 9 210 059 | 25 |
| 1 | 795 | 635 | 9 210 060 | 25 |
| 1 | 895 | 715 | 9 210 061 | 25 |
| 1 | 995 | 795 | 9 210 062 | 25 |
| 1 | 1195 | 954 | 9 210 063 | 20 |

| | k ₁ | k ₂ | | □ |
|---|----------------|----------------|-----------|----|
| 2 | 295 | 236 | 9 265 997 | 50 |
| 2 | 345 | 275 | 9 265 998 | 25 |
| 2 | 395 | 315 | 9 265 999 | 25 |
| 2 | 445 | 355 | 9 266 000 | 25 |
| 2 | 495 | 395 | 9 266 001 | 25 |
| 2 | 595 | 475 | 9 266 002 | 25 |
| 2 | 795 | 635 | 9 266 003 | 25 |
| 2 | 895 | 715 | 9 266 004 | 25 |
| 2 | 995 | 795 | 9 266 005 | 25 |
| 2 | 1195 | 954 | 9 266 006 | 20 |

| | k ₁ | k ₂ | | □ |
|---|----------------|----------------|-----------|----|
| 3 | 295 | 236 | 9 266 067 | 50 |
| 3 | 345 | 275 | 9 266 068 | 25 |
| 3 | 395 | 315 | 9 266 069 | 25 |
| 3 | 445 | 355 | 9 266 070 | 25 |
| 3 | 495 | 395 | 9 266 071 | 25 |
| 3 | 595 | 475 | 9 266 072 | 25 |
| 3 | 795 | 635 | 9 266 073 | 25 |
| 3 | 895 | 715 | 9 266 074 | 25 |
| 3 | 995 | 795 | 9 266 075 | 25 |
| 3 | 1195 | 954 | 9 266 076 | 20 |

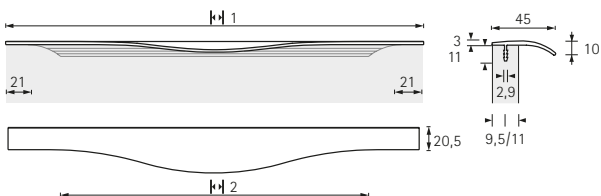

Tardiano



- 1 Edelstahl Optik gebürstet
Brushed stainless steel look
Aspect inox brossé
Roestvrij staal finish geborsteld



- 2 Schwarz matt
Matt black
Noir mat
Zwart mat

| | | |
|---|-----------|----|
| 1 | 9 266 141 | 25 |
| 2 | 9 266 142 | 25 |

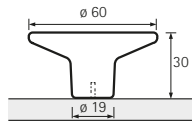

Ladera



- Vernickelt matt
Matt nickel plated
Nickelé mat
Vernikkeld mat

| | |
|-----------|----|
| 9 112 644 | 50 |
|-----------|----|

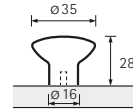

Issa



- 1 Verchromt glanz
Bright chrome plated
Chromé brillant
Verchromd glans



- 2 Edelstahl Optik gebürstet
Brushed stainless steel look
Aspect inox brossé
Roestvrij staal finish geborsteld



- 3 Schwarz matt
Matt black
Noir mat
Zwart mat

| | | |
|---|-----------|----|
| 1 | 9 203 958 | 50 |
| 2 | 0 115 312 | 50 |
| 3 | 9 265 885 | 50 |

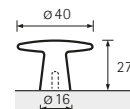

Sipontum



- Edelstahl gebürstet
Brushed stainless steel
Inox brossé
Roestvrij staal geborsteld

| | |
|-----------|----|
| 9 070 568 | 75 |
|-----------|----|

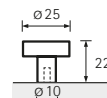

ORGANIC

Sala



- 1 Verchromt glanz
Bright chrome plated
Chromé brillant
Verchromd glans



- 2 Messing Optik glanz
Bright brass look
Aspect laiton brillant
Messingkleurig glanzend

| | | |
|---|-----------|----|
| 1 | 9 071 110 | 75 |
| 2 | 9 071 109 | 75 |

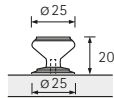

Almus



- 1 Verchromt glanz
Bright chrome plated
Chromé brillant
Verchromd glans



- 2 Verchromt matt
Matt chrome plated
Chromé mat
Verchromd mat



- 3 Vernickelt matt
Matt nickel plated
Nickelé mat
Vernikkeld mat



- 4 Edeldstahl Optik gebürstet
Brushed stainless steel look
Aspect inox brossé
Roestvrij staal finish geborsteld



- 5 Kupfer Optik glanz
Bright copper look
Aspect cuivre brillant
Koperkleurig glanzend

| | | |
|---|-----------|----|
| 1 | 9 112 583 | 50 |
| 2 | 9 112 590 | 50 |
| 3 | 9 112 588 | 50 |
| 4 | 9 114 036 | 50 |
| 5 | 9 204 136 | 50 |

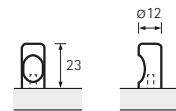

Cirpi



1 Weiß
White
Blanc
Wit



2 Verchromt glanz
Bright chrome plated
Chromé brillant
Verchromd glans



3 Verchromt matt
Matt chrome plated
Chromé mat
Verchromd mat



4 Vernickelt matt
Matt nickel plated
Nickelé mat
Vernikkeld mat



5 Edelstahl Optik gebürstet
Brushed stainless steel look
Aspect inox brossé
Roestvrij staal finish geborsteld

| 1 | 9 070 589 | 30 | |
|---|-----------|----|--|
| 2 | 9 070 585 | 30 | |
| 3 | 9 070 581 | 30 | |
| 4 | 9 070 586 | 30 | |
| 5 | 9 206 738 | 30 | |

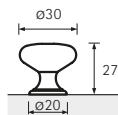

Serbinum



Edelstahl gebürstet
Brushed stainless steel
Inox brossé
Roestvrij staal geborsteld

| | | |
|-----------|----|--|
| 9 070 562 | 75 | |
|-----------|----|--|

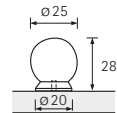

Murcia



Verchromt glanz
Bright chrome plated
Chromé brillant
Verchromd glans

| | | |
|-----------|----|--|
| 9 207 443 | 75 | |
|-----------|----|--|

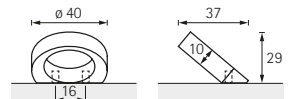

FOLK



82 Cato



85 Luro



87 Topeka



90 Valentia



93 Ogulin



82 Calili



85 Tarraco



88 Siradia



91 Egara



94 Meduno



83 Ponzone



85 Pomezia



88 Sertao



91 Bruxella



94 Flavia



83 Ponti



85 Potovio



89 Haida



92 Salacia



94 Emo



84 Corduba



86 Barcino



89 Terranda



92 Eburaco



95 Bevipo



84 Vesontio



86 Bracara



89 Gissi



92 Savelli



95 Dipo



84 Ponoka



86 Olisipo



89 Osimo



92 Salemi



96 Byzantia



84 Oka



87 Arezzo



90 Malaca



93 Alberta



96 Getafe



97 Gela



97 Galati



98 Nica



98 Filaga



99 Agna



99 Agliano



99 Dublina



99 Arago



100 Lorica



100 Matane



100 Dodona



101 Essa



101 Tonala



102 Galleno



102 Fossa



102 Solva



103 Altedo



103 Larru

FOLK

Cato



Zinn Optik antik
Antique pewter look
Aspect étain antique
Tinkleurig antiek

Calili



Zinn Optik antik
Antique pewter look
Aspect étain antique
Tinkleurig antiek

9 208 030 30

9 208 068 100

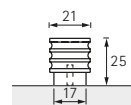
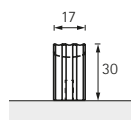
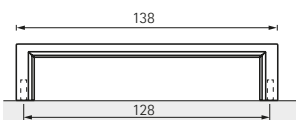

Ponzone



1 Zinn Optik antik
Antique pewter look
Aspect étain antique
Tinkleurig antiek



2 Bronze Optik antik
Antique bronze look
Aspect bronze antique
Bronskleurig antiek

Ponti



1 Zinn Optik antik
Antique pewter look
Aspect étain antique
Tinkleurig antiek



2 Bronze Optik antik
Antique bronze look
Aspect bronze antique
Bronskleurig antiek

| 1 | 9 206 136 | 50 | | |
|---|-----------|----|--|--|
| 2 | 9 113 430 | 50 | | |

| 1 | 9 206 134 | 200 | | |
|---|-----------|-----|--|--|
| 2 | 9 113 429 | 200 | | |

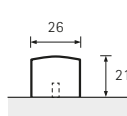
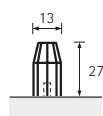
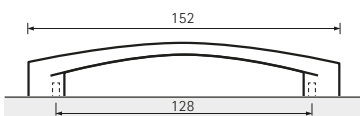

FOLK

Corduba



Zinn Optik
Pewter effect
Aspect étain
Tinkleurig

| | | |
|-----------|----|---|
| | | ☐ |
| 0 115 266 | 50 | |

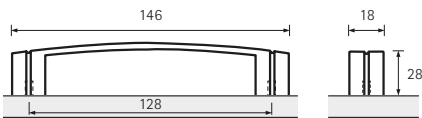

Vesontio



Zinn Optik
Pewter effect
Aspect étain
Tinkleurig

| | | |
|-----------|----|---|
| | | ☐ |
| 9 112 635 | 25 | |

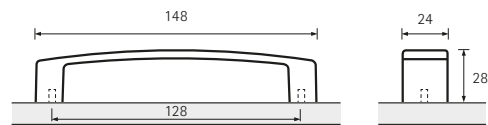

Ponoka



1 Verchromt glanz
Bright chrome plated
Chromé brillant
Verchromd glans



2 Zinn Optik
Pewter effect
Aspect étain
Tinkleurig

| | | |
|-------------|----|---|
| | | ☐ |
| 1 9 080 851 | 50 | |
| 2 9 080 850 | 50 | |

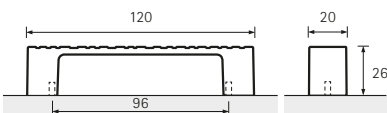

Oka



1 Verchromt glanz
Bright chrome plated
Chromé brillant
Verchromd glans



2 Zinn Optik
Pewter effect
Aspect étain
Tinkleurig

| | | |
|-------------|-----|---|
| | | ☐ |
| 1 9 080 852 | 100 | |
| 2 9 080 853 | 100 | |

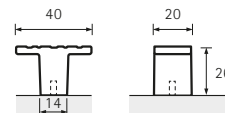

Luro



1 Zinn Optik
Pewter effect
Aspect étain
Tinkleurig



2 Messing Optik antik
Antique brass look
Aspect laiton antique
Messingkleurig antiek



3 Schwarz matt Vintage
Matt black vintage
Noir mat vintage
Zwart mat vintage

| | | | ☐ |
|---|-----------|----|---|
| 1 | 9 112 601 | 50 | |
| 2 | 9 206 237 | 50 | |
| 3 | 9 206 239 | 50 | |

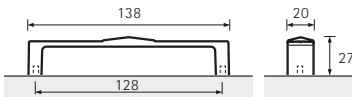

Tarraco



1 Zinn Optik
Pewter effect
Aspect étain
Tinkleurig



2 Messing Optik antik
Antique brass look
Aspect laiton antique
Messingkleurig antiek



3 Schwarz matt Vintage
Matt black vintage
Noir mat vintage
Zwart mat vintage

| | | | ☐ |
|---|-----------|----|---|
| 1 | 9 112 607 | 40 | |
| 2 | 9 206 137 | 40 | |
| 3 | 9 206 138 | 40 | |

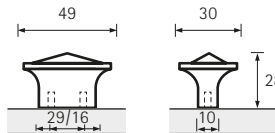

Pomezia



Messing Optik antik
Antique brass look
Aspect laiton antique
Messingkleurig antiek

| ☐ | ☐ | ☐ | ☐ |
|-----|-----|-----------|----|
| 96 | 104 | 9 266 566 | 25 |
| 128 | 136 | 9 266 567 | 20 |
| 160 | 168 | 9 266 568 | 25 |

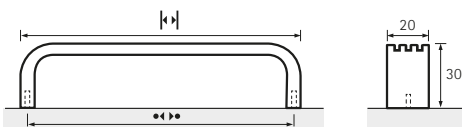

Potovio



Zinn Optik
Pewter effect
Aspect étain
Tinkleurig

| | | ☐ |
|-----------|----|---|
| 9 112 650 | 50 | |

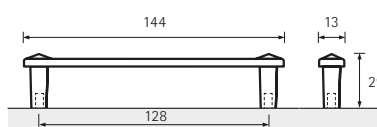

FOLK

Barcino



1 Zinn Optik
Pewter effect
Aspect étain
Tinkleurig



2 Messing Optik antik
Antique brass look
Aspect laiton antique
Messingkleurig antiek



3 Schwarz matt Vintage
Matt black vintage
Noir mat vintage
Zwart mat vintage

| | □ | | |
|---|-----------|-----|--|
| 1 | 9 112 652 | 100 | |
| 2 | 9 206 130 | 100 | |
| 3 | 9 206 131 | 100 | |

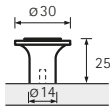

Bracara



1 Zinn Optik
Pewter effect
Aspect étain
Tinkleurig



2 Messing Optik antik
Antique brass look
Aspect laiton antique
Messingkleurig antiek



3 Schwarz matt Vintage
Matt black vintage
Noir mat vintage
Zwart mat vintage

| | □ | □ | □ | □ | □ | □ |
|---|-----|-----|----|-----------|----|---|
| 1 | 96 | 114 | 32 | 9 112 631 | 50 | |
| 1 | 128 | 150 | 33 | 9 112 600 | 50 | |
| 2 | 96 | 114 | 32 | 9 206 126 | 50 | |
| 2 | 128 | 150 | 33 | 9 206 127 | 50 | |
| 3 | 96 | 114 | 32 | 9 206 128 | 50 | |
| 3 | 128 | 150 | 33 | 9 206 129 | 50 | |

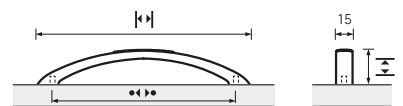

Olisipo



1 Zinn Optik
Pewter effect
Aspect étain
Tinkleurig



2 Zinn Optik
Pewter look
Aspect étain
Tinkleurig

| | □ | |
|---|-----------|----|
| 1 | 0 115 374 | 25 |
| 2 | 9 112 632 | 50 |

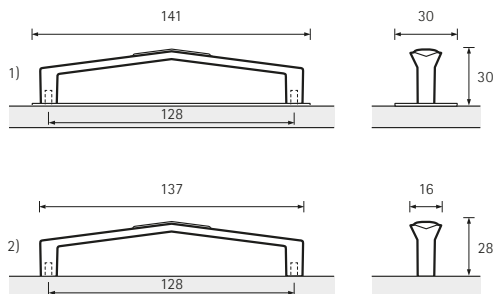

Arezzo



Zinn Optik
Pewter effect
Aspect étain
Tinkleurig

Topeka



Schwarz matt
Matt black
Noir mat
Zwart mat

| | | | |
|-----------|----|--|---|
| | | | ☐ |
| 9 264 060 | 25 | | |

| | | | |
|-----|-----|-----------|----|
| ••• | ☐ | | ☐ |
| 96 | 160 | 9 266 419 | 25 |
| 128 | 192 | 9 266 420 | 25 |
| 160 | 224 | 9 270 230 | 25 |

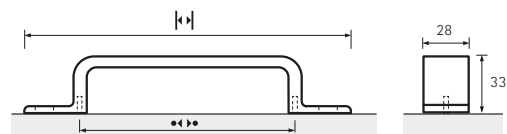
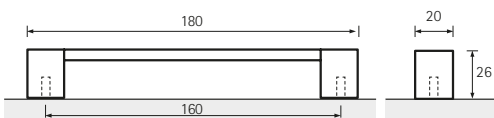

FOLK

Siradia



- 1 Zinn Optik antik
Antique pewter look
Aspect étain antique
Tinkleurig antiek



- 2 Messing Optik antik
Antique brass look
Aspect laiton antique
Messingleurig antiek

Sertao



- 1 Zinn Optik antik
Antique pewter look
Aspect étain antique
Tinkleurig antiek



- 2 Messing Optik antik
Antique brass look
Aspect laiton antique
Messingleurig antiek

| | | ☐ |
|---|-----------|----|
| 1 | 9 208 026 | 25 |
| 2 | 9 208 027 | 25 |

| | | ☐ |
|---|-----------|----|
| 1 | 9 208 064 | 40 |
| 2 | 9 208 065 | 40 |

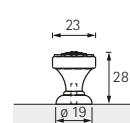
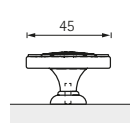
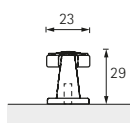
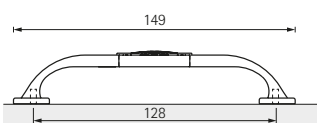

Haida



- 1 Edelstahl Optik gebürstet
Brushed stainless steel look
Aspect inox brossé
Roestvrij staal finish geborsteld



- 2 Messing Optik antik gebürstet
Brushed antique brass look
Aspect laiton antique brossé
Messingkleurig antiek geborsteld

| | | |
|---|-----------|----|
| 1 | 9 113 225 | 50 |
| 2 | 9 113 227 | 50 |

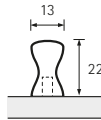
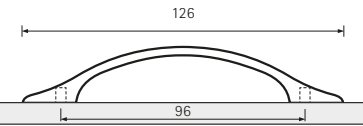

Terranda



- Edelstahl Optik gebürstet
Brushed stainless steel look
Aspect inox brossé
Roestvrij staal finish geborsteld

| | | | | |
|-----|-----|----|-----------|----|
| 96 | 112 | 24 | 9 113 327 | 50 |
| 128 | 146 | 28 | 9 113 292 | 40 |

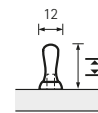
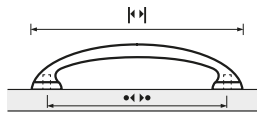

Gissi



- Zinn Optik
Pewter effect
Aspect étain
Tinkleurig

| | |
|-----------|-----|
| 9 112 651 | 100 |
|-----------|-----|

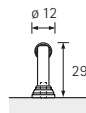
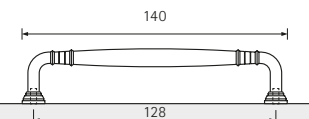

Osimo



- 1 Zinn Optik antik
Antique pewter look
Aspect étain antique
Tinkleurig antiek



- 2 Messing Optik antik
Antique brass look
Aspect laiton antique
Messingkleurig antiek

| | | |
|---|-----------|----|
| 1 | 9 113 445 | 50 |
| 2 | 9 113 444 | 50 |

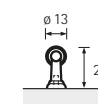
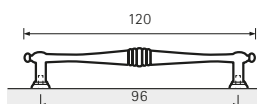

FOLK

Malaca



1 Zinn Optik
Pewter effect
Aspect étain
Tinkleurig



2 Messing Optik antik
Antique brass look
Aspect laiton antique
Messingleurig antiek

Valentia



1 Zinn Optik
Pewter effect
Aspect étain
Tinkleurig



2 Messing Optik antik
Antique brass look
Aspect laiton antique
Messingleurig antiek

| | | | ☐ |
|---|-----------|----|---|
| 1 | 9 070 943 | 50 | |
| 2 | 9 070 945 | 50 | |

| | | | ☐ |
|---|-----------|----|---|
| 1 | 9 070 510 | 75 | |
| 2 | 9 070 513 | 75 | |

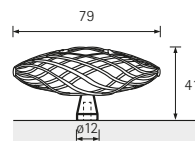
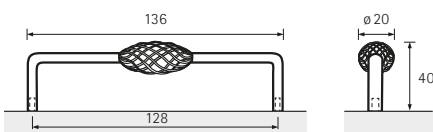

Egara



- 1 Zinn Optik gebürstet
Brushed pewter effect
Aspect étain brossé
Tinkleurig geborsteld



- 2 Messing Optik antik gebürstet
Brushed antique brass look
Aspect laiton antique brossé
Messingkleurig antiek geborsteld



- 3 Bronze Optik antik gebürstet
Brushed antique bronze look
Aspect bronze antique brossé
Bronskleurig antiek geborsteld

| 1 | 9 071 720 | 20 | |
|---|-----------|----|--|
| 2 | 9 071 719 | 20 | |
| 3 | 9 071 718 | 20 | |

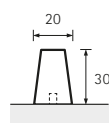
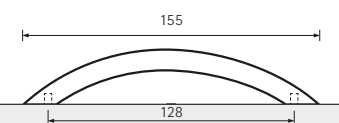

Bruxella



- Edelstahl Optik gebürstet
Brushed stainless steel look
Aspect inox brossé
Roestvrij staal finish geborsteld

| | 9 112 619 | 50 |
|--|-----------|----|

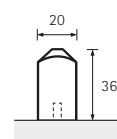
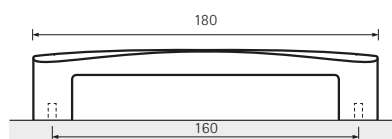

FOLK

Salacia



1 Silber Optik antik
Antique silver look
Aspect argent antique
Zilverkleurig antiek



2 Zinn Optik
Pewter effect
Aspect étain
Tinkleurig

| | ••• | ₁ | ₂ | | □ |
|---|-----|--------------|--------------|-----------|----|
| 1 | 128 | 151 | 23 | 9 112 594 | 50 |
| 2 | 128 | 151 | 23 | 9 112 591 | 50 |

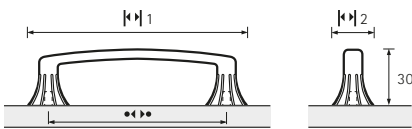

Eburaco



1 Silber Optik antik
Antique silver look
Aspect argent antique
Zilverkleurig antiek



2 Zinn Optik
Pewter effect
Aspect étain
Tinkleurig

| | | □ |
|---|-----------|-----|
| 1 | 9 112 654 | 100 |
| 2 | 9 112 653 | 100 |

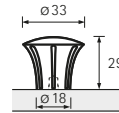

Savelli



Edelstahl Optik gebürstet
Brushed stainless steel look
Aspect inox brossé
Roestvrij staal finish geborsteld

| | □ |
|-----------|----|
| 9 113 483 | 50 |

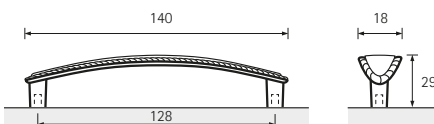

Salemi



Edelstahl Optik gebürstet
Brushed stainless steel look
Aspect inox brossé
Roestvrij staal finish geborsteld

| | □ |
|-----------|----|
| 9 113 368 | 75 |

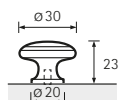

Alberta



1 Edelstahl Optik gebürstet
Brushed stainless steel look
Aspect inox brossé
Roestvrij staal finish geborstelt



2 Messing Optik antik
Antique brass look
Aspect laiton antique
Messingkleurig antiek



3 Zinn Optik antik
Antique pewter look
Aspect étain antique
Tinkleurig antiek

| 1 | 9 113 181 | 50 | |
|---|-----------|----|--|
| 2 | 9 113 179 | 50 | |
| 3 | 9 113 180 | 50 | |

Ogulin



Zinn Optik antik
Antique pewter look
Aspect étain antique
Tinkleurig antiek

| 128 | 152 | 9 266 562 | 30 | |
|-----|-----|-----------|----|--|
| 160 | 184 | 9 266 563 | 20 | |
| 192 | 216 | 9 266 564 | 20 | |
| 224 | 248 | 9 266 565 | 20 | |

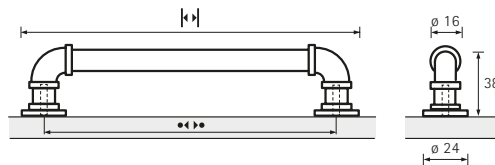
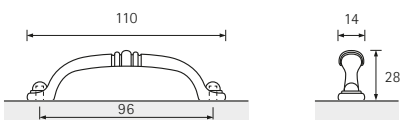

FOLK

Meduno



Zinn Optik
Pewter effect
Aspect étain
Tinkleurig

| | | |
|---|---------|----|
| | | ☐ |
| 9 | 112 662 | 50 |

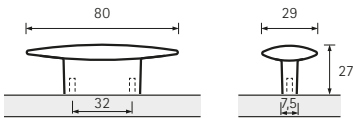

Emo



Edelstahl Optik gebürstet
Brushed stainless steel look
Aspect inox brossé
Roestvrij staal finish geborsteld

| | | |
|---|---------|----|
| | | ☐ |
| 1 | 170 173 | 40 |

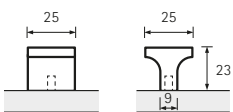

Flavia



1 Vernickelt matt
Matt nickel plated
Nickelé mat
Vernikkeld mat



2 Zinn Optik
Pewter effect
Aspect étain
Tinkleurig

| | | |
|---|-----------|----|
| | | ☐ |
| 1 | 0 115 293 | 50 |
| 2 | 0 115 292 | 50 |

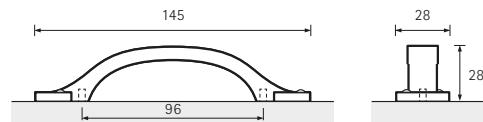

Bevipo



Zinn Optik
Pewter effect
Aspect étain
Tinkleurig

Dipo



Zinn Optik
Pewter effect
Aspect étain
Tinkleurig

0 115 263 50

0 115 264 100

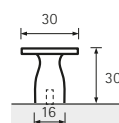
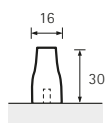
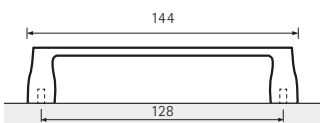

FOLK

Byzantia



- 1 Echtleder dunkelbraun /
Edelstahl Optik gebürstet
Dark brown leather /
Brushed stainless steel look
Cuir à dessins brun foncé /
Aspect inox brossé
Donkerbruin leer /
Roestvrij staal finish geborsteld



- 2 Echtleder dunkelbraun gemustert /
Edelstahl Optik gebürstet
Patterned dark brown leather /
Brushed stainless steel look
Cuir brun foncé à dessins /
Aspect inox brossé
Donkerbruin leer dessin /
Roestvrij staal finish geborsteld



- 3 Echtleder schwarz /
Edelstahl Optik gebürstet
Black leather /
Brushed stainless steel look
Cuir noir / Aspect inox brossé
Zwart leer / Roestvrij staal finish
geborsteld

Getafe



- 1 Echtleder hellbraun /
Edelstahl gebürstet
Light brown leather /
Brushed stainless steel
Cuir brun clair / Inox brossé
Lichtbruin leer /
Roestvrij staal geborsteld



- 2 Echtleder dunkelbraun /
Edelstahl gebürstet
Dark brown leather /
Brushed stainless steel
Cuir brun foncé / Inox brossé
Donkerbruin leer /
Roestvrij staal geborsteld



- 3 Echtleder schwarz / Edelstahl gebürstet
Black leather / Brushed stainless steel
Cuir noir / Inox brossé
Zwart leer / Roestvrij staal geborsteld

| | ••• | • | | □ |
|---|-----|-----|-----------|----|
| 1 | 128 | 188 | 9 070 143 | 40 |
| 1 | 160 | 220 | 9 070 148 | 40 |
| 2 | 128 | 188 | 9 070 144 | 40 |
| 2 | 160 | 220 | 9 070 149 | 40 |
| 3 | 128 | 188 | 9 070 142 | 40 |
| 3 | 160 | 220 | 9 070 147 | 40 |

| | ••• | • | | □ |
|---|-----|-----|-----------|----|
| 1 | 160 | 170 | 9 131 321 | 50 |
| 1 | 224 | 234 | 9 131 324 | 50 |
| 2 | 160 | 170 | 9 131 320 | 50 |
| 2 | 224 | 234 | 9 131 323 | 50 |
| 3 | 160 | 170 | 9 131 319 | 50 |
| 3 | 224 | 234 | 9 131 322 | 50 |

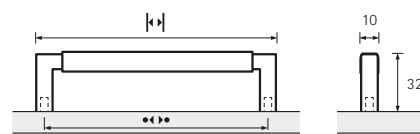
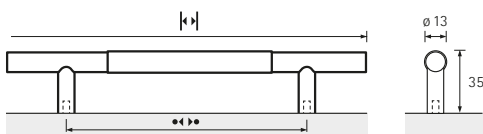

Gela



- 1 Echtleder hellbraun
Light brown leather
Cuir brun clair
Lichtbruin leer



- 2 Echtleder dunkelbraun
Dark brown leather
Cuir brun foncé
Donkerbruin leer



- 3 Echtleder schwarz
Black leather
Cuir noir
Zwart leer

Befestigungssockel siehe Seite 112
For attachment base, see page 112
Socle de fixation voir page 112
Voor bevestigingsvoet zie pagina 112

| 1 | 9 113 645 | 100 | □ |
|---|-----------|-----|---|
| 2 | 9 113 646 | 100 | |
| 3 | 9 113 647 | 100 | |

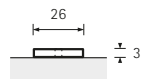
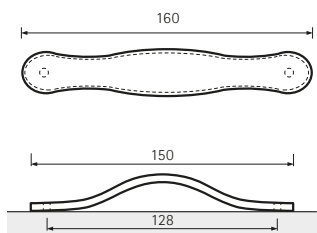

Galati



- 1 Echtleder hellbraun
Light brown leather
Cuir brun clair
Lichtbruin leer



- 2 Echtleder dunkelbraun
Dark brown leather
Cuir brun foncé
Donkerbruin leer



- 3 Echtleder schwarz
Black leather
Cuir noir
Zwart leer

Befestigungssockel siehe Seite 112
For attachment base, see page 112
Socle de fixation voir page 112
Voor bevestigingsvoet zie pagina 112

| 1 | 9 113 648 | 200 | □ |
|---|-----------|-----|---|
| 2 | 9 113 649 | 200 | |
| 3 | 9 113 650 | 200 | |

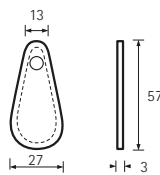

FOLK

Nica



1 Echtleder hellbraun
Light brown leather
Cuir brun clair
Lichtbruin leer



2 Echtleder dunkelbraun
Dark brown leather
Cuir brun foncé
Donkerbruin leer



3 Echtleder schwarz
Black leather
Cuir noir
Zwart leer

Befestigungsschraube siehe Seite 112
For fixing screw, see page 112
Vis de fixation, voir page 112
Voor bevestigingsschroef zie pagina 112

| | ••• | k ₁ | k ₂ | □ |
|---|-----|----------------|----------------|---------------|
| 1 | 64 | 94 | 126 | 9 071 842 100 |
| 1 | 96 | 126 | 158 | 9 071 839 100 |
| 1 | 128 | 158 | 190 | 9 071 836 100 |
| 2 | 64 | 94 | 126 | 9 071 843 100 |
| 2 | 96 | 123 | 158 | 9 071 840 100 |
| 2 | 128 | 158 | 190 | 9 071 837 100 |
| 3 | 64 | 94 | 126 | 9 071 844 100 |
| 3 | 96 | 126 | 158 | 9 071 841 100 |
| 3 | 128 | 158 | 190 | 9 071 838 100 |

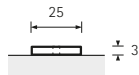
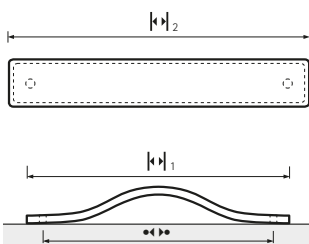

Filaga



1 Echtleder hellbraun / Vernickelt matt
Light brown leather / Matt nickel plated
Cuir brun clair / Nickelé mat
Lichtbruin leer / Vernikkeld mat



2 Echtleder dunkelbraun / Vernickelt matt
Dark brown leather / Matt nickel plated
Cuir brun foncé / Nickelé mat
Donkerbruin leer / Vernikkeld mat



3 Echtleder schwarz / Vernickelt matt
Black leather / Matt nickel plated
Cuir noir / Nickelé mat
Zwart leer / Vernikkeld mat

| | □ |
|---|---------------|
| 1 | 9 113 691 175 |
| 2 | 9 113 594 175 |
| 3 | 9 113 694 175 |

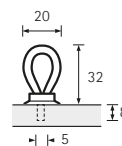

FOLK

Lorica



Zinn Optik
Pewter effect
Aspect étain
Tinkleurig

| | |
|-----------|----|
| | ☐ |
| 9 112 655 | 50 |

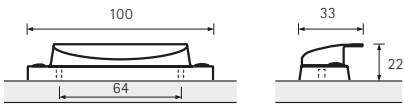

Matane



1 Edelstahl Optik gebürstet
Brushed stainless steel look
Aspect inox brossé
Roestvrij staal finish geborsteld



2 Schwarz matt
Matt black
Noir mat
Zwart mat

| | | |
|---|-----------|----|
| | | ☐ |
| 1 | 9 113 228 | 50 |
| 2 | 9 260 744 | 50 |

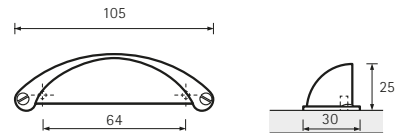

Dodona



Edelstahl gebürstet
Brushed stainless steel
Inox brossé
Roestvrij staal geborsteld

| | |
|-----------|----|
| | ☐ |
| 9 070 693 | 50 |

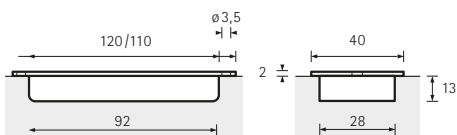

Essa



1 Zinn Optik
Pewter effect
Aspect étain
Tinkleurig



2 Messing Optik antik
Antique brass look
Aspect laiton antique
Messingkleurig antiek



3 Kupfer Optik antik
Antique copper look
Aspect cuivre antique
Koperkleurig antiek



4 Zinn Optik antik
Antique pewter look
Aspect étain antique
Tinkleurig antiek

| | | | ☐ |
|---|-----------|----|---|
| 1 | 9 113 222 | 50 | |
| 2 | 9 113 221 | 50 | |
| 3 | 9 113 223 | 50 | |
| 4 | 9 113 220 | 50 | |

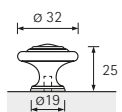

Tonala



Schwarz matt
Matt black
Noir mat
Zwart mat

| | | | ☐ |
|--|-----------|----|---|
| | 9 266 561 | 50 | |

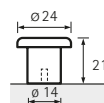

FOLK

Galleno



- 1 Verchromt glanz
Bright chrome plated
Chromé brillant
Verchroomd glans



- 2 Vernickelt matt
Matt nickel plated
Nickelé mat
Vernikkeld mat



- 3 Edelfstahl Optik gebürstet
Brushed stainless steel look
Aspect inox brossé
Roestvrij staal finish geborsteld

| | | | |
|---|-----------|-----|--|
| | | | |
| 1 | 9 206 133 | 100 | |
| 2 | 9 112 599 | 100 | |
| 3 | 9 206 132 | 100 | |

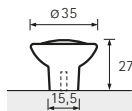

Fossa



- Zinn Optik
Pewter effect
Aspect étain
Tinkleurig

| | | | |
|--|-----------|-----|--|
| | | | |
| | 9 112 646 | 100 | |

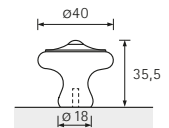

Solva



- 1 Messing Optik glanz
Bright brass look
Aspect laiton brillant
Messingkleurig glanzend



- 2 Messing Optik antik
Antique brass look
Aspect laiton antique
Messingkleurig antiek

| | | | |
|---|-----------|----|--|
| | | | |
| 1 | 9 070 575 | 75 | |
| 2 | 9 113 286 | 75 | |

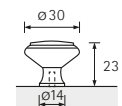

Altedo



1 Edelstahl Optik gebürstet
Brushed stainless steel look
Aspect inox brossé
Roestvrij staal finish geborsteld



2 Zinn Optik antik
Antique pewter look
Aspect étain antique
Tinkleurig antiek



3 Schwarz matt
Matt black
Noir mat
Zwart mat

Larru



Zinn Optik gebürstet
Brushed pewter effect
Aspect étain brossé
Tinkleurig geborsteld

| | | ☐ |
|---|-----------|----|
| 1 | 9 113 293 | 50 |
| 2 | 9 204 153 | 50 |
| 3 | 9 265 886 | 50 |

| | | |
|--|-----------|---------|
| | 9 113 659 | ☐ 75 |
|--|-----------|---------|

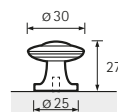
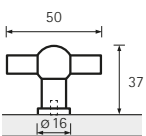

TOUCH-IN

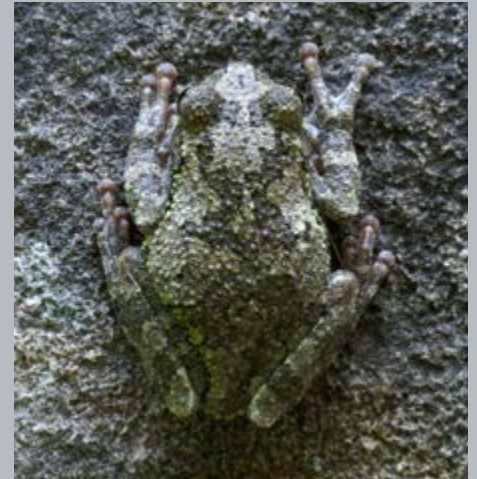

Schafft Gestaltungsfreiheit in Form und Farbe
Creates design flexibility in shape and colour
Pour agir en toute liberté au niveau de la forme et de la couleur
Biedt vrijheid bij de vormgeving, zowel qua vorm als kleur

Das besondere Grifferlebnis

In nahezu grifflos erscheinenden Fronten verbirgt sich, so einfach wie raffiniert, die Grifffunktion von Touch-in. Mit den modularen oder einbaufertigen Griffen können Sie vielfältige Varianten realisieren – designgleich zur Front oder kontrastierend. Touch-in-Griffe können vom Verarbeiter in Frontfarbe lackiert oder mit einem Wunschdekor beschichtet werden.

The unique handle experience

Ingeniously yet with amazing simplicity, the Touch-in handle function is concealed in front panels that almost seem to be handleless. The modular or ready to install handles give you a wide choice of design options – matching the front panel or contrasting with it. Touch-in handles can be lacquered by the fabricator in front panel colour or finished in any chosen decor.

Une expérience particulière avec les poignées

La fonctionnalité de la poignée Touch-in est dissimulée simplement et subtilement dans les façades paraissant presque dépourvues de poignées. Les poignées modulaires ou prêtes à être posées vous permettent de concevoir d'innombrables variantes – soit en parfaite harmonie avec la façade, soit en contraste. Les professionnels du meuble peuvent laquer les poignées Touch-in dans la couleur de la façade ou les revêtir d'un décor personnalisé.

De bijzondere greepbeleving

In vrijwel greeploos ogende fronten gaat, zowel eenvoudig als geraffineerd, de greepfunctie van Touch-in schuil. Met de modulaire of inbouwklare grepen kunt u veelzijdig variëren – in hetzelfde design als het front of contrasterend. Touch-in grepen kunnen in de frontkleur worden gelakt of met een decor naar eigen wens worden bekleed.

Touch-in einbaufertig
ready to install
prêt à être incorporé
kant-en-klaar



1 Verchromt glanz
Bright chrome plated
Chromé brillant
Verchromd glans



2 Edelstahl Optik gebürstet
Brushed stainless-steel look
Aspect inox brossé
Roestvrij staal finish geborsteld



1 Verchromt glanz
Bright chrome plated
Chromé brillant
Verchromd glans



2 Edelstahl Optik gebürstet
Brushed stainless-steel look
Aspect inox brossé
Roestvrij staal finish geborsteld

| | | |
|---|-----------|----|
| 1 | 9 086 690 | 25 |
| 2 | 9 086 689 | 25 |

| | | |
|---|-----------|----|
| 1 | 9 086 688 | 25 |
| 2 | 9 086 687 | 25 |

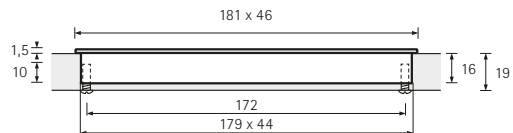
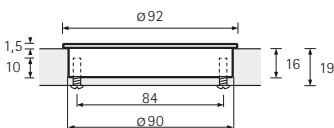

TOUCH-IN

Touch-in modular
modular
modulaire
modulair



- 1 Verchromt glanz
Bright chrome plated
Chromé brillant
Verchromd glans



- 2 Edelhstahl Optik gebürstet
Brushed stainless-steel look
Aspect inox brossé
Roestvrij staal finish geborsteld



- 1 Verchromt glanz
Bright chrome plated
Chromé brillant
Verchromd glans



- 2 Edelhstahl Optik gebürstet
Brushed stainless-steel look
Aspect inox brossé
Roestvrij staal finish geborsteld

| 1 | 9 086 694 | 25 | |
|---|-----------|----|--|
| 2 | 9 086 693 | 25 | |

| 1 | 9 086 692 | 25 | |
|---|-----------|----|--|
| 2 | 9 086 691 | 25 | |

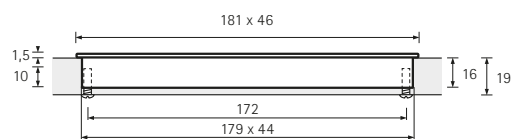
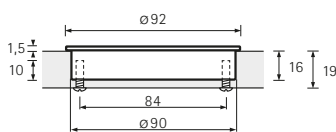

Touch-in modular
modular
modulaire
modulair

Dekorelemente (ABS) zum Selbstlackieren
Trim panels (ABS) for laquer coating
Élément décoratif (ABS) à laquer soi-même
Decoratief element (ABS) om zelf te lakken



- 1 Kunststoff unbeschichtet
Uncoated plastic
Plastique non revêtu
Kunststof ongecoat



- 1 Kunststoff unbeschichtet
Uncoated plastic
Plastique non revêtu
Kunststof ongecoat

Dekorelemente für den Einsatz von Schichtstoff
Trim panels for applying laminate
Éléments pour la mise en œuvre de stratifié
Decoratief element voor het gebruik van eigen materiaal



- 2 Verchromt glanz
Bright chrome plated
Chromé brillant
Verchromd glans



- 2 Verchromt glanz
Bright chrome plated
Chromé brillant
Verchromd glans



- 3 Edelstahl Optik
Stainless steel look
Aspect inox
Roestvrij staal finish



- 3 Edelstahl Optik
Stainless steel look
Aspect inox
Roestvrij staal finish

| | | |
|---|-----------|----|
| 1 | 9 086 698 | 25 |
| 2 | 9 086 702 | 25 |
| 3 | 9 086 701 | 25 |

| | | |
|---|-----------|----|
| 1 | 9 086 695 | 25 |
| 2 | 9 086 697 | 25 |
| 3 | 9 086 696 | 25 |

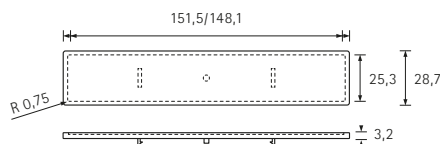
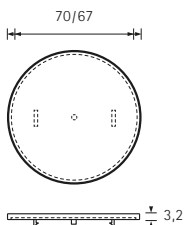

TOUCH-IN

Touch-in modular modular modulaire modulair

Dekorelemente (ABS) zum Selbstlackieren
Trim panels (ABS) for laquer coating
Élément décoratif (ABS) à laquer soi-même
Decoratief element (ABS) om zelf te lakken

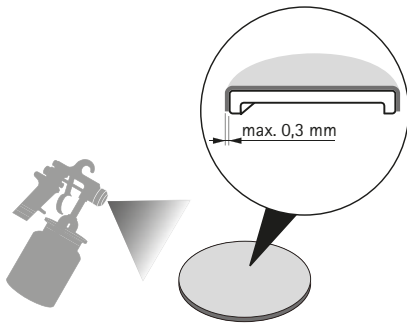

Dekorelemente für den Einsatz von Schichtstoff
Trim panels for applying laminate
Éléments pour la mise en œuvre de stratifié
Decoratief element voor het gebruik van eigen materiaal

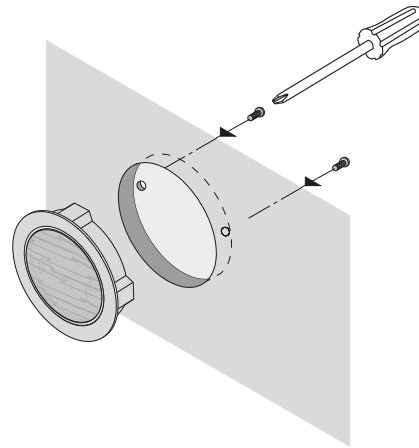
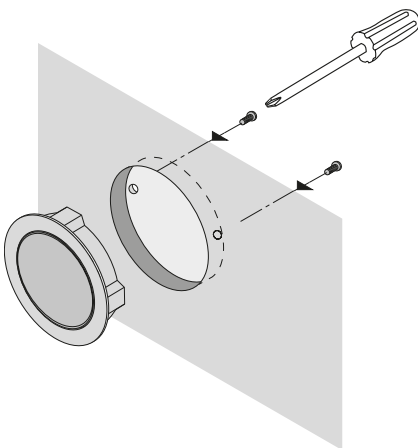
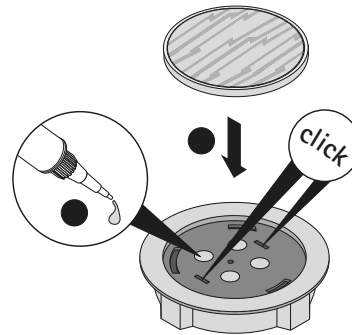
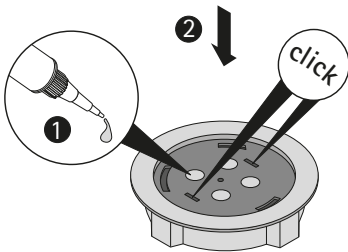
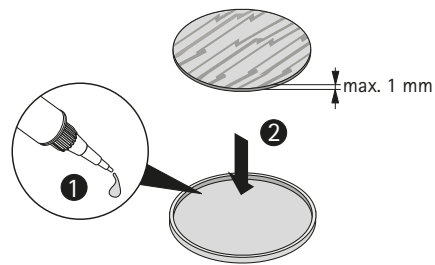

empfohlener Klebstoff: 2K SE Polymer, z. B. JOWAT 690.00
recommended adhesive: 2-comp. SE polymer, e.g. JOWAT 690.00
colle recommandée: polymère sylile époxy bicomposant, par exemple JOWAT 690.00
Aanbevolen lijm: 2K SE Polymer, b.v. JOWAT 690.00

Dekorelemente (ABS) zum Selbstlackieren
Trim panels (ABS) for laquer coating
Élément décoratif (ABS) à laquer soi-même
Decoratief element (ABS) om zelf te lakken

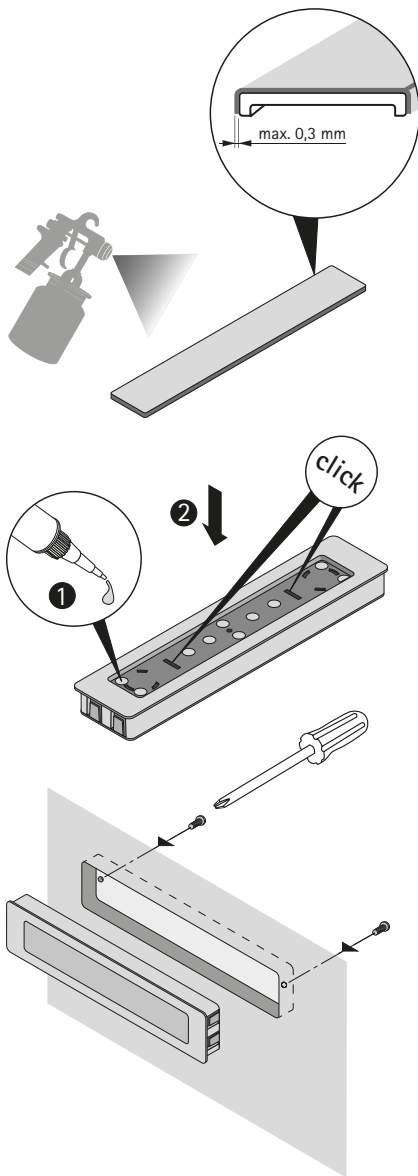

Dekorelemente für den Einsatz von Schichtstoff
Trim panels for applying laminate
Éléments pour la mise en œuvre de stratifié
Decoratief element voor het gebruik van eigen materiaal

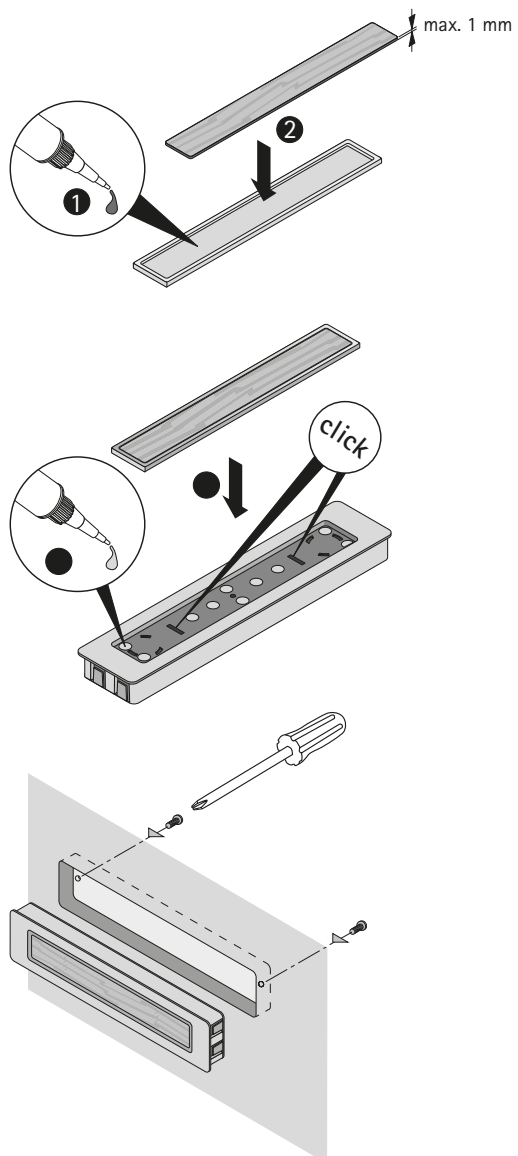

SERVICE

Hettich Service:
Kompetenz im Netz

Hettich Service:
Expertise on the web

Hettich Service:
la compétence sur Internet

Hettich service:
online competentie



Neue Möbelideen wirtschaftlich verwirklichen und das Bewährte stets verbessern!

Hettich unterstützt Sie online von der Ideenfindung über die konkrete Korpusplanung und Wahl der richtigen Beschläge bis hin zur effizienten Umsetzung.

Auf www.hettich.com finden Sie jede Menge Inspiration. Die passenden Beschläge dafür sind im Onlinekatalog mit erstem Produktüberblick bis zur Detailinformation schnell gefunden.

Für die exakte und einfache Planung mit Hettich Beschlägen stehen Ihnen die Korpusplanung mit HettichPlan, die Design Gallery mit konkreten Umsetzungslösungen sowie die Hettich CAD Beschlagbibliothek zur Verfügung. Der Hettich Technical Assistant hilft Ihnen bei der Montage und Einstellung der Hettich Produkte.

Realise new furniture ideas cost effectively and constantly improve the tried and tested!

Hettich assists you online with finding ideas, planning specific cabinet bodies, selecting the right fittings and efficient realisation.

You will find a wealth of inspiration at www.hettich.com. The right fittings are quickly found in the online catalogue with everything from an initial overview of products to detailed information.

You can use various tools for accurately and easily planning furniture with Hettich fittings: cabinet body planning with HettichPlan, the Design Gallery with specific solutions for realising furniture as well as the Hettich CAD fittings library. The Hettich Technical Assistant helps you with assembling and adjusting Hettich products.



Hettich App:

Unsere App erhalten Sie im jeweiligen Online Store

Hettich app:

Our app is available from the relevant online store

Appli Hettich :

Vous obtiendrez notre appli dans la boutique en ligne respective

Hettich app:

Onze app vindt u in de betreffende online store



Das gesamte Produktprogramm, weitere technische Details und zusätzlich benötigte Informationen finden sie im Hettich eShop.

You will find the entire product range, further technical details and any additional information you require in the Hettich eShop.

Vous trouverez toutes nos gammes de produits, de plus amples informations techniques et toutes les informations supplémentaires dont vous avez besoin dans le Hettich eShop.

Het volledige productassortiment, evenals technische en andere benodigde informatie vindt u in de Hettich eShop.



Pour réaliser de nouvelles idées de meubles de manière économique et pour améliorer constamment ce qui a déjà fait ses preuves !

Hettich vous apporte en ligne l'aide dont vous avez besoin non seulement pour trouver des idées, pour planifier concrètement un corps de meuble, pour choisir les ferrures adaptées, mais également pour réaliser l'ensemble de manière efficace.

Le site Internet www.hettich.com est une riche source d'inspiration. Vous trouverez rapidement les ferrures adaptées à tous vos projets de meubles dans le catalogue en ligne. Vous pourrez y consulter tout d'abord l'aperçu du produit puis toutes les informations détaillées le concernant.

Vous disposez de nombreux eTools astucieux pour concevoir facilement et avec précision vos meubles avec les ferrures Hettich : HettichPlan pour planifier le corps de meuble, la galerie des designs regroupant des solutions concrètes de mise en œuvre de nos produits ainsi que la bibliothèque de nos ferrures Hettich CAD.

Le Hettich Technical Assistant vous aide lors du montage et du réglage des produits Hettich.

Nieuwe meubelideeën op economische wijze omzetten en beproefde elementen continu verbeteren!

Hettich helpt u online bij het vinden van ideeën en de concrete kastplanning tot aan de keuze van het passende beslag en de efficiënte realisatie.

Op www.hettich.com vindt u een heleboel inspiratie. Het passende beslag hiervoor is snel gevonden in de online catalogus, van een eerste productoverzicht tot gedetailleerde informatie.

Voor de exacte en eenvoudige planning met Hettich beslag kan worden gekozen uit de kastplanning met Hettich Plan, de Design Gallery met concrete implementatie-oplossingen en de Hettich CAD beslagbibliotheek.

De Hettich Technical Assistant helpt u bij het monteren en instellen van de Hettich producten.

SERVICE

Befestigungsmaterial Fixing accessories Accessoires de fixation Bevestigingsmateriaal

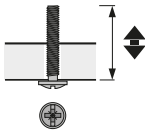

Griff-Befestigungsschrauben
mit Kreuz-Doppelschlit
Stahl verzinkt

Handle fixing screws cross-slotted
Galvanized steel

Vis de fixation de poignées
à fente cruciforme
Acier zingué

Greepbevestigingsschroeven
met dubbele kruisgleuf
Verzinkt staal

| l | | ☐ |
|----------|-----------|----|
| M 4 x 12 | 0 071 544 | 50 |
| M 4 x 14 | 0 071 545 | 50 |
| M 4 x 16 | 0 071 546 | 50 |
| M 4 x 18 | 0 071 547 | 50 |
| M 4 x 20 | 0 071 548 | 50 |
| M 4 x 22 | 0 071 549 | 50 |
| M 4 x 24 | 0 071 555 | 50 |
| M 4 x 26 | 0 071 556 | 50 |
| M 4 x 28 | 0 071 557 | 50 |

| l | | ☐ |
|----------|-----------|----|
| M 4 x 30 | 0 071 558 | 50 |
| M 4 x 32 | 0 071 559 | 50 |
| M 4 x 34 | 0 071 560 | 50 |
| M 4 x 36 | 0 071 561 | 50 |
| M 4 x 38 | 0 071 562 | 50 |
| M 4 x 40 | 0 071 563 | 50 |
| M 4 x 42 | 0 071 855 | 50 |
| M 4 x 45 | 0 071 856 | 50 |

Universal Griff-Befestigungsschraube
M4 x 45 mm mit Kreuz-Doppelschlit
kürzbar auf 40, 35, 30, 25 oder 20 mm
Stahl verzinkt

Universal handle cross-slotted fixing
screw M4 x 45 mm, can be shortened to
40, 35, 30, 25 or 20 mm
Galvanized steel

Vis universelle de fixation de poignée
M4 x 45 mm à fente cruciforme
réductible à 40, 35, 30, 25 ou 20 mm
Acier zingué

Universele greepbevestigingsschroef
M4 x 45 mm met dubbele kruisgleuf,
inkortbaar tot 40, 35, 30, 25 en 20 mm
Verzinkt staal



| | | |
|--|-----------|-----|
| | | ☐ |
| | 9 212 860 | 100 |



1 Aluminium Optik
Aluminium look
Aspect aluminium
Aluminiumkleurig

Befestigungssockel mit
M4 Gewinde für Ledergriffe
Gela und Galati
Zink



2 Verchromt glanz
Bright chrome plated
Chromé brillant
Glanzend verchromd

Attachment base with M4 thread
for leather handles
Gela and Galati
Zink



3 Vernickelt matt Optik
Matt nickel plated look
Aspect nickelé mat
Vernikkeld mat

Socle de fixation avec filetage M4 " "
pour poignée en cuir
Gela et Galati
Zink



4 Bronze Optik antik
Antique bronze look
Aspect bronze antique
Bronskleurig antiek

Bevestigingsvoet met M4
schroefdraad voor leren grepen
Gela en Galati
Zink

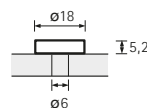

| | | ☐ |
|---|-----------|-----|
| 1 | 9 113 651 | 200 |
| 2 | 9 113 652 | 200 |
| 3 | 9 113 653 | 200 |
| 4 | 9 113 654 | 200 |

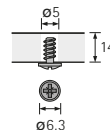

Spezialschraube für Ledergriff Nica
für Bohrung 5 mm
mit PZ-Kreuzschlit \varnothing 6,3 x 14 mm
Stahl verzinkt

Special screw for Nica leather handle
for 5 mm hole
with Pozidrive cross head \varnothing 6,3 x 14 mm
Galvanized steel

Vis spéciale pour poignée en cuir Nica
pour perçage 5 mm
avec empreinte cruciforme PZ \varnothing 6,3 x 14 mm
Acier zingué

Speciale schroef voor leren greep Nica
voor boring 5 mm
met PZ-kruisgleuf \varnothing 6,3 x 14 mm
Verzinkt staal

| | | |
|--|-----------|-----|
| | | ☐ |
| | 0 046 700 | 200 |

Distanzhülsen für Glastüren
Spacer sleeve for glass doors
Entretoise pour portes en verre
Afstandshuls voor glasdeuren



Distanzhülse zur Griffbefestigung an Glastüren
Kunststoff
Spacer sleeve for fixing handle to glass doors
Plastic
Entretoise pour vis de maintien pour portes en verre
Plastique
Afstandshuls voor greepbevestiging bij glazen deuren
Kunststof

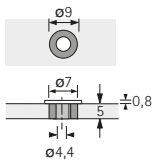

| | |
|-----------|-----|
| 9 113 347 | 100 |
|-----------|-----|

Adapter für Faltschiebetüren
Handle adaptor for folding/sliding doors
Adaptateur de poignée pour portes pliantes coulissantes
Greepadapter voor vouw-/schuifdeuren



1 Verchromt matt
Matt chrome plated
Chromé mat
Verchromd mat



2 Vernickelt matt
Matt nickel plated
Nickelé mat
Vernikkeld mat



Kunststoff-Unterlegscheibe
Plastic washer
Rondelle en plastique
Kunststof onderlegplaat

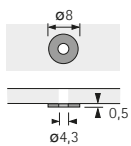

| | |
|-----------|------|
| 9 077 861 | 1000 |
|-----------|------|

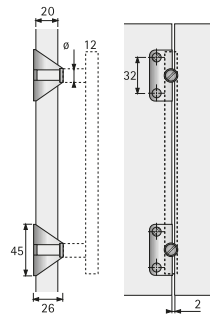

Einsetzbar für alle Grifflösungen bei einer maximalen Türdicke von 20 mm und einer Griff-Aufstandsfläche, mindestens $\varnothing 12$ mm.
Can be used for all handle solutions on door thicknesses of up to 20 mm and a handle mounting surface greater than 12 mm in diameter.

Applicable pour toutes les solutions de portes d'une épaisseur maximale de 20 mm et une surface de maintien de poignée plus grande que $\varnothing 12$ mm.

Geschikt voor alle greepoplossingen met een max. deurdikte van 20mm en een bevestigingsoppervlakte diameter van 12mm.

| | | |
|---|-----------|-----|
| 1 | 0 115 365 | 100 |
| 2 | 0 115 366 | 100 |

SERVICE

Accura-Bohrlehren
Accura drilling gauge
Matrices de perçage Accura
Accura-boormal

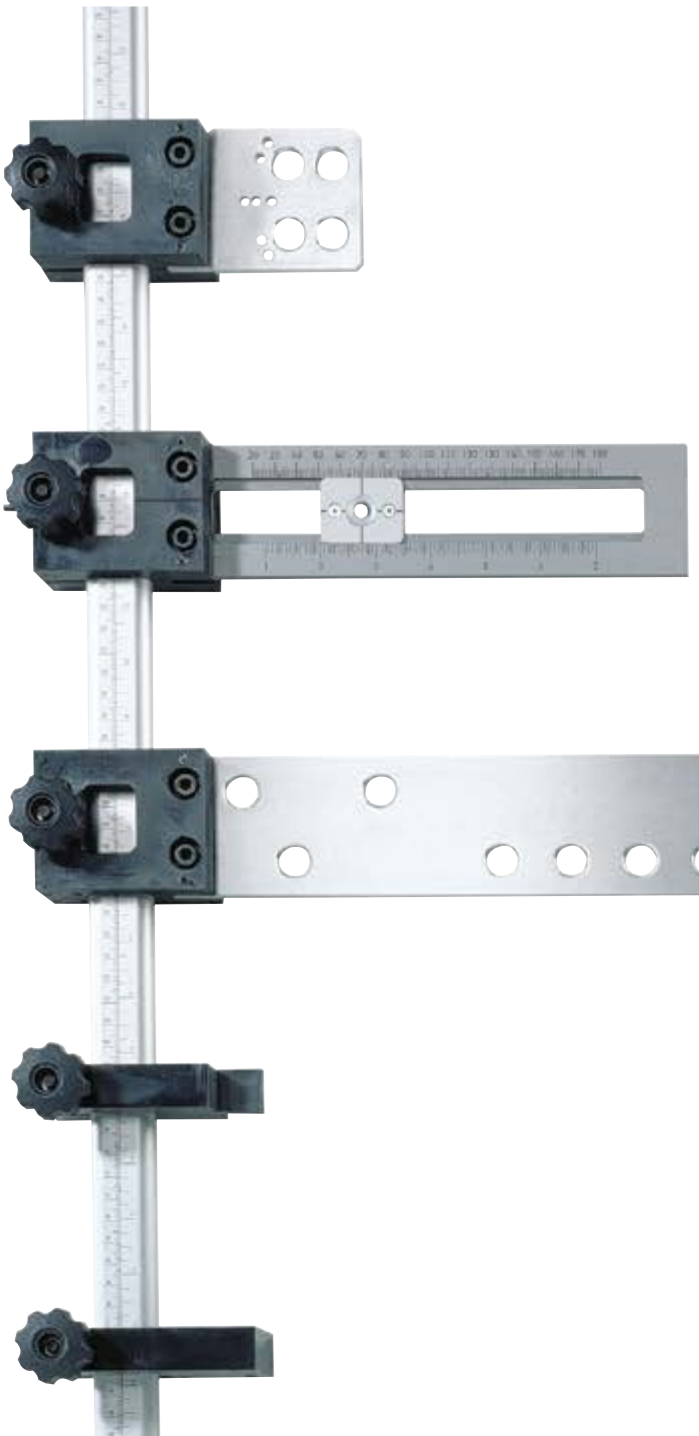

Accura – die rationelle, wirtschaftliche und fachgerechte Universal-Bohrlehre im Baukastensystem
 Accura - the practical and efficient universal modular drilling jig for perfect work results
 Accura - le gabarit universel, en système de construction par blocs, rationnel, économique et approprié
 Accura - de praktische en efficiënte modulaire boormal voor de vakman

Accura-Bohrkörper für Griffe
 Drilling jigs for handles
 La plaque Accura pour poignées
 Accura-boorlichaam voor grepen

Unterschiedliche Bohrkörper und Anschläge lassen sich auf der Accura-Schiene mit Mess-Skala in mm und Inch (Längen von 500 bis 2000 mm) beliebig positionieren.
 Different drilling templates and stops can be positioned anywhere on the Accura rail with metric and imperial measurement scale (lengths from 500 to 2000 mm).
 Différentes plaques de perçage et butées se laissent positionner au choix sur le gabarit Accura (longueur de 500 à 2000 mm) avec des graduations en mm et pouces.
 Verschillende boorlichamen en aanslagen laten zich op de Accura rail met meetschaal in mm en Inch (lengte van 500 tot 2000 mm) willekeurig positioneren.

Markierungen für Bohrungen im 32er Raster.
 Markings for drilling holes for the 32 mm hole spacing system.
 Marquage pour rangée de trous en système 32.
 Markering voor boringen in het systeem 32 raster.

Accura-Bohrkörper für Griffe
Accura drilling jigs for handles
La plaque Accura pour poignées
Accura-boorlichaam voor grepen

Accura-Bohrlehre, Set für Griffe besteht aus:

- 2 Accura-Bohrkörper für Griffe
 - 2 Bohrplatten mit Führungshülse für 5 mm-HSS-Spiralbohrer
 - 1 Accura-Schiene mit Maß-Skala in mm und Inch, Länge 500mm
 - 1 verstellbarer Anschlag für Fronten
- ② Accura-Schiene mit Mess-Skala in mm und Inch, mit Markierungspunkten „Raster 32“
- ┆ 500 mm
 - ┆ 1000 mm
 - ┆ 1500 mm
 - ┆ 2000 mm
- ③ Accura-Bohrkörper für Griffe, inkl. Bohrplatte mit Führungshülse für 5 mm-HSS-Spiralbohrer Aluminium/Kunststoff
- ④ Ersatzschieber mit Bohrbuchse für Accura-Bohrkörper für Griffe
- ⑤ Spiralbohrer 5 mm
- ⑥ Verstellbarer Anschlag für Fronten und einzelne (zerlegte) Korpusseiten, Kunststoff

Accura drilling gauge, kit for handles contains:

- 2 Accura drill templates for handles
 - 2 drill plates with guide sleeve for 5 mm high-powered high-speed steel twist drill
 - 1 Accura slide rail with measuring scale in mm and inch, Length 500mm
 - 1 adjustable stop for front edge alignment
- ② Accura rail with metric and imperial measuring scale, with "System 32" marking points
- ┆ 500 mm
 - ┆ 1000 mm
 - ┆ 1500 mm
 - ┆ 2000 mm
- ③ Accura drill template for handles, including drilling plate with guide sleeve for 5 mm HSS twist drill bits aluminium/plastic
- ④ Replacement slide rail with drilling bushes for Accura drilling templates for handles
- ⑤ 5 mm twist drill bit
- ⑥ Adjustable stop for fronts and individual (dismantled) cabinet sides, plastic

Gabarit de perçage Accura, kit pour poignées comprenant:

- 2 matrices de perçage Accura pour poignées
 - 2 plaques de perçage avec douille de guidage pour mèche à spirale à coupe rapide haute performance
 - 1 rail Accura avec graduation en mm et en pouces, Longueur 500mm
 - 1 butée réglable pour façades
- ② Rail Accura avec graduation en mm et en pouces, avec points de repérage système 32
- ┆ 500 mm
 - ┆ 1000 mm
 - ┆ 1500 mm
 - ┆ 2000 mm
- ③ Matrices de perçage Accura pour poignées, plaques de perçage avec douilles de guidage incl. pour mèche à spirale 5 mm aluminium/plastique
- ④ Coulisse de rechange avec douille de perçage pour matrices de perçage Accura pour poignées
- ⑤ Mèche à spirale 5 mm
- ⑥ Butée réglable pour façades et côtés de caisson (démontés), plastique

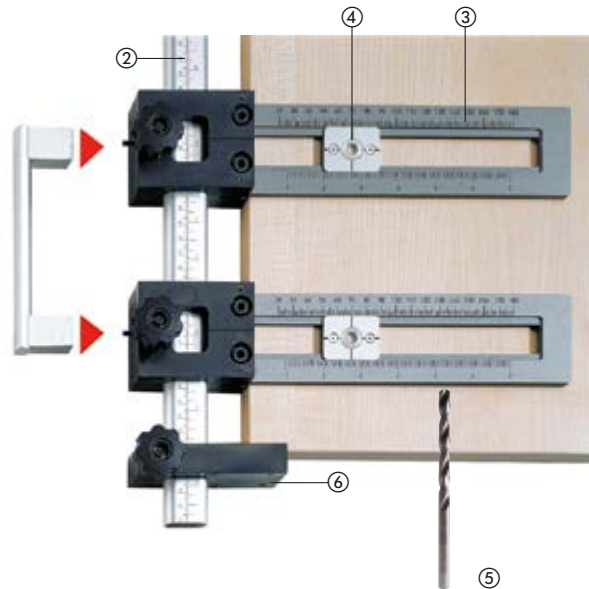

Accura-boormal, set voor grepen bestaat uit:

- 2 Accura-boorlichamen voor grepen
 - 2 Verstelbare boorhulzen voor 5mm HSS-spiraalboor
 - 1 Accura-rail 500 mm met maatverdeling in mm en inch
 - 1 instelbare aanslag voor frontplaten
- ② Accura-rail met maatverdeling in mm en inch, met markeringspunten voor "Systeem 32"
- ┆ 500 mm
 - ┆ 1000 mm
 - ┆ 1500 mm
 - ┆ 2000 mm
- ③ Accura-boorlichaam voor grepen, boorplaat met boorhuls voor 5 mm HSS-spiraalboor aluminium/kunststof
- ④ Vervang- en verstelbare boorhulzen voor Accura-boorlichaam
- ⑤ Spiraalboor 5 mm
- ⑥ Instelbare aanslag voor fronten en aparte (gedemonteerde) kastzijwanden uit kunststof

| | ┆ | □ |
|---|------|-------------|
| 2 | 500 | 0 044 763 1 |
| 2 | 1000 | 0 070 264 1 |
| 2 | 1500 | 0 070 264 1 |
| 2 | 2000 | 0 020 014 1 |
| 3 | | 0 044 765 1 |
| 4 | | 0 044 767 1 |
| 5 | | 0 044 766 1 |
| 6 | | 0 070 266 1 |

SERVICE

Accura-Bohrkörper für Griffe
Accura drilling jigs for handles
La plaque Accura pour poignées
Accura-boorlichaam voor grepen

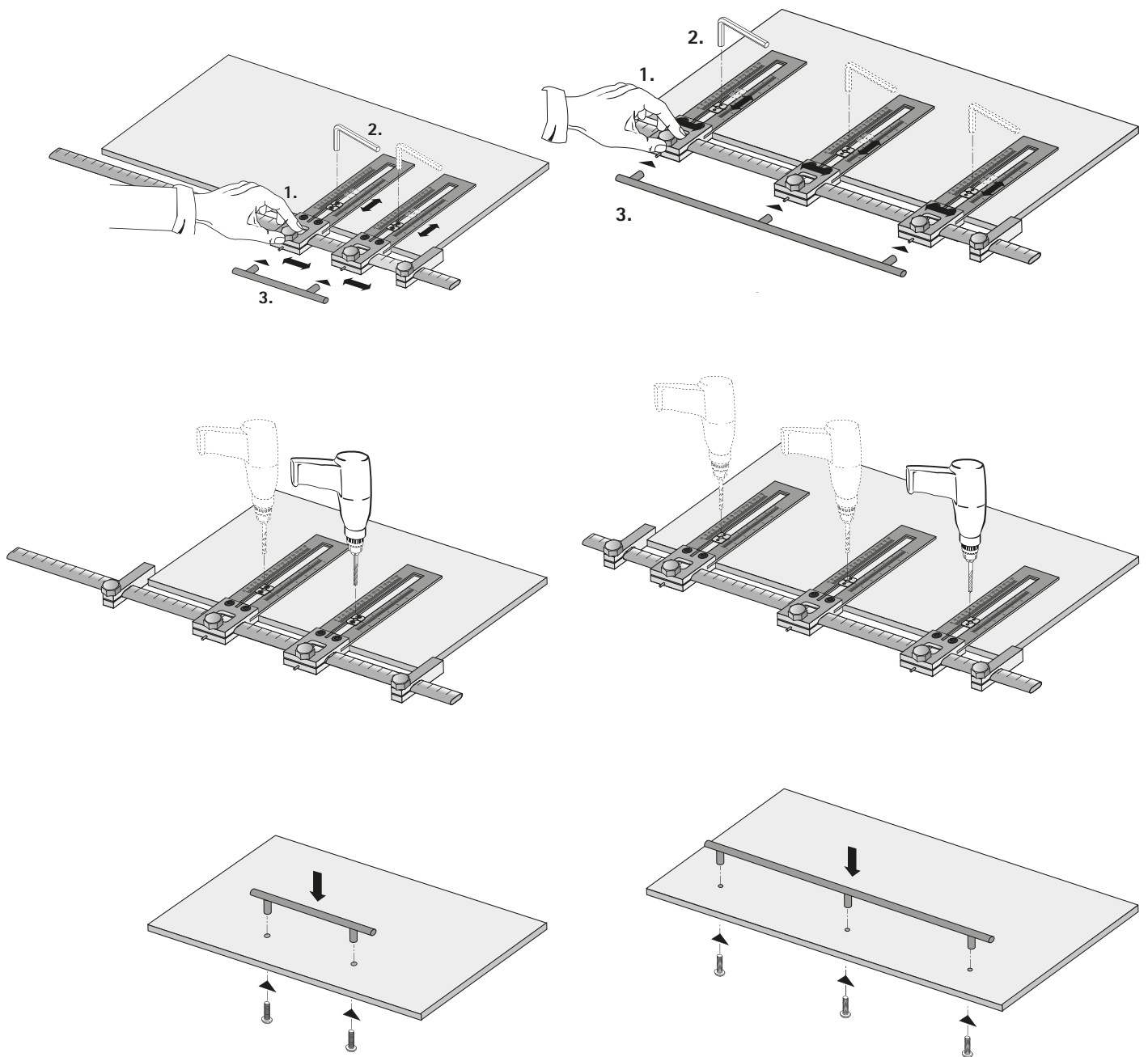

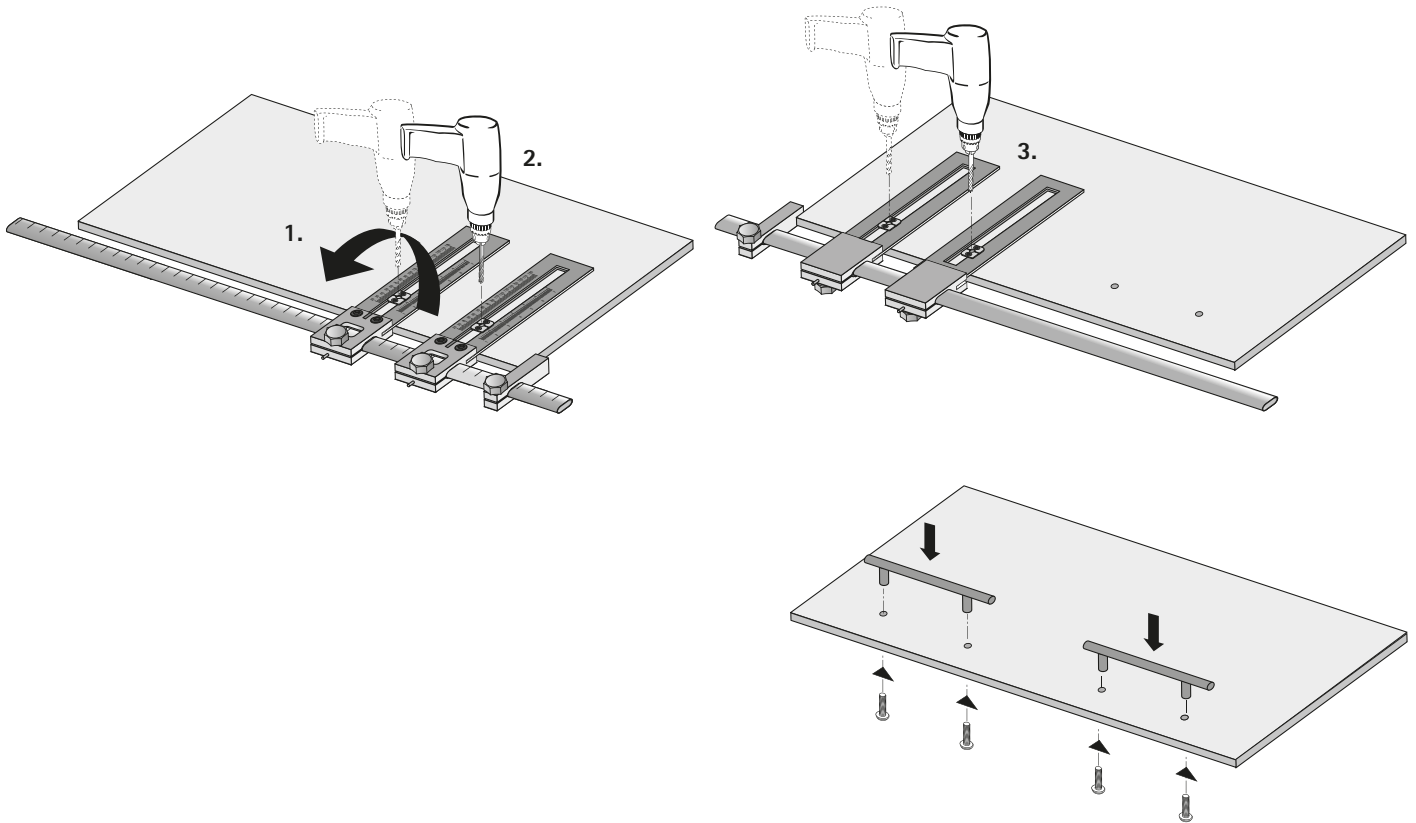

- Gewünschte Positionierung auf der Front einstellen
- Bohrabstand einstellen und über Abgreifelemente prüfen
- Bei einem Griff mit 2 oder 3 Sockeln: Eingestellte Bohrlehre auflegen und bohren
- Griff anschrauben

- Set chosen positioning on the front
- Set hole spacing and check using Handle fixing points
- For a handle with 2 or 3 stremes: Place drilling jig on front and drill
- Screw on handle

- Régler la position souhaitée sur la façade
- Régler la distance de perçage et vérifier à l'aide des éléments ajustables
- Dans le cas d'une poignée centrée avec 2 ou 3 socles sur une façade: poser le gabarit de perçage réglé et percer
- Visser la poignée

- Gewenste positionering op op het front instellen
- Boorafstand instellen en m.b.t. meetelementen controleren
- Bij een greep met 2 of 3 sokkels: ingestelde boormal opleggen en boren
- Greep aanschroeven

Bei zwei symmetrisch positionierten Griffen: Bohrlehre zunächst an einer Seite anlegen um für den 1. Griff zu bohren, danach ohne Umstellung der Bohrlehre an der anderen Seite anlegen um für den 2. Griff zu bohren.

For two symmetrically positioned handles: First position drilling jig on one side to drill the holes for the 1st handle and then, without altering the setting, position drilling jig on the other side to drill the holes for the 2nd handle.

Dans le cas de 2 poignées placées symétriquement sur une façade: poser d'abord le gabarit de perçage d'un côté pour percer la 1^{ère} poignée, puis sans changer de gabarit de perçage, poser sur l'autre côté pour percer la 2^{ème} poignée.

Bij twee symmetrisch gepositioneerde grepen: De Accura boormal eerst aan één kant aanleggen, voor de 1ste greep te boren, dan zonder om te stellen de Accura boormal aan de andere kant aanleggen om de 2de greep te boren.

SERVICE

Universal-Ankörnlehre für Griffe und Knöpfe
Universal hole marking template for handles and knobs
Gabarit de centrage pour poignées et boutons
Universele centreermal voor grepen en knoppen

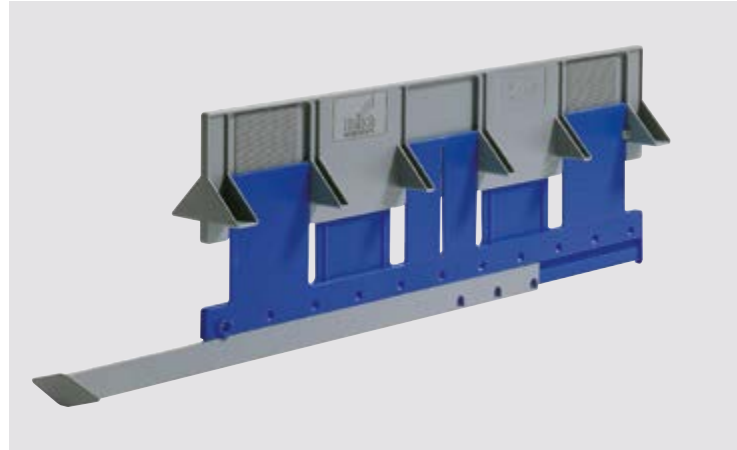

Zweidimensional einstellbare Ankörnlehre zur schnellen und präzisen Markierung der Bohrpositionen im System 32 für

- Griffe (Bohrabstand von 32-320 mm)
- Knöpfe

Einstellbereiche:

- Abstand Blendenseitenkante bis zur ersten Befestigungsbohrung des Griffes 10-334 mm
- Abstand Blendenober-/Blendenunterkante bis zur Griffposition 20-65 mm

Adjustable, two-dimensional hole marking template for fast, accurate marking of System 32 hole patterns for

- Handles (Hole spacing of 32-320 mm)
- Knobs

Range of adjustment:

- Distance from drawer front side edge to first fixing hole of handle 10 - 334 mm
- Distance from drawer front top/bottom edge to position of handle 20 - 65 mm

Gabarit de centrage réglable sur 2 dimensions pour un marquage rapide et précis des positions de perçage en système 32 pour

- Poignées (distance de perçage de 32-320 mm)
- Boutons

Plage de réglage :

- Distance du chant latéral de bandeau au perçage de fixation de la poignée 10-334 mm
- Distance chant supérieur/inférieur de bandeau à la position de poignée 20-65 mm

Tweedimensioneel afstelbare centreermal voor de snelle en precieze markering van de boorposities in het Systeem 32 voor

- Grepen (booraafstand van 32-320 mm)
- Knoppen

Afstelbereiken:

- Afstand zijkant van de frontplaat tot de eerste bevestigingsbooring van de greep 10-334 mm
- Afstand boven-/onderkant van de frontplaat tot de greeppositie 20-65 mm

0 048 771 1

Einstellung Höhen-Positionierung
 Setting for height positioning
 Réglage positionnement en hauteur
 Instelling hoogtepositionering

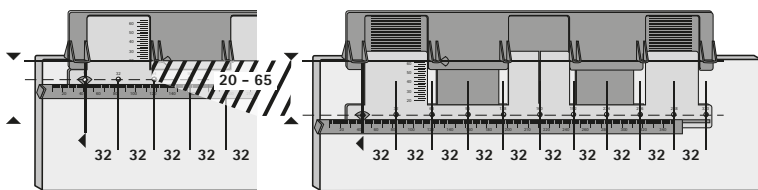

Berechnungsformeln
Calculations formulae
Formules de calcul
Berekeningsformules

Seiten-Positionierung für einen Griff
Side positioning for a handle
Positionnement latéral pour une poignée
Zijdelingse positionering voor een greep

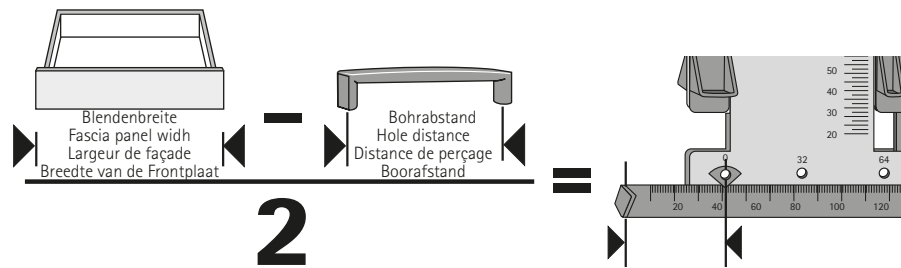

Abstand Blendenseitenkante bis zur ersten Befestigungsbohrung des Griffes (min. 10 mm / max. 334 mm)
Distance from drawer front side edge to first fixing hole of handle (min. 10 mm / max. 334 mm)

Distance du chant latéral de bandeau au perçage de fixation de la poignée (min. 10 mm / max. 334 mm)
Afstand zijkant van het front tot de eerste bevestigingsboring van de greep (min. 10 mm / max. 334 mm)

Seiten-Positionierung für einen Knopf
Side positioning for a knob
Positionnement latéral pour un bouton
Zijdelingse positionering voor een knop

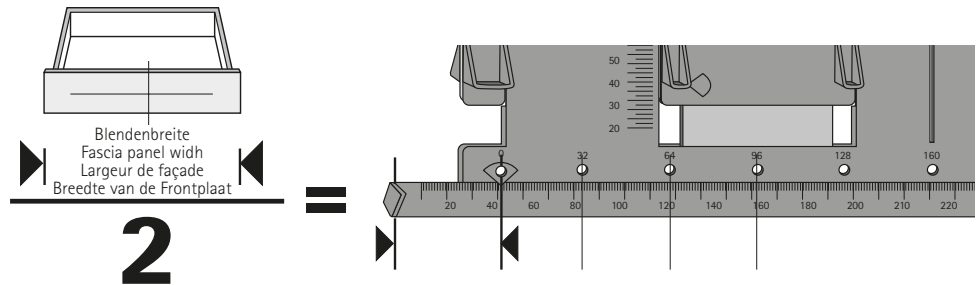

Abstand Blendenseitenkante bis zur Befestigungsbohrung des Knopfes (min. 10 mm / max. 334 mm)
Distance from drawer front side edge to knob fixing hole (min. 10 mm / max. 334 mm)

Distance du chant latéral de bandeau au perçage de fixation du bouton (min. 10 mm / max. 334 mm)
Afstand zijkant van het front tot de bevestigingsboring van de knop (min. 10 mm / max. 334 mm)

Einstellung Seiten-Positionierung
Setting for side positioning
Réglage positionnement latéral
Instelling zijdelingse positionering

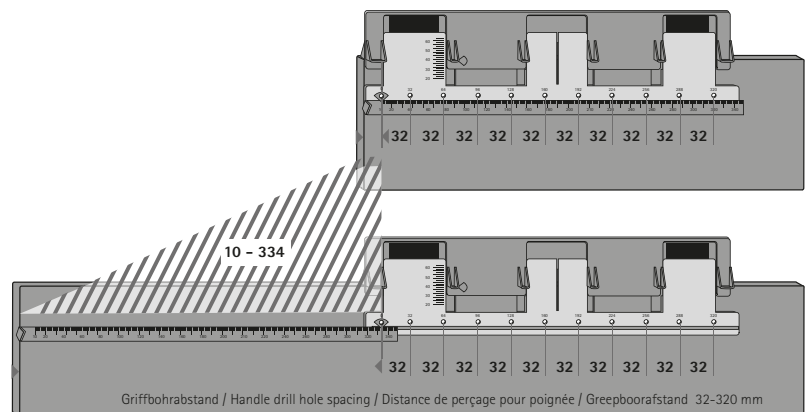

SERVICE



Universal-Ankörnlehre für Griffe und Knöpfe
Universal hole marking template for handles and knobs
Gabarit de centrage pour poignées et boutons
Universele centreermal voor grepen en knoppen

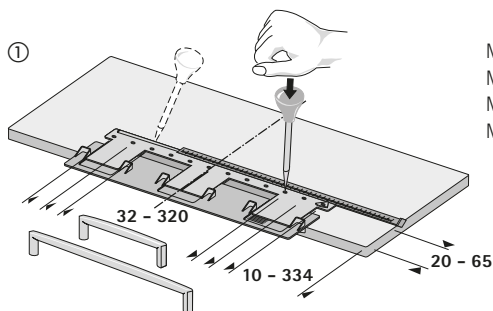

Montage – ein Griff
 Mounting – one handle
 Montage – une poignée
 Montage – één greep

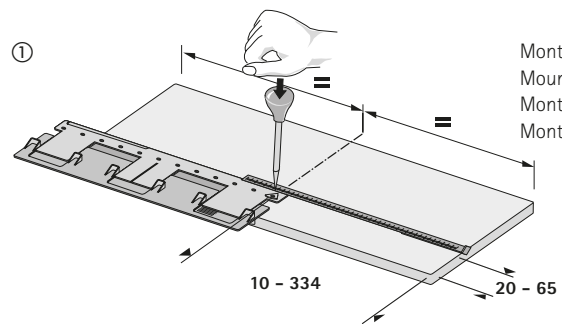

Montage – ein Knopf
 Mounting – one knob
 Montage – un bouton
 Montage – één knop

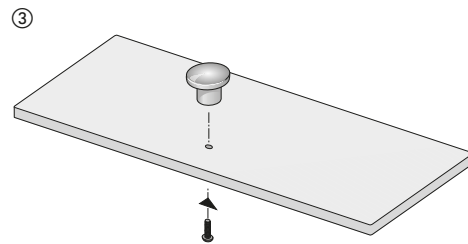
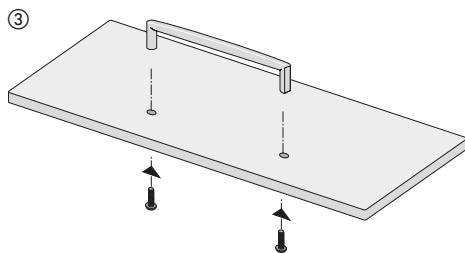
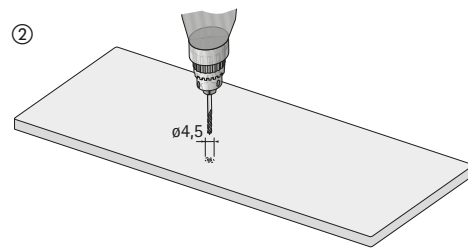
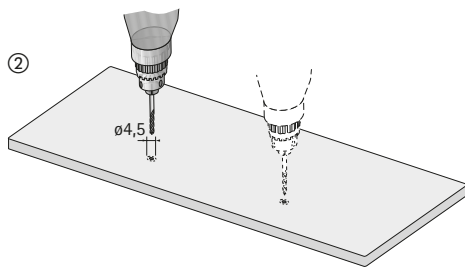

- ① Bohrlehre einstellen und Bohrpositionen ankörnen
- ① Set drilling jig and mark drill hole positions
- ① Régler le gabarit de perçage et centrer les positions de perçage
- ① Boormal afstellen en boorposities centreren

- ② Befestigungslöcher bohren
- ② Drill fixing holes
- ② Percer les trous de fixation
- ② Bevestigingsgaten boren

- ③ Griff anschrauben
- ③ Screw on handle
- ③ Visser la poignée
- ③ Greep aanschroeven

Für die exakte Übertragung der Bohrpositionen von rechts nach links kann die Universal-Ankörnlehre einfach umgekehrt angelegt werden.
 The universal hole marking template can simply be used the other way round for accurately transferring hole patterns from right to left.

- ① Bohrlehre einstellen und Bohrpositionen ankörnen
- ① Set drilling jig and mark drill hole positions
- ① Régler le gabarit de perçage et centrer les positions de perçage
- ① Boormal afstellen en boorposities centreren

- ② Befestigungslöcher bohren
- ② Drill fixing holes
- ② Percer les trous de fixation
- ② Bevestigingsgaten boren

- ③ Knopf anschrauben
- ③ Screw on knob
- ③ Visser le bouton
- ③ Knop aanschroeven

Pour le report exact des positions de perçage de la droite vers la gauche, il est possible de poser simplement le gabarit de centrage universel sur l'autre face.
 Voor de precieze overbrenging van de boorposities van rechts naar links kan de universele centreermal gewoonweg omgekeerd worden aangelegd.

Montage – zwei Griffe (symmetrisch positioniert)
 Mounting – two handles (positioned symmetrically)
 Montage – deux poignées (positionnement symétrique)
 Montage – twee grepen (symmetrisch gepositioneerd)

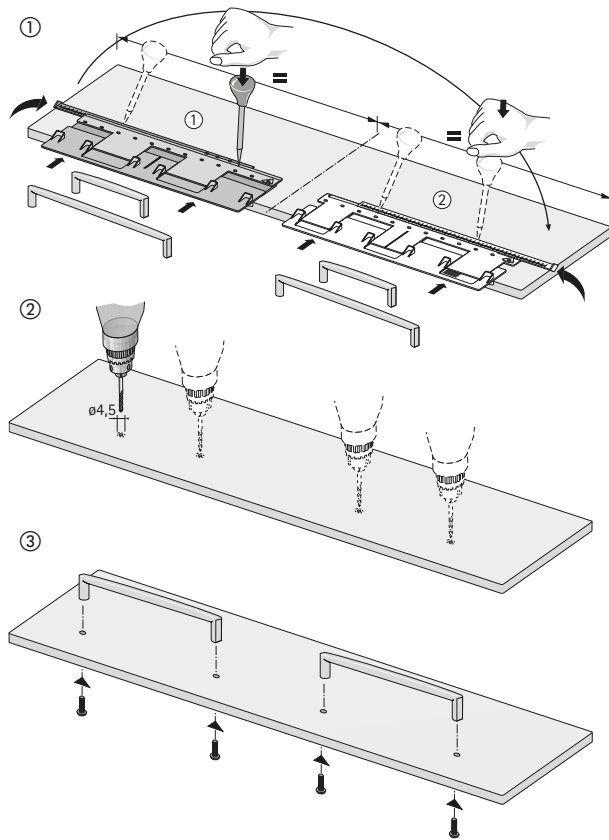

- ① Bohrlehre einstellen und Bohrpositionen ankönnen
- ① Set drilling jig and mark drill hole positions
- ① Régler le gabarit de perçage et centrer les positions de perçage
- ① Boormal afstellen en boorposities centreren
- ② Befestigungslöcher bohren
- ② Drill fixing holes
- ② Percer les trous de fixation
- ② Bevestigingsgaten boren
- ③ Griff anschrauben
- ③ Screw on handle
- ③ Visser la poignée
- ③ Greep aanschroeven

Für die exakte Übertragung der Bohrpositionen von rechts nach links kann die Universal-Ankönnlehre einfach umgekehrt angelegt werden.
 The universal hole marking template can simply be used the other way round for accurately transferring hole patterns from right to left.

Montage – zwei Knöpfe (symmetrisch positioniert)
 Mounting – two knobs (positioned symmetrically)
 Montage – deux boutons (positionnement symétrique)
 Montage – twee knoppen (symmetrisch gepositioneerd)

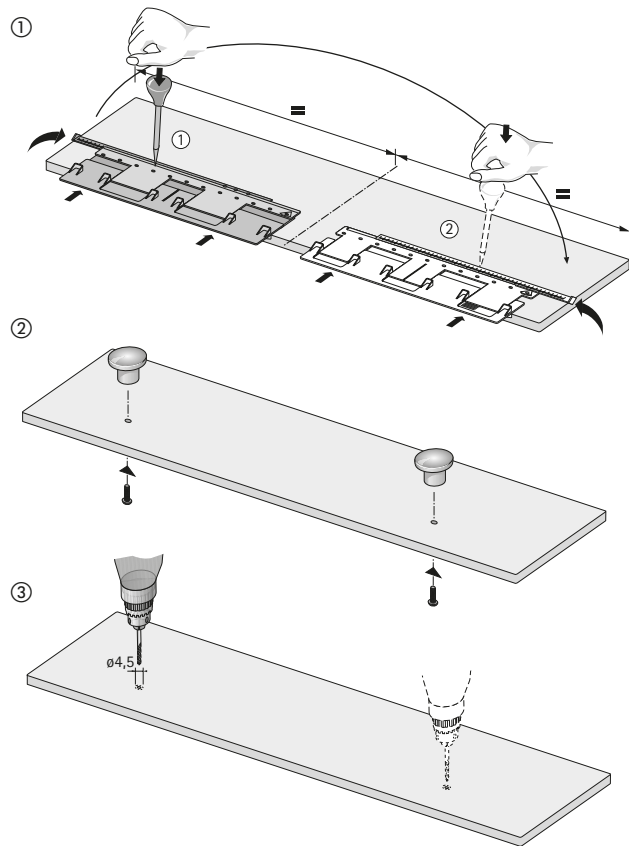

- ① Bohrlehre einstellen und Bohrpositionen ankönnen
- ① Set drilling jig and mark drill hole positions
- ① Régler le gabarit de perçage et centrer les positions de perçage
- ① Boormal afstellen en boorposities centreren
- ② Befestigungslöcher bohren
- ② Drill fixing holes
- ② Percer les trous de fixation
- ② Bevestigingsgaten boren
- ③ Knopf anschrauben
- ③ Screw on knob
- ③ Visser le bouton
- ③ Knop aanschroeven

Pour le report exact des positions de perçage de la droite vers la gauche, il est possible de poser simplement le gabarit de centrage universel sur l'autre face.
 Voor de precieze overbrenging van de boorposities van rechts naar links kan de universele centreermal gewoonweg omgekeerd worden aangelegd.

INDEX

Programmübersicht sortiert nach Materialien
Product-line overview arranged by materials
Aperçu du programme trié par matériaux
Programma overzicht gesorteerd naar materiaal

Stahl
Steel
Acier
Staal



17 Hale



63 Nicia



70 Avenio



90 Valentia

Stahl und Zink
Steel and Zinc
Acier et Zinc
Staal en zink



37 Misnia



90 Malaca

Zink
Zinc
Zinc
Zinc



6 Vigilia



9 Evisa



10 Zenga



11 Nursia



12 Cheam



12 Tornea



16 Alvito



19 Fermo



26 Celistà



26 Genoa



27 Rialto



27 Messina



28 Milo



28 Venusia



35 Genzone



38 Novae



42 Amisia



42 Limpio



43 Istrana



43 Itri



44 Forli



45 Utinum



46 Buena



47 Baldone



47 Belluno



49 Intra



50 Veronia



50 Basilia



51 Arimini



51 Opera



51 Saturnia



52 Delia



52 Lodi



52 Sava



53 Solda



53 Londa



54 Fogo



54 Bona



58 Neapolis



58 Tolfo



58 Athena



59 Olivia



60 Felina



61 Coria



61 Parma



62 Balmo



62 Carvo



64 Bathia



64 Matilo



65 Salona



65 Ovada



66 Fectio



66 Vantania



67 Tolosa



67 Dinia



71 Belna



72 Lucca



73 Chalcis



73 Vieste



74 Suasa



74 Carolina



75 Trento



75 Meana



77 Tardiano



77 Ladera



77 Issa



78 Sala



78 Almus



79 Cirpi



79 Murcia



82 Cato



82 Calili



83 Ponzone



83 Ponti



84 Corduba



84 Vesontio



84 Ponoka



84 Oka



85 Luro



85 Tarraco

INDEX

Programmübersicht sortiert nach Materialien
 Product-line overview arranged by materials
 Aperçu du programme trié par matériaux
 Programma overzicht gesorteerd naar materiaal



85 Pomezia



85 Potovio



86 Barcino



86 Bracara



86 Olisipo



87 Arezzo



87 Topeka



88 Siradia



88 Sertao



89 Haida



89 Terranda



89 Gissi



89 Osimo



91 Egara



91 Bruxella



92 Salacia



92 Eburaco



92 Savelli



92 Salemi



93 Alberta



94 Meduno



94 Flavia



94 Emo



95 Bevipo



95 Dipo



100 Lorica



100 Matane



101 Essa



101 Tonala



102 Galleno



102 Fossa



102 Solva



103 Altedo



103 Larru

Aluminium
 Aluminium
 Aluminium
 Aluminium



7 Apua



7 Nubia



8 Torino



8 Velitra



9 Capua



9 Imperia



15 Clivia



19 Kervo



20 Stabia



21 Rovigo



22/23 Canis L



24/25 Canis C



29 Trani



29 Ticinum



31 Lamezia



32 Lindavia



32 Lutetia



32 Eslinga



32 Seveso



33 Mosena



34 Riaza



68 Naila



68 Culmen



72 Catana



76 Codania



93 Ogulin

**Aluminium und Zink
Aluminium and Zinc
Aluminium et Zinc
Aluminium en zink**



11 Bermeo



35 Capris



36 Nidum



36 Spira



59 Borgoa

**Edelstahl
Stainless steel
Acier inoxydable
Roestvrij staal**



6 Tempe



13 Anzio



13 Arnum



14 Aratti



14 Aosta



16 Pola



16 Guarani



16 Narona



18 Salvia



30 Narni



37 Apolda



38 Onex



38 Agrinum



38 Monacum



39 Danum



39 Sion



39 Spalatum

INDEX

Programmübersicht sortiert nach Materialien
Product-line overview arranged by materials
Aperçu du programme trié par matériaux
Programma overzicht gesorteerd naar materiaal



48 Ponte



60 Aboa



69 Vada



71 Asopus



77 Sipontum



79 Serbinum



100 Dodona

Messing
Brass
Laiton
Messing



30 Empoli

Edelstahl und Zink
Stainless steel and Zinc
Acier inoxydable et Zinc
Roestvrij staal en zink



44 Brema



45 Como

Stahl und Edelstahl
Steel and Stainless steel
Acier et Acier inoxydable
Staal en roestvrij staal



48 Cecina

Zink und Kunststoff
Zinc and plastic
Zinc et Plastique
Zink en kunststof



105 Touch-in



105 Touch-in

Leder
Leather
Cuir
Leer



97 Gela



97 Galati



98 Nica

Leder und Stahl
Leather and Steel
Cuir et Acier
Leer en staal



96 Byzantia

Leder und Messing
Leather and Brass
Cuir et Laiton
Leer en messing



98 Filaga

Leder und Zink
Leather and Zinc
Cuir et Zinc
Leer en zink



99 Agna



99 Agliano



99 Dublina

Leder und Edelstahl
Leather and Stainless steel
Cuir et Acier inoxydable
Leer en roestvrij staal



96 Getafe

Leder, Holz und Zink
Leather, Wood and Zinc
Cuir, Bois et Zinc
Leer, hout en zink



99 Arago

Sachwortverzeichnis
 Product Index
 Index
 Trefwoordregister

| | | | | | | | |
|----------|-------|----------|-----|----------|-----|----------|-----|
| Aboa | 60 | Como | 45 | Matane | 100 | Solda | 53 |
| Agliano | 99 | Corduba | 84 | Matilo | 64 | Solva | 102 |
| Agna | 99 | Coria | 61 | Meana | 75 | Spalatum | 39 |
| Agrinum | 38 | Culmen | 68 | Meduno | 94 | Spira | 36 |
| Alberta | 93 | Danum | 39 | Messana | 27 | Stabia | 20 |
| Almus | 78 | Delia | 52 | Milo | 28 | Suasa | 74 |
| Altedo | 103 | Dinia | 67 | Misnia | 37 | Tardiano | 77 |
| Alvito | 16 | Dipo | 95 | Monacum | 38 | Tarraco | 85 |
| Amisia | 42 | Dodona | 100 | Mosena | 33 | Tempe | 6 |
| Anzio | 13 | Dublina | 99 | Murcia | 79 | Terranda | 89 |
| Aosta | 14 | Eburaco | 92 | Naila | 68 | Ticinum | 29 |
| Apolda | 37 | Egara | 91 | Narni | 30 | Tolfo | 58 |
| Apua | 7 | Emo | 94 | Narona | 16 | Tolosa | 67 |
| Arago | 99 | Empoli | 30 | Neapolis | 58 | Tonala | 101 |
| Aratti | 14 | Eslinga | 32 | Nica | 98 | Topeka | 87 |
| Arezzo | 87 | Essa | 101 | Nicia | 63 | Torino | 8 |
| Arimini | 51 | Evisa | 9 | Nidum | 36 | Tornea | 12 |
| Arnum | 13 | Fectio | 66 | Novae | 38 | Touch-in | 105 |
| Asopus | 71 | Felina | 60 | Nubia | 7 | Trani | 29 |
| Athens | 58 | Fermo | 19 | Nursia | 11 | Trento | 75 |
| Avenio | 70 | Filaga | 98 | Ogulin | 93 | Utinum | 45 |
| Baldone | 47 | Flavia | 94 | Oka | 84 | Vada | 69 |
| Balmo | 62 | Fogo | 54 | Olisipo | 86 | Valentia | 90 |
| Barcino | 86 | Forli | 44 | Olivia | 59 | Vantania | 66 |
| Basilia | 50 | Fossa | 102 | Onex | 38 | Velitra | 8 |
| Bathia | 64 | Galati | 97 | Opera | 51 | Venusia | 28 |
| Belluno | 47 | Galleno | 102 | Osimo | 89 | Veronia | 50 |
| Belna | 71 | Gela | 97 | Ovada | 65 | Vesontio | 84 |
| Bermeo | 11 | Genoa | 26 | Parma | 61 | Vieste | 73 |
| Bevipo | 95 | Genzone | 35 | Pola | 16 | Vigilia | 6 |
| Bona | 54 | Getafe | 96 | Pomezia | 85 | Zenga | 10 |
| Borgoa | 59 | Gissi | 89 | Ponoka | 84 | | |
| Bracara | 86 | Guarani | 16 | Ponte | 48 | | |
| Brema | 44 | Haida | 89 | Ponti | 83 | | |
| Bruxella | 91 | Hale | 17 | Ponzone | 83 | | |
| Buena | 46 | Imperia | 9 | Potovio | 85 | | |
| Byzantia | 96 | Intra | 49 | Rialto | 27 | | |
| Calili | 82 | Issa | 77 | Riaza | 34 | | |
| Canis C | 24/25 | Istrana | 43 | Rovigo | 21 | | |
| Canis L | 22/23 | Itri | 43 | Sala | 78 | | |
| Capris | 35 | Kervo | 19 | Salacia | 92 | | |
| Capua | 9 | Ladera | 77 | Salemi | 92 | | |
| Carolina | 74 | Lamezia | 31 | Salona | 65 | | |
| Carvo | 62 | Larru | 103 | Salvia | 18 | | |
| Catana | 72 | Limpio | 42 | Saturnia | 51 | | |
| Cato | 82 | Lindavia | 32 | Sava | 52 | | |
| Cecina | 48 | Lodi | 52 | Savelli | 92 | | |
| Celista | 26 | Londa | 53 | Serbinum | 79 | | |
| Chalcis | 73 | Lorica | 100 | Sertao | 88 | | |
| Cheam | 12 | Lucca | 72 | Seveso | 32 | | |
| Cirpi | 79 | Luro | 85 | Sion | 39 | | |
| Clivia | 15 | Lutetia | 32 | Sipontum | 77 | | |
| Codania | 76 | Malaca | 90 | Siradia | 88 | | |

INDEX

Bestellnummernverzeichnis

Order Number Index

Index des références de commande

Overzicht bestelnummers

| | | | | | | | | | |
|-----------|-----|-----------|----|-----------|-----|-----------|----|-----------|-----|
| 0 020 014 | 115 | 0 115 081 | 72 | 0 115 360 | 15 | 9 069 909 | 70 | 9 070 448 | 70 |
| 0 043 472 | 62 | 0 115 090 | 32 | 0 115 361 | 15 | 9 069 915 | 70 | 9 070 451 | 69 |
| 0 043 502 | 47 | 0 115 091 | 32 | 0 115 362 | 15 | 9 069 919 | 70 | 9 070 457 | 69 |
| 0 043 503 | 47 | 0 115 115 | 32 | 0 115 363 | 15 | 9 069 922 | 70 | 9 070 466 | 69 |
| 0 043 505 | 47 | 0 115 122 | 58 | 0 115 364 | 15 | 9 069 927 | 70 | 9 070 481 | 69 |
| 0 043 506 | 47 | 0 115 127 | 37 | 0 115 365 | 113 | 9 069 942 | 71 | 9 070 492 | 64 |
| 0 043 642 | 47 | 0 115 146 | 68 | 0 115 366 | 113 | 9 069 943 | 70 | 9 070 493 | 64 |
| 0 043 643 | 47 | 0 115 147 | 68 | 0 115 374 | 86 | 9 070 025 | 70 | 9 070 494 | 69 |
| 0 044 763 | 115 | 0 115 148 | 68 | 0 115 385 | 48 | 9 070 030 | 70 | 9 070 501 | 69 |
| 0 044 764 | 115 | 0 115 149 | 68 | 0 115 387 | 48 | 9 070 054 | 70 | 9 070 504 | 69 |
| 0 044 765 | 115 | 0 115 150 | 68 | 1 160 018 | 13 | 9 070 075 | 70 | 9 070 508 | 64 |
| 0 044 766 | 115 | 0 115 152 | 68 | 1 160 019 | 13 | 9 070 078 | 70 | 9 070 509 | 69 |
| 0 044 767 | 115 | 0 115 153 | 68 | 1 160 020 | 13 | 9 070 095 | 75 | 9 070 510 | 90 |
| 0 046 700 | 112 | 0 115 154 | 28 | 1 160 021 | 13 | 9 070 096 | 71 | 9 070 511 | 70 |
| 0 048 771 | 118 | 0 115 155 | 28 | 1 160 022 | 13 | 9 070 101 | 71 | 9 070 512 | 70 |
| 0 070 263 | 115 | 0 115 156 | 27 | 1 160 023 | 13 | 9 070 102 | 71 | 9 070 513 | 90 |
| 0 070 264 | 115 | 0 115 157 | 27 | 1 160 024 | 13 | 9 070 103 | 71 | 9 070 516 | 64 |
| 0 070 266 | 115 | 0 115 169 | 71 | 1 160 025 | 13 | 9 070 104 | 44 | 9 070 519 | 70 |
| 0 071 544 | 112 | 0 115 170 | 71 | 1 170 155 | 65 | 9 070 105 | 71 | 9 070 520 | 54 |
| 0 071 545 | 112 | 0 115 181 | 37 | 1 170 158 | 66 | 9 070 106 | 44 | 9 070 521 | 70 |
| 0 071 546 | 112 | 0 115 182 | 37 | 1 170 173 | 94 | 9 070 107 | 44 | 9 070 522 | 70 |
| 0 071 547 | 112 | 0 115 183 | 37 | 9 064 670 | 9 | 9 070 108 | 44 | 9 070 523 | 54 |
| 0 071 548 | 112 | 0 115 195 | 64 | 9 064 671 | 9 | 9 070 109 | 44 | 9 070 527 | 70 |
| 0 071 549 | 112 | 0 115 203 | 67 | 9 064 819 | 7 | 9 070 110 | 44 | 9 070 540 | 70 |
| 0 071 555 | 112 | 0 115 205 | 15 | 9 064 820 | 7 | 9 070 111 | 71 | 9 070 548 | 70 |
| 0 071 556 | 112 | 0 115 206 | 15 | 9 065 425 | 58 | 9 070 112 | 44 | 9 070 552 | 70 |
| 0 071 557 | 112 | 0 115 207 | 15 | 9 065 426 | 58 | 9 070 113 | 44 | 9 070 556 | 59 |
| 0 071 558 | 112 | 0 115 208 | 15 | 9 065 427 | 58 | 9 070 117 | 71 | 9 070 557 | 70 |
| 0 071 559 | 112 | 0 115 209 | 15 | 9 065 611 | 26 | 9 070 118 | 71 | 9 070 562 | 79 |
| 0 071 560 | 112 | 0 115 210 | 15 | 9 065 612 | 26 | 9 070 119 | 71 | 9 070 565 | 59 |
| 0 071 561 | 112 | 0 115 211 | 15 | 9 065 627 | 6 | 9 070 120 | 71 | 9 070 567 | 59 |
| 0 071 562 | 112 | 0 115 212 | 15 | 9 065 628 | 6 | 9 070 121 | 75 | 9 070 568 | 77 |
| 0 071 563 | 112 | 0 115 213 | 15 | 9 065 634 | 50 | 9 070 122 | 71 | 9 070 572 | 70 |
| 0 071 855 | 112 | 0 115 214 | 15 | 9 065 635 | 50 | 9 070 123 | 75 | 9 070 574 | 59 |
| 0 071 856 | 112 | 0 115 215 | 15 | 9 069 804 | 14 | 9 070 124 | 71 | 9 070 575 | 102 |
| 0 074 134 | 62 | 0 115 216 | 15 | 9 069 805 | 14 | 9 070 125 | 75 | 9 070 577 | 70 |
| 0 115 014 | 8 | 0 115 217 | 15 | 9 069 806 | 14 | 9 070 138 | 60 | 9 070 580 | 39 |
| 0 115 016 | 8 | 0 115 218 | 15 | 9 069 807 | 14 | 9 070 142 | 96 | 9 070 581 | 79 |
| 0 115 017 | 8 | 0 115 263 | 95 | 9 069 808 | 14 | 9 070 143 | 96 | 9 070 583 | 29 |
| 0 115 018 | 8 | 0 115 264 | 95 | 9 069 815 | 71 | 9 070 144 | 96 | 9 070 585 | 79 |
| 0 115 019 | 19 | 0 115 266 | 84 | 9 069 818 | 71 | 9 070 147 | 96 | 9 070 586 | 79 |
| 0 115 020 | 19 | 0 115 292 | 94 | 9 069 821 | 71 | 9 070 148 | 96 | 9 070 588 | 29 |
| 0 115 021 | 20 | 0 115 293 | 94 | 9 069 865 | 71 | 9 070 149 | 96 | 9 070 589 | 79 |
| 0 115 022 | 20 | 0 115 298 | 36 | 9 069 867 | 70 | 9 070 263 | 38 | 9 070 593 | 29 |
| 0 115 023 | 20 | 0 115 312 | 77 | 9 069 868 | 70 | 9 070 264 | 38 | 9 070 602 | 70 |
| 0 115 024 | 20 | 0 115 314 | 36 | 9 069 873 | 70 | 9 070 420 | 71 | 9 070 605 | 70 |
| 0 115 028 | 35 | 0 115 353 | 15 | 9 069 877 | 70 | 9 070 421 | 71 | 9 070 619 | 70 |
| 0 115 049 | 35 | 0 115 354 | 15 | 9 069 890 | 44 | 9 070 429 | 70 | 9 070 624 | 61 |
| 0 115 060 | 48 | 0 115 355 | 15 | 9 069 892 | 70 | 9 070 439 | 70 | 9 070 625 | 70 |
| 0 115 076 | 50 | 0 115 356 | 15 | 9 069 893 | 44 | 9 070 440 | 69 | 9 070 674 | 17 |
| 0 115 077 | 45 | 0 115 357 | 15 | 9 069 899 | 70 | 9 070 443 | 70 | 9 070 675 | 67 |
| 0 115 078 | 45 | 0 115 358 | 15 | 9 069 900 | 70 | 9 070 444 | 70 | 9 070 681 | 67 |
| 0 115 080 | 72 | 0 115 359 | 15 | 9 069 907 | 70 | 9 070 446 | 69 | 9 070 693 | 100 |

| | | | | | | | | | |
|-----------|----|-----------|----|-----------|-----|-----------|-----|-----------|-----|
| 9 070 722 | 63 | 9 070 985 | 63 | 9 071 068 | 63 | 9 086 701 | 107 | 9 106 169 | 7 |
| 9 070 723 | 63 | 9 070 986 | 63 | 9 071 071 | 36 | 9 086 702 | 107 | 9 109 703 | 45 |
| 9 070 732 | 17 | 9 070 988 | 18 | 9 071 073 | 36 | 9 097 899 | 58 | 9 112 583 | 78 |
| 9 070 733 | 17 | 9 070 991 | 18 | 9 071 075 | 36 | 9 097 900 | 58 | 9 112 588 | 78 |
| 9 070 734 | 17 | 9 070 992 | 16 | 9 071 079 | 36 | 9 097 946 | 50 | 9 112 590 | 78 |
| 9 070 735 | 39 | 9 070 993 | 18 | 9 071 082 | 36 | 9 097 947 | 50 | 9 112 591 | 92 |
| 9 070 736 | 17 | 9 070 995 | 16 | 9 071 109 | 78 | 9 097 950 | 27 | 9 112 594 | 92 |
| 9 070 738 | 17 | 9 070 996 | 18 | 9 071 110 | 78 | 9 097 953 | 27 | 9 112 595 | 61 |
| 9 070 740 | 39 | 9 070 997 | 63 | 9 071 111 | 18 | 9 105 735 | 49 | 9 112 596 | 61 |
| 9 070 742 | 17 | 9 070 998 | 16 | 9 071 112 | 18 | 9 105 737 | 49 | 9 112 597 | 61 |
| 9 070 743 | 17 | 9 070 999 | 18 | 9 071 115 | 18 | 9 105 742 | 10 | 9 112 599 | 102 |
| 9 070 744 | 39 | 9 071 000 | 16 | 9 071 116 | 18 | 9 105 743 | 10 | 9 112 600 | 86 |
| 9 070 746 | 17 | 9 071 001 | 63 | 9 071 118 | 18 | 9 105 746 | 10 | 9 112 601 | 85 |
| 9 070 747 | 17 | 9 071 003 | 18 | 9 071 120 | 18 | 9 105 747 | 10 | 9 112 607 | 85 |
| 9 070 750 | 17 | 9 071 005 | 18 | 9 071 718 | 91 | 9 105 793 | 28 | 9 112 613 | 66 |
| 9 070 751 | 17 | 9 071 008 | 18 | 9 071 719 | 91 | 9 105 794 | 28 | 9 112 615 | 66 |
| 9 070 752 | 67 | 9 071 009 | 18 | 9 071 720 | 91 | 9 105 801 | 31 | 9 112 619 | 91 |
| 9 070 753 | 17 | 9 071 010 | 16 | 9 071 836 | 98 | 9 105 802 | 31 | 9 112 623 | 62 |
| 9 070 754 | 67 | 9 071 012 | 18 | 9 071 837 | 98 | 9 105 803 | 31 | 9 112 631 | 86 |
| 9 070 755 | 17 | 9 071 013 | 16 | 9 071 838 | 98 | 9 105 805 | 31 | 9 112 632 | 86 |
| 9 070 756 | 17 | 9 071 014 | 63 | 9 071 839 | 98 | 9 105 806 | 31 | 9 112 633 | 38 |
| 9 070 758 | 17 | 9 071 016 | 63 | 9 071 840 | 98 | 9 105 807 | 31 | 9 112 634 | 38 |
| 9 070 759 | 17 | 9 071 017 | 18 | 9 071 841 | 98 | 9 105 809 | 31 | 9 112 635 | 84 |
| 9 070 763 | 17 | 9 071 018 | 63 | 9 071 842 | 98 | 9 105 810 | 31 | 9 112 637 | 11 |
| 9 070 765 | 17 | 9 071 019 | 63 | 9 071 843 | 98 | 9 105 811 | 31 | 9 112 644 | 77 |
| 9 070 784 | 63 | 9 071 020 | 18 | 9 071 844 | 98 | 9 105 813 | 31 | 9 112 646 | 102 |
| 9 070 796 | 17 | 9 071 021 | 18 | 9 071 869 | 16 | 9 105 815 | 31 | 9 112 650 | 85 |
| 9 070 803 | 17 | 9 071 023 | 18 | 9 071 926 | 8 | 9 105 816 | 31 | 9 112 651 | 89 |
| 9 070 807 | 17 | 9 071 024 | 18 | 9 071 927 | 8 | 9 105 819 | 31 | 9 112 652 | 86 |
| 9 070 809 | 17 | 9 071 026 | 18 | 9 071 929 | 8 | 9 105 820 | 31 | 9 112 653 | 92 |
| 9 070 811 | 17 | 9 071 027 | 18 | 9 071 930 | 8 | 9 105 821 | 31 | 9 112 654 | 92 |
| 9 070 813 | 17 | 9 071 030 | 18 | 9 077 861 | 113 | 9 105 822 | 31 | 9 112 655 | 100 |
| 9 070 816 | 17 | 9 071 037 | 63 | 9 080 838 | 26 | 9 105 823 | 31 | 9 112 660 | 44 |
| 9 070 817 | 17 | 9 071 038 | 18 | 9 080 850 | 84 | 9 105 824 | 31 | 9 112 662 | 94 |
| 9 070 821 | 17 | 9 071 039 | 63 | 9 080 851 | 84 | 9 105 825 | 31 | 9 112 664 | 51 |
| 9 070 825 | 17 | 9 071 041 | 19 | 9 080 852 | 84 | 9 105 826 | 31 | 9 112 666 | 9 |
| 9 070 943 | 90 | 9 071 042 | 18 | 9 080 853 | 84 | 9 105 827 | 31 | 9 112 667 | 9 |
| 9 070 945 | 90 | 9 071 043 | 18 | 9 080 858 | 74 | 9 105 828 | 31 | 9 112 672 | 7 |
| 9 070 957 | 38 | 9 071 045 | 18 | 9 080 859 | 74 | 9 105 829 | 31 | 9 112 674 | 7 |
| 9 070 958 | 38 | 9 071 046 | 18 | 9 082 136 | 26 | 9 105 830 | 31 | 9 112 909 | 67 |
| 9 070 967 | 18 | 9 071 048 | 18 | 9 082 137 | 26 | 9 105 831 | 31 | 9 112 910 | 67 |
| 9 070 970 | 16 | 9 071 049 | 63 | 9 086 687 | 105 | 9 105 832 | 31 | 9 112 914 | 64 |
| 9 070 972 | 18 | 9 071 050 | 18 | 9 086 688 | 105 | 9 105 833 | 31 | 9 112 915 | 74 |
| 9 070 973 | 16 | 9 071 051 | 18 | 9 086 689 | 105 | 9 105 834 | 31 | 9 112 916 | 74 |
| 9 070 975 | 16 | 9 071 052 | 18 | 9 086 690 | 105 | 9 105 835 | 31 | 9 112 938 | 12 |
| 9 070 976 | 63 | 9 071 053 | 18 | 9 086 691 | 106 | 9 105 836 | 31 | 9 112 940 | 12 |
| 9 070 977 | 16 | 9 071 054 | 18 | 9 086 692 | 106 | 9 105 837 | 7 | 9 112 941 | 12 |
| 9 070 978 | 18 | 9 071 055 | 18 | 9 086 693 | 106 | 9 105 838 | 7 | 9 112 943 | 12 |
| 9 070 979 | 16 | 9 071 056 | 18 | 9 086 694 | 106 | 9 105 839 | 7 | 9 113 179 | 93 |
| 9 070 980 | 63 | 9 071 058 | 18 | 9 086 695 | 107 | 9 105 840 | 7 | 9 113 180 | 93 |
| 9 070 982 | 18 | 9 071 060 | 36 | 9 086 696 | 107 | 9 106 166 | 7 | 9 113 181 | 93 |
| 9 070 983 | 63 | 9 071 063 | 63 | 9 086 697 | 107 | 9 106 167 | 7 | 9 113 182 | 73 |
| 9 070 984 | 18 | 9 071 067 | 63 | 9 086 698 | 107 | 9 106 168 | 7 | 9 113 183 | 73 |

INDEX

Bestellnummernverzeichnis

Order Number Index

Index des références de commande

Overzicht bestelnummers

| | | | | | | | | | |
|-----------|-----|-----------|-----|-----------|-----|-----------|-----|-----------|----|
| 9 113 210 | 66 | 9 113 635 | 16 | 9 190 399 | 68 | 9 204 159 | 20 | 9 207 483 | 49 |
| 9 113 211 | 66 | 9 113 645 | 97 | 9 190 421 | 68 | 9 204 160 | 20 | 9 207 488 | 44 |
| 9 113 212 | 12 | 9 113 646 | 97 | 9 190 422 | 68 | 9 204 161 | 20 | 9 207 531 | 37 |
| 9 113 220 | 101 | 9 113 647 | 97 | 9 190 423 | 68 | 9 204 162 | 20 | 9 207 534 | 60 |
| 9 113 221 | 101 | 9 113 648 | 97 | 9 190 424 | 68 | 9 204 163 | 20 | 9 208 026 | 88 |
| 9 113 222 | 101 | 9 113 649 | 97 | 9 190 425 | 68 | 9 204 164 | 13 | 9 208 027 | 88 |
| 9 113 223 | 101 | 9 113 650 | 97 | 9 190 426 | 68 | 9 204 175 | 13 | 9 208 030 | 82 |
| 9 113 224 | 54 | 9 113 651 | 112 | 9 190 427 | 68 | 9 204 177 | 13 | 9 208 046 | 16 |
| 9 113 225 | 89 | 9 113 652 | 112 | 9 190 428 | 68 | 9 204 195 | 21 | 9 208 047 | 16 |
| 9 113 227 | 89 | 9 113 653 | 112 | 9 190 429 | 68 | 9 204 196 | 21 | 9 208 048 | 16 |
| 9 113 228 | 100 | 9 113 654 | 112 | 9 190 430 | 68 | 9 204 197 | 21 | 9 208 049 | 16 |
| 9 113 247 | 14 | 9 113 659 | 103 | 9 190 431 | 68 | 9 206 115 | 68 | 9 208 064 | 88 |
| 9 113 248 | 14 | 9 113 675 | 51 | 9 190 432 | 68 | 9 206 116 | 68 | 9 208 065 | 88 |
| 9 113 250 | 14 | 9 113 678 | 51 | 9 190 433 | 68 | 9 206 117 | 68 | 9 208 068 | 82 |
| 9 113 251 | 14 | 9 113 681 | 51 | 9 190 434 | 68 | 9 206 119 | 68 | 9 208 070 | 14 |
| 9 113 252 | 14 | 9 113 685 | 52 | 9 190 435 | 68 | 9 206 120 | 68 | 9 208 071 | 13 |
| 9 113 255 | 14 | 9 113 690 | 52 | 9 190 436 | 19 | 9 206 122 | 68 | 9 208 072 | 13 |
| 9 113 257 | 14 | 9 113 691 | 98 | 9 190 437 | 19 | 9 206 124 | 68 | 9 208 073 | 11 |
| 9 113 258 | 14 | 9 113 694 | 98 | 9 190 438 | 19 | 9 206 126 | 86 | 9 208 074 | 11 |
| 9 113 286 | 102 | 9 113 696 | 52 | 9 190 439 | 19 | 9 206 127 | 86 | 9 208 075 | 11 |
| 9 113 292 | 89 | 9 113 699 | 52 | 9 190 440 | 19 | 9 206 128 | 86 | 9 208 076 | 11 |
| 9 113 293 | 103 | 9 113 700 | 52 | 9 190 441 | 19 | 9 206 129 | 86 | 9 208 077 | 11 |
| 9 113 297 | 21 | 9 113 712 | 51 | 9 190 442 | 19 | 9 206 130 | 86 | 9 208 078 | 11 |
| 9 113 298 | 21 | 9 113 719 | 51 | 9 190 443 | 19 | 9 206 131 | 86 | 9 208 079 | 11 |
| 9 113 299 | 21 | 9 113 733 | 72 | 9 190 444 | 19 | 9 206 132 | 102 | 9 208 080 | 11 |
| 9 113 300 | 21 | 9 113 734 | 72 | 9 190 445 | 42 | 9 206 133 | 102 | 9 208 081 | 11 |
| 9 113 327 | 89 | 9 113 800 | 49 | 9 190 446 | 42 | 9 206 134 | 83 | 9 208 082 | 11 |
| 9 113 347 | 113 | 9 114 036 | 78 | 9 191 722 | 6 | 9 206 136 | 83 | 9 208 083 | 11 |
| 9 113 368 | 92 | 9 114 539 | 75 | 9 191 745 | 37 | 9 206 137 | 85 | 9 208 084 | 11 |
| 9 113 371 | 60 | 9 114 747 | 58 | 9 194 367 | 19 | 9 206 138 | 85 | 9 208 085 | 11 |
| 9 113 373 | 60 | 9 118 517 | 65 | 9 194 368 | 19 | 9 206 237 | 85 | 9 208 086 | 11 |
| 9 113 397 | 53 | 9 118 518 | 65 | 9 199 030 | 48 | 9 206 239 | 85 | 9 208 087 | 11 |
| 9 113 404 | 53 | 9 118 520 | 65 | 9 199 091 | 48 | 9 206 642 | 64 | 9 208 088 | 11 |
| 9 113 429 | 83 | 9 118 521 | 65 | 9 199 092 | 48 | 9 206 738 | 79 | 9 208 089 | 34 |
| 9 113 430 | 83 | 9 118 523 | 65 | 9 199 093 | 48 | 9 206 741 | 30 | 9 208 090 | 34 |
| 9 113 444 | 89 | 9 118 524 | 65 | 9 203 958 | 77 | 9 207 348 | 13 | 9 208 091 | 34 |
| 9 113 445 | 89 | 9 118 858 | 44 | 9 203 963 | 16 | 9 207 349 | 13 | 9 208 092 | 34 |
| 9 113 451 | 99 | 9 120 134 | 20 | 9 204 022 | 21 | 9 207 350 | 13 | 9 208 093 | 34 |
| 9 113 453 | 99 | 9 120 199 | 11 | 9 204 023 | 21 | 9 207 351 | 13 | 9 208 094 | 34 |
| 9 113 454 | 99 | 9 131 319 | 96 | 9 204 024 | 21 | 9 207 352 | 13 | 9 208 095 | 34 |
| 9 113 467 | 61 | 9 131 320 | 96 | 9 204 025 | 21 | 9 207 354 | 13 | 9 208 097 | 34 |
| 9 113 468 | 61 | 9 131 321 | 96 | 9 204 026 | 21 | 9 207 356 | 13 | 9 208 098 | 34 |
| 9 113 483 | 92 | 9 131 322 | 96 | 9 204 027 | 21 | 9 207 357 | 14 | 9 208 099 | 34 |
| 9 113 501 | 9 | 9 131 323 | 96 | 9 204 028 | 21 | 9 207 358 | 14 | 9 208 100 | 34 |
| 9 113 502 | 9 | 9 131 324 | 96 | 9 204 029 | 21 | 9 207 443 | 79 | 9 208 101 | 34 |
| 9 113 508 | 99 | 9 131 455 | 29 | 9 204 030 | 21 | 9 207 444 | 46 | 9 208 102 | 34 |
| 9 113 509 | 99 | 9 132 312 | 43 | 9 204 031 | 21 | 9 207 445 | 46 | 9 208 103 | 34 |
| 9 113 510 | 72 | 9 132 314 | 43 | 9 204 032 | 21 | 9 207 446 | 46 | 9 208 551 | 8 |
| 9 113 511 | 72 | 9 145 262 | 35 | 9 204 033 | 21 | 9 207 447 | 46 | 9 208 578 | 8 |
| 9 113 514 | 67 | 9 145 263 | 35 | 9 204 136 | 78 | 9 207 452 | 99 | 9 208 579 | 8 |
| 9 113 564 | 39 | 9 149 293 | 35 | 9 204 153 | 103 | 9 207 480 | 49 | 9 208 580 | 8 |
| 9 113 565 | 38 | 9 149 296 | 35 | 9 204 157 | 20 | 9 207 481 | 49 | 9 209 058 | 20 |
| 9 113 594 | 98 | 9 158 400 | 30 | 9 204 158 | 20 | 9 207 482 | 49 | 9 209 059 | 20 |

| | | | | | | | | | |
|-----------|-----|-----------|-----|-----------|----|-----------|-----|-----------|----|
| 9 209 060 | 20 | 9 264 081 | 44 | 9 265 988 | 31 | 9 266 415 | 59 | 9 995 585 | 9 |
| 9 209 061 | 20 | 9 264 082 | 44 | 9 265 989 | 31 | 9 266 416 | 59 | 9 995 586 | 9 |
| 9 209 062 | 20 | 9 264 084 | 44 | 9 265 990 | 31 | 9 266 417 | 42 | 9 995 587 | 9 |
| 9 209 063 | 20 | 9 264 085 | 44 | 9 265 991 | 31 | 9 266 418 | 42 | 9 995 588 | 9 |
| 9 209 064 | 20 | 9 264 086 | 27 | 9 265 992 | 31 | 9 266 419 | 87 | 9 995 589 | 9 |
| 9 209 994 | 76 | 9 264 087 | 11 | 9 265 993 | 31 | 9 266 420 | 87 | 9 995 590 | 9 |
| 9 209 995 | 76 | 9 264 088 | 49 | 9 265 994 | 31 | 9 266 561 | 101 | 9 995 771 | 47 |
| 9 209 996 | 76 | 9 265 879 | 15 | 9 265 997 | 76 | 9 266 562 | 93 | 9 995 772 | 47 |
| 9 209 997 | 76 | 9 265 880 | 15 | 9 265 998 | 76 | 9 266 563 | 93 | 9 995 773 | 47 |
| 9 210 058 | 76 | 9 265 885 | 77 | 9 265 999 | 76 | 9 266 564 | 93 | 9 995 780 | 47 |
| 9 210 059 | 76 | 9 265 886 | 103 | 9 266 000 | 76 | 9 266 565 | 93 | 9 995 781 | 47 |
| 9 210 060 | 76 | 9 265 887 | 60 | 9 266 001 | 76 | 9 266 566 | 85 | 9 995 782 | 47 |
| 9 210 061 | 76 | 9 265 888 | 15 | 9 266 002 | 76 | 9 266 567 | 85 | | |
| 9 210 062 | 76 | 9 265 921 | 15 | 9 266 003 | 76 | 9 266 568 | 85 | | |
| 9 210 063 | 76 | 9 265 922 | 15 | 9 266 004 | 76 | 9 268 219 | 12 | | |
| 9 210 115 | 22 | 9 265 923 | 15 | 9 266 005 | 76 | 9 268 262 | 12 | | |
| 9 210 116 | 22 | 9 265 924 | 15 | 9 266 006 | 76 | 9 269 731 | 12 | | |
| 9 210 117 | 22 | 9 265 925 | 15 | 9 266 067 | 76 | 9 269 732 | 12 | | |
| 9 210 119 | 22 | 9 265 926 | 15 | 9 266 068 | 76 | 9 269 733 | 47 | | |
| 9 210 122 | 23 | 9 265 927 | 15 | 9 266 069 | 76 | 9 269 734 | 47 | | |
| 9 210 125 | 23 | 9 265 928 | 15 | 9 266 070 | 76 | 9 269 735 | 47 | | |
| 9 210 126 | 23 | 9 265 929 | 15 | 9 266 071 | 76 | 9 269 736 | 47 | | |
| 9 210 128 | 23 | 9 265 930 | 15 | 9 266 072 | 76 | 9 269 741 | 53 | | |
| 9 210 129 | 23 | 9 265 931 | 15 | 9 266 073 | 76 | 9 269 742 | 53 | | |
| 9 210 129 | 25 | 9 265 932 | 15 | 9 266 074 | 76 | 9 270 230 | 87 | | |
| 9 210 130 | 24 | 9 265 933 | 15 | 9 266 075 | 76 | 9 270 437 | 47 | | |
| 9 210 132 | 24 | 9 265 934 | 15 | 9 266 076 | 76 | 9 270 438 | 47 | | |
| 9 210 133 | 24 | 9 265 935 | 15 | 9 266 077 | 68 | 9 270 439 | 47 | | |
| 9 210 136 | 24 | 9 265 936 | 15 | 9 266 078 | 68 | 9 277 179 | 59 | | |
| 9 210 138 | 25 | 9 265 937 | 15 | 9 266 079 | 68 | 9 995 122 | 32 | | |
| 9 210 139 | 25 | 9 265 938 | 15 | 9 266 080 | 68 | 9 995 123 | 32 | | |
| 9 210 140 | 25 | 9 265 939 | 15 | 9 266 091 | 68 | 9 995 437 | 29 | | |
| 9 210 141 | 25 | 9 265 940 | 15 | 9 266 092 | 68 | 9 995 438 | 29 | | |
| 9 210 142 | 23 | 9 265 941 | 15 | 9 266 093 | 68 | 9 995 439 | 29 | | |
| 9 210 142 | 25 | 9 265 942 | 15 | 9 266 094 | 68 | 9 995 440 | 29 | | |
| 9 210 143 | 23 | 9 265 943 | 15 | 9 266 095 | 34 | 9 995 480 | 47 | | |
| 9 210 143 | 25 | 9 265 949 | 29 | 9 266 096 | 34 | 9 995 481 | 47 | | |
| 9 212 860 | 112 | 9 265 950 | 29 | 9 266 097 | 34 | 9 995 482 | 47 | | |
| 9 237 970 | 33 | 9 265 971 | 29 | 9 266 098 | 34 | 9 995 483 | 47 | | |
| 9 252 428 | 12 | 9 265 972 | 29 | 9 266 099 | 34 | 9 995 484 | 47 | | |
| 9 252 429 | 12 | 9 265 973 | 31 | 9 266 100 | 34 | 9 995 485 | 47 | | |
| 9 252 430 | 12 | 9 265 975 | 31 | 9 266 101 | 34 | 9 995 497 | 73 | | |
| 9 260 744 | 100 | 9 265 976 | 31 | 9 266 102 | 34 | 9 995 498 | 73 | | |
| 9 264 060 | 87 | 9 265 977 | 31 | 9 266 104 | 22 | 9 995 499 | 73 | | |
| 9 264 072 | 45 | 9 265 978 | 31 | 9 266 105 | 22 | 9 995 500 | 73 | | |
| 9 264 073 | 45 | 9 265 979 | 31 | 9 266 106 | 23 | 9 995 501 | 73 | | |
| 9 264 074 | 44 | 9 265 980 | 31 | 9 266 107 | 23 | 9 995 540 | 30 | | |
| 9 264 075 | 44 | 9 265 981 | 31 | 9 266 132 | 24 | 9 995 541 | 30 | | |
| 9 264 076 | 44 | 9 265 982 | 31 | 9 266 133 | 24 | 9 995 542 | 30 | | |
| 9 264 077 | 44 | 9 265 983 | 31 | 9 266 134 | 25 | 9 995 546 | 47 | | |
| 9 264 078 | 44 | 9 265 985 | 31 | 9 266 135 | 25 | 9 995 547 | 47 | | |
| 9 264 079 | 44 | 9 265 986 | 31 | 9 266 141 | 77 | 9 995 548 | 47 | | |
| 9 264 080 | 44 | 9 265 987 | 31 | 9 266 142 | 77 | 9 995 574 | 30 | | |

Impressum:

© Hettich Marketing- und Vertriebs GmbH & Co. KG
Gerhard-Lüking-Str. 10
32602 Vlotho, Deutschland

Für diesen Katalog behalten wir uns alle Rechte aus dem Urheberrecht vor. Ohne unsere schriftliche Genehmigung ist es nicht gestattet, den Katalog oder Teile daraus in irgendeiner Form zu vervielfältigen.
Technische Änderungen vorbehalten.
Keine Gewährleistung für Druckfehler oder Irrtümer.
Farbabweichungen vorbehalten.

März 2020
Bestell-Nr.: 9 279 364

Publisher's imprint

© Hettich Marketing- und Vertriebs GmbH & Co. KG
Gerhard-Lüking-Str. 10
32602 Vlotho, Germany

We reserve all rights to this catalogue under copyright law. It shall not be permissible to duplicate this catalogue in any form either in whole or in part without our written consent.
Subject to technical alterations.
Errors and omissions excepted.
Subject to colour variations.

March 2020
Order no.: 9 279 364

Note de l'éditeur

© Hettich Marketing- und Vertriebs GmbH & Co. KG
Gerhard-Lüking-Str. 10
32602 Vlotho, Allemagne

Tous droits d'auteurs nous sont réservés pour ce catalogue. Toute reproduction ou représentation, intégrale ou partielle, faite sans notre autorisation écrite est illicite. Sous réserve de modifications techniques. Nous déclinons toute responsabilité pour d'éventuelles erreurs ou fautes d'impression. Sous réserve de différences de couleur.

Mars 2020
Référence : 9 279 364

Impressum:

© Hettich Marketing- und Vertriebs GmbH & Co. KG
Gerhard-Lüking-Str. 10
32602 Vlotho, Duitsland

Voor deze catalogus behouden wij ons alle auteursrechten voor. Zonder onze schriftelijke toestemming is het verboden deze catalogus of delen daarvan in welke vorm dan ook te vermenigvuldigen.
Technische wijzigingen vorbehalten.
Wij zijn niet aansprakelijk voor drukfouten of andere vergissingen.
Kleurafwijkingen vorbehalten.

Maart 2020
Bestelnr.: 9 279 364

Lernen Sie das Familien-
unternehmen Hettich
näher kennen!

Learn more about the
Hettich family-owned company
and get to know us better!

Apprenez-en plus sur l'entreprise
familiale Hettich !

Leer het familiebedrijf
Hettich beter kennen!

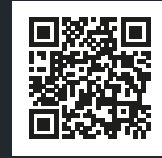

Bestell-Nr.: 9 279 364
1908-044_ProDeco_Basiskg_03/20_HMM/de/en/fr/nl

INTERFER

Rua Neves Ferreira, 3-B
1170-273 LISBOA - PORTUGAL
Tlf: +351 218 110 600 (20 Linhas)
fax +351 218 150 026
www.interfer.pt
geral@interfer.pt

Technik für Möbel

Hettich