

**ESTAMP**<sup>®</sup>  
High quality handles

**ESTAMP**<sup>®</sup>  
High quality handles

**INTERFER**

ESTAMP

Herrajes para muebles / Garnitures pour meubles / Furniture fittings / Möbelbeschläge

J.JOSÉ VERGÉS S.A.  
1928



**J.JOSÉ VERGÉS S.A.**  
1928

Avda. de Cornellà, 140 bajos  
Edificio LEKLA  
08950 Esplugues de Llobregat  
Barcelona - Spain

Tel. Nacional 933 713 954\*

Fax Nacional 933 725 302

International Tel. 34 933 713 958\*

International Fax 34 933 725 302

Email: [estamp@verges.com](mailto:estamp@verges.com)

[www.verges.com](http://www.verges.com)



**J.JOSÉ VERGÉS S.A.**  
1928





**ESTAMP**<sup>®</sup>

*High quality handles*

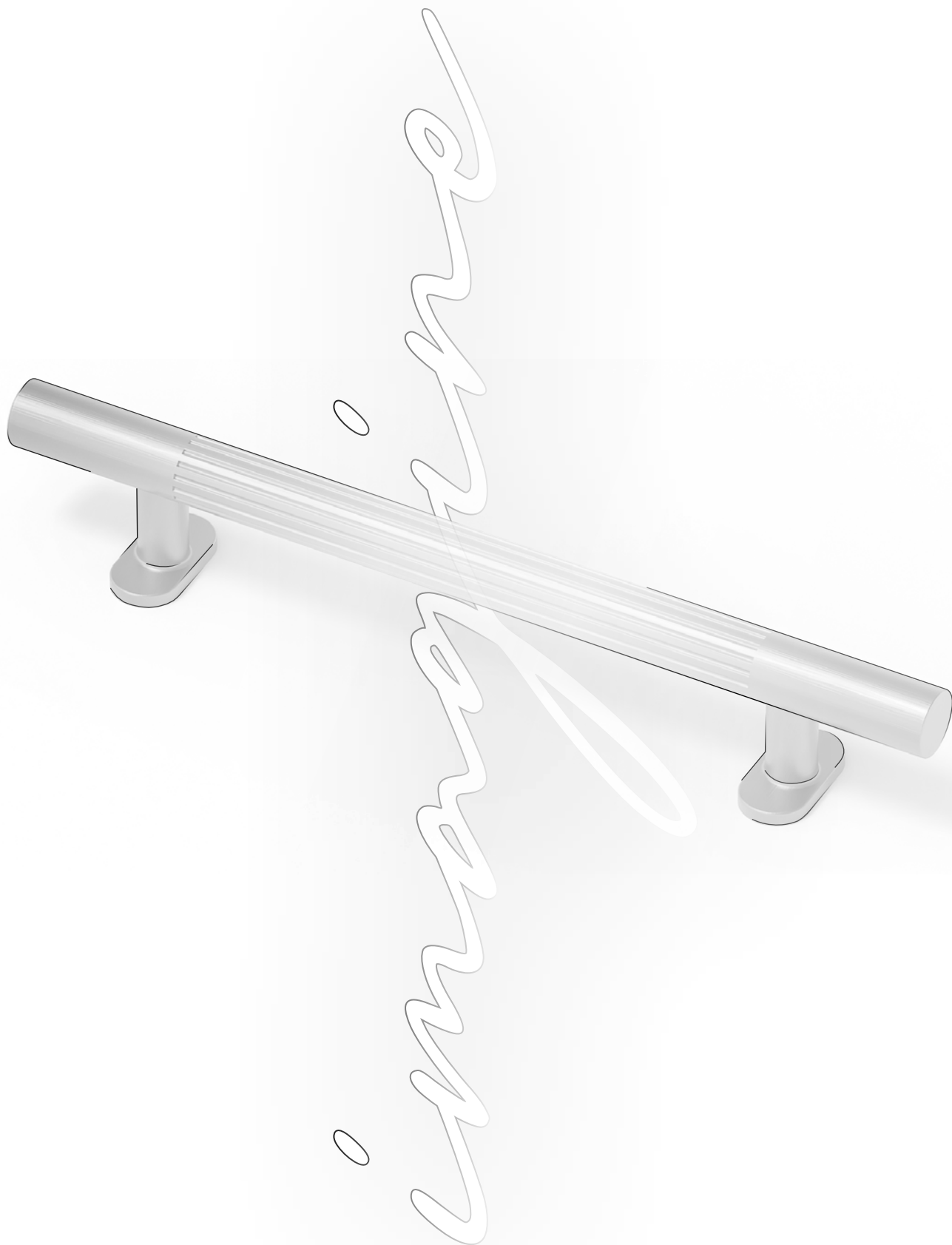

## Índice de referencias

*Index de références*

Index of references

*Verzeichnis der Referenzen*

102A	109	3512	69	6190	38	7002	76	7491	88	8090	63	8922	77
102B	109	3541	59	6191	38	7003	76	7492	88	8101	55	9011	17
102C	110	3542	59	6200	39	7004	76	7501	76	8102	55	9012	17
102D	110	3560	69	6201	39	7005	76	7502	76	8103	55	9062	79
102E	110	3561	69	6210	40	7006	76	7503	76	8151	46	9063	79
1000	107	3562	69	6211	40	7007	76	7504	76	8152	46	9090	57
1001	107	3600	69	6231	36	7008	76	7505	76	8161	47	9381	57
1002	107	3701	80	6232	36	7009	76	7506	76	8162	47	9382	57
1003	107	3702	80	6240	27	7010	77	7511	102	8171	47	9383	57
1004	107	3703	80	6241	26	7011	77	7512	102	8172	47	9400	16
1005	108	3720	60	6242	26	7012	77	7513	102	8181	21	9401	16
1006	108	3730	61	6521	84	7013	77	7520	62	8182	21	9402	16
1007	108	3740	60	6601	18	7014	77	7521	62	8191	90	9403	16
1008	108	3750	58	6602	18	7015	77	7531	53	8192	90	9404	16
1009	108	3760	34	6603	18	7016	77	7532	53	8321	74	9405	16
1020	107	3770	34	6604	18	7017	77	7541	55	8322	74	9411	15
1021	107	3780	34	6611	19	7018	77	7542	55	8323	74	9412	15
1022	107	3790	35	6612	19	7019	77	7543	55	8324	74	9413	15
1023	107	3801	83	6613	19	7020	62	7552	73	8341	22	9414	15
1024	107	3802	83	6614	19	7021	62	7553	73	8342	22	9501	96
1025	108	3900	83	6761	50	7022	62	7554	73	8351	74	9502	96
1026	108	3921	82	6762	50	7023	62	7570	52	8352	74	9551	96
1027	108	3922	82	6763	50	7024	62	7571	52	8353	74	9552	96
1028	108	3930	83	6764	50	7025	62	7572	52	8354	74	9651	96
1029	108	3940	80	6765	50	7026	62	7581	86	8361	78	9652	96
1030	109	3961	30	6781	44	7031	67	7582	86	8362	78	9700	94
1101	105	5001	78	6782	44	7032	67	7610	76	8363	78	9770	95
1102	105	5002	78	6791	41	7051	66	7611	76	8461	75	9771	95
1103	105	5101	78	6792	41	7052	66	7612	76	8462	75	9772	95
1104	105	5102	78	6801	36	7061	72	7613	76	8463	75	9821	93
1105	105	5201	79	6802	36	7081	72	7614	76	8471	75	9822	93
1106	106	5202	79	6803	36	7082	72	7651	58	8472	75	9831	93
1107	106	5221	79	6811	42	7131	66	7652	58	8473	75	9832	93
1108	106	5222	79	6812	42	7132	66	7653	58	8491	88	9841	94
1109	106	5611	98	6821	32	7140	66	7661	56	8521	84	9842	94
1801	48	5612	98	6822	32	7150	71	7662	56	8581	86	9851	94
1802	48	5613	98	6831	31	7191	90	7663	56	8651	93	9852	94
1803	48	5614	98	6832	31	7192	90	7681	61	8652	93	9932	97
1810	49	5615	99	6841	22	7241	64	7682	61	8653	93	9933	97
1820	49	5616	99	6842	22	7242	64	7683	61	8671	70	9952	97
1830	49	5617	99	6843	22	7251	92	7684	61	8672	70	9953	97
2000	104	5618	99	6851	24	7252	92	7691	54	8673	70	9991	97
2111	103	5619	99	6852	24	7281	70	7692	54	8701	71	9992	97
2112	103	5621	100	6853	24	7282	70	7693	54	8702	71	9993	97
2211	103	5622	100	6860	28	7291	70	7694	54	8711	71		
2212	103	5623	100	6861	28	7292	70	7751	53	8712	71		
2840	45	5624	100	6862	28	7321	65	7810	76	8721	75		
2850	45	5625	100	6863	28	7322	65	7811	76	8722	75		
2860	45	5626	101	6871	21	7371	91	7812	76	8731	72		
2880	89	5627	101	6872	21	7372	91	7813	76	8732	72		
3251	81	5628	101	6873	21	7421	87	7814	76	8800	65	ED-15	112
3252	81	5629	101	6880	14	7422	87	7830	92	8820	73	M-45	111
3261	80	6100	37	6881	14	7461	62	7861	67	8830	73	T-14	112
3262	81	6111	37	6882	14	7462	62	7861	78	8841	91	T-21	112
3271	82	6112	37	6883	14	7463	62	7862	67	8842	91	T-25	112
3272	82	6130	85	6884	14	7471	63	7862	78	8851	64	T-31	112
3281	68	6131	84	6891	20	7472	63	7921	77	8852	64	T-35	112
3282	68	6132	84	6892	20	7473	63	7922	77	8871	87	T-40	112
3500	69	6150	85	6893	20	7481	63	7923	77	8891	20	T-60	112
3510	69	6151	85	7000	76	7482	63	8010	74	8892	20	231	112
3511	69	6152	85	7001	76	7483	63	8080	62	8921	77	232	112

Tornillos y cerrres  
Vis et fermetures  
Screws and locks  
Schrauben und  
Druckverschlüsse

© J. José Vergés S.A., 2022

Avda. de Cornellá, 140 bajos  
Edificio LEKLA  
08950 Esplugues de Llobregat  
Barcelona - Spain  
Tel. Nacional 933 713 954\*  
Fax Nacional 933 725 302  
International Tel. 34 933 713 958\*  
International Fax 34 933 725 302  
Email: estamp@verges.com  
www.verges.com

Los acabados mostrados  
en este catálogo  
son aproximados e  
ilustrativos y pueden  
variar ligeramente del  
color real.

Les finitions montrées  
dans ce catalogue sont  
approximées et illustratives  
et elles peuvent varier  
légèrement de la couleur  
réelle.

The finishes displayed  
in this catalogue are  
approximate and may vary  
illustrative and may vary  
slightly from the actual  
colour.

Die in diesem Katalog  
gezeigten Oberflächen  
sind ungefähre Angaben  
und können von der  
tatsächlichen Farbe  
abweichen.

## 95 años de continua evolución

*95 ans de continue évolution*

95 years in constant evolution

*95 Jahre kontinuierlicher Evolution*

En Estamp cumplimos 95 años. Casi un siglo en el que hemos fabricado y vendido millones de artículos en todo el mundo.

Nada de esto hubiera sido posible sin la inestimable cooperación de todos y cada uno de nuestros colaboradores, dentro y fuera de nuestra empresa. Tampoco sin la creatividad y el acierto de nuestros diseñadores y la colaboración de nuestros proveedores. Es por eso que hoy queremos agradecer a todos ellos que nos hayan acompañado durante este largo viaje, e invitarles a que sigan haciéndolo durante muchos más.

*Chez Estamp, nous avons 95 ans. Presque un siècle dans lequel nous avons fabriqué et vendu millions d'articles dans le monde entier.*

*Rien de cela aurait été possible sans l'inestimable coopération de tous et chacun de nos collaborateurs, dans et hors de notre entreprise. Aussi sans la créativité et le succès de nos designers et avec la collaboration de nos fournisseurs. C'est pour cela qu'aujourd'hui nous voulons remercier à tous ceux qui nous ont accompagnés pendant ce long voyage et les inviter à continuer de le faire pendant beaucoup plus.*

At Estamp we celebrate our 95th birthday. Nearly a century during which we have manufactured and sold millions of articles worldwide.

This would not have been possible without the valuable co-operation of each and every one of our teammates, inside and outside our company. Nor without the creativity and the success of our designers and the co-operation of our suppliers. So today we wish to thank them all for walking beside us during this long journey, and to invite them to go on doing so for many more years to come.

*Bei Estamp feiern wir 95 jähriges Jubiläum. Fast ein Jahrhundert, in dem wir Millionen Artikel hergestellt und weltweit verkauft haben.*

*All dies wäre nicht möglich gewesen ohne die unschätzbare Zusammenarbeit mit jedem einzelnen Mitarbeiter, innerhalb und außerhalb unseres Unternehmens, und überdies der Kreativität und dem Geschick unserer Designer sowie der Beteiligung unserer Lieferanten. Deshalb möchten wir uns heute bei allen bedanken, die uns auf dieser langen Reise begleitet haben und Sie einladen, dies noch für viele weitere Jahre zu tun.*

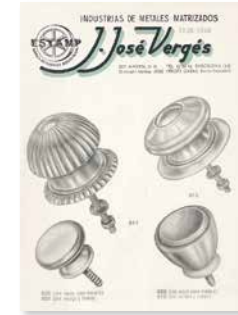

### Calidad y perfección *Qualité et perfection* Quality and perfection *Qualität und Perfektion*

La calidad y perfección siempre han sido nuestra divisa y la clave de nuestro éxito, por eso la hemos hecho extensiva a todos nuestros ámbitos de actividad, tanto de producción como humanos.

*La qualité et la perfection ont été toujours notre devise et la clé de notre succès, pour cela nous l'avons étendu à tous nos cadres d'activité tant en production comme humains.*

Quality and perfection have always been our trademark and the key to our success. This is why we have extended them to all our areas of activity, as much in production as in human resources.

*Qualität und Perfektion sind seit jeher unser Motto und der Schlüssel unseres Erfolges. Aus diesem Grund haben wir es auf alle Tätigkeitsbereiche ausgedehnt, sowohl in der Produktion als auch das Personal betreffend.*



Spheres







**Empeño en la perfección**  
*L'Effort de la perfection*  
 Endeavor for perfection  
 Das Bekenntnis zur Perfektion

Grooves

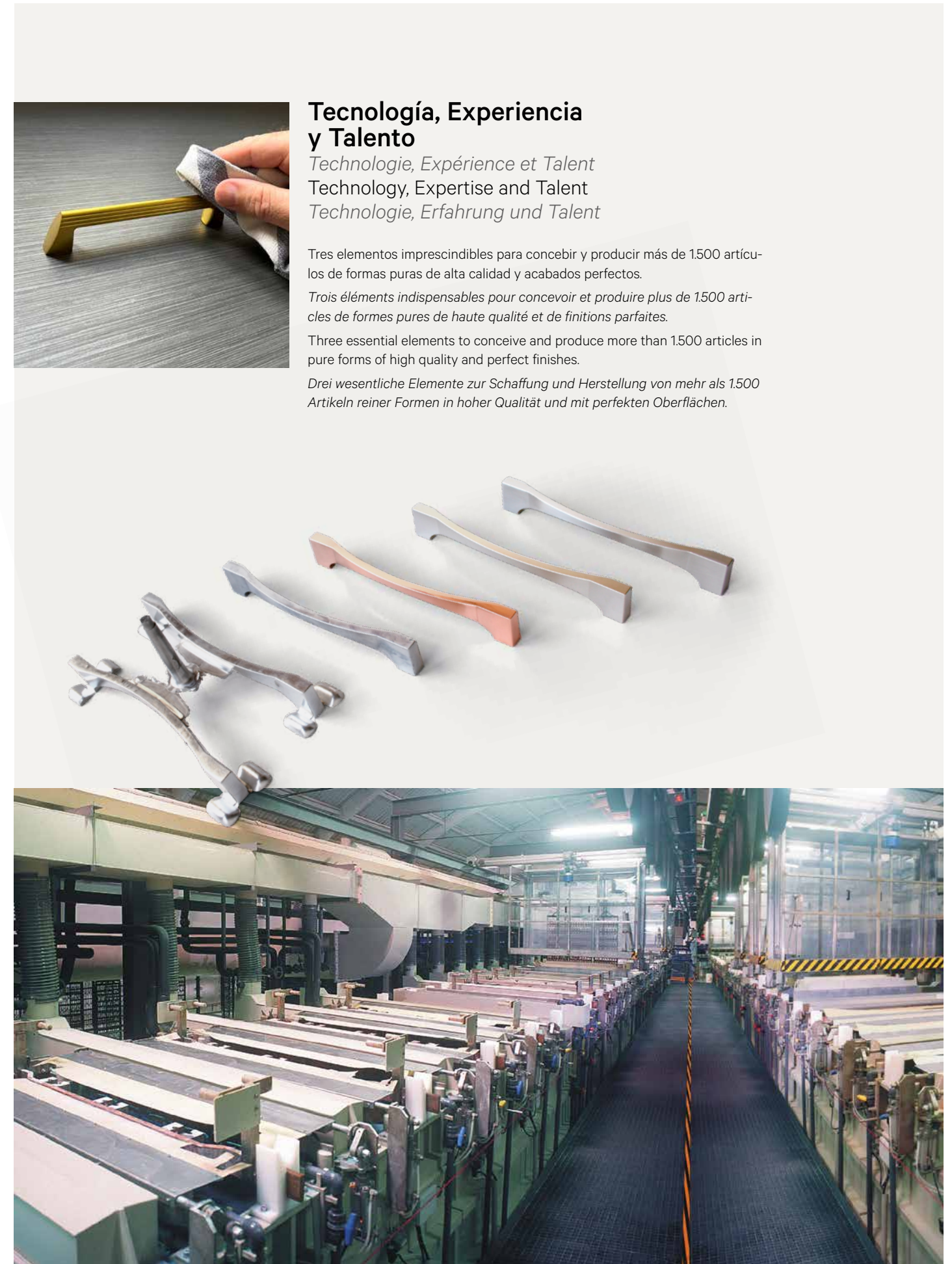
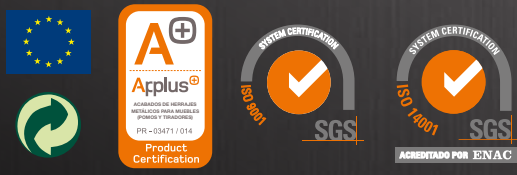

**Tecnología, Experiencia y Talento**

*Technologie, Expérience et Talent*  
 Technology, Expertise and Talent  
 Technologie, Erfahrung und Talent

Tres elementos imprescindibles para concebir y producir más de 1.500 artículos de formas puras de alta calidad y acabados perfectos.  
*Trois éléments indispensables pour concevoir et produire plus de 1.500 articles de formes pures de haute qualité et de finitions parfaites.*  
 Three essential elements to conceive and produce more than 1.500 articles in pure forms of high quality and perfect finishes.  
*Drei wesentliche Elemente zur Schaffung und Herstellung von mehr als 1.500 Artikeln reiner Formen in hoher Qualität und mit perfekten Oberflächen.*



**Diseño creativo**

*Design créatif*  
Creative design  
*Kreatives Design*



**Swing**  
Balutto Associati



Balutto Associati

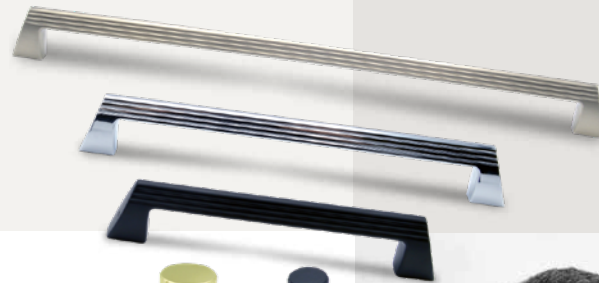

**ProFit**  
Josep J. Teruel



**Grooves**  
Ramón Segarra



Ramón Segarra

**Creando tendencias**

*En créant des tendances*  
Creating trends  
*Trends setzen*

Afamados y experimentados diseñadores, innovan día a día para crear piezas únicas y nuevas colecciones.

*Renommés et expérimentés designers innoverent jour à jour pour créer de pièces uniques et de nouvelles collections.*

Renowned and experienced designers innovate every day to create unique pieces and new collections.

*Renommierter und erfahrene Designer innovieren Tag für Tag, um einzigartige Stücke und neue Kollektionen zu kreieren.*



Josep J. Teruel



**Laps**  
Jorge Navarro



Jorge Navarro

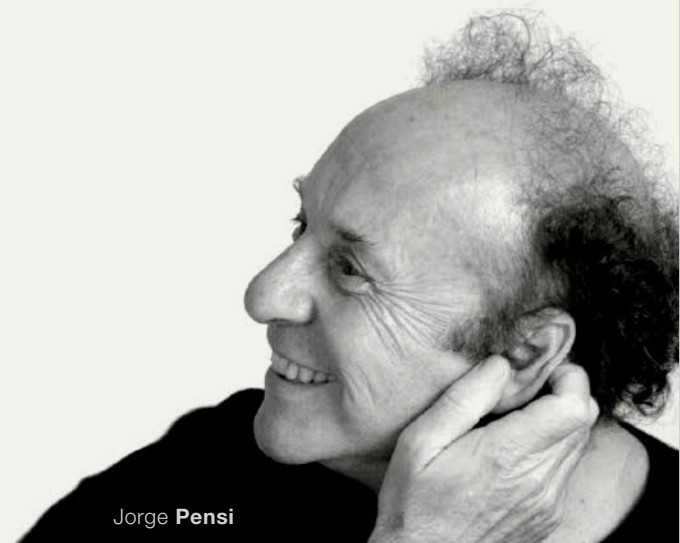

Jorge Pensi



**Circle**  
Jorge Pensi Design Studio

*innovazione*



**El medio ambiente: nuestro compromiso**

*L'environnement : notre objectif*  
 Environment is our aim  
 Umweltschutz: unser Ziel

En Estamp estamos plenamente comprometidos con la conservación del medio ambiente y es por eso que fuimos de las primeras empresas de nuestro sector en obtener la certificación ISO 14001 que nos acredita como fabricantes que utilizan procesos productivos no contaminantes y es también por eso que nos aseguramos que nuestros productos se fabriquen utilizando materiales que, como en el caso de la madera, permitan la sostenibilidad de los recursos naturales de nuestro planeta.

*Chez Estamp, nous sommes pleinement engagés dans la préservation de l'environnement et pour cette raison, nous avons été l'une des premières entreprises de notre secteur à obtenir la certification ISO 14001 qui nous accrédite comme fabricants qui utilisent des processus de production non polluants. Nous veillons à ce que nos produits soient fabriqués en utilisant des matériaux qui, comme dans le cas du bois, permettent la durabilité des ressources naturelles de notre planète.*

At Estamp we are fully committed to environmental sustainability and this is the reason why we were among the first companies in our sector to obtain the ISO 14001 certification that attests us as manufacturers using non-polluting production processes. This is also why we ensure that our products are manufactured using materials that, as in the case of wood, allow for the sustainability of our planet's natural resources.

*Bei Estamp setzen wir uns voll und ganz für den Umweltschutz ein. Deshalb haben wir als eines der ersten Unternehmen unserer Branche die ISO 14001-Zertifizierung erhalten, die uns als Hersteller mit umweltfreundlichen Produktionsprozessen ausweist. Wir achten darauf, dass unsere Produkte aus Materialien wie beispielsweise Holz hergestellt werden, die Nachhaltigkeitsanforderungen erfüllen.*



**Protegiendo nuestro mundo**  
*En protégeant notre monde*  
 Protecting our world  
 Schutz unserer Umwelt

Expertos en fabricar con la mejor calidad y el máximo respeto al medioambiente.  
*Experts dans la fabrication avec la plus haute qualité et maximum de respect pour l'environnement.*  
 Experts in manufacturing with the highest quality and maximum respect for the environment.  
*Experten bei der Herstellung in hochwertiger Qualität und maximalem Respekt für die Umwelt.*





**Conectados con nuestros clientes**

Connecté avec nos clients  
 Connected with our clients  
 Verbunden mit unseren Kunden

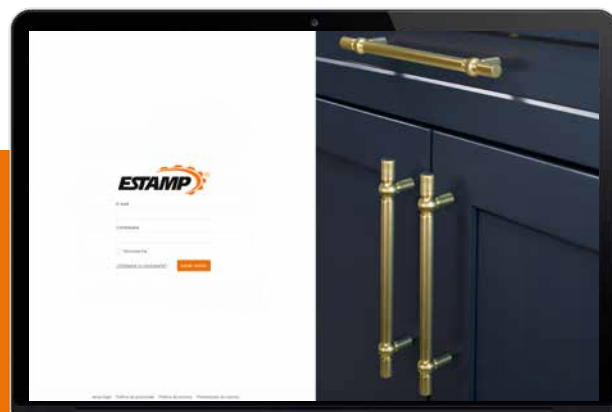

Descubra las últimas novedades  
 Découvrez les dernières nouvelles  
 Discover the latest news  
 Entdecken Sie die neuesten Nachrichten  
[www.verges.com](http://www.verges.com)



**Marketing y Merchandising**  
 Marketing et Merchandising  
 Marketing and Merchandising  
 Marketing und Merchandising

En Estamp disponemos de un amplio equipo profesional dedicado al trato con el distribuidor para asesorarle de las mejores opciones comerciales para su punto de venta. Ponemos a su alcance una amplia variedad de herramientas que le ayudarán a conocer y, a la vez, dar a conocer mejor nuestros productos.

Chez Estamp, nous disposons d'une large équipe professionnelle dédiée au traitement avec le distributeur pour leur conseiller les meilleures options commerciales pour leur point de vente. Nous avons à leur disposition une vaste variété d'outils qui lui aideront à connaître et en même temps, donner à connaître mieux nos produits.

At Estamp we have a large professional team dedicated to deal with the distributor, to advise them of the best commercial options for their point of sale. We put at their disposal a wide variety of tools that will help you to know our product and, at the same time, make it better known.

Bei Estamp haben wir ein vielgestaltiges Team, das mit den Vertreibern in Verbindung steht. Es berät sie über die beste kommerzielle Option für Ihre Verkaufsabteilung. Ihnen steht eine breitgefächerte Vielfalt an Instrumenten zur Verfügung, die Ihnen helfen, unsere Produkte besser kennen zu lernen und gleichzeitig bekannter zu machen.



38,5 x 50 cm  
 40 x 90 cm

49 x 201 cm





**Fluted**

Zamak	B	C	D
6880	56	14	34

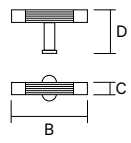

**Fluted**

Zamak	A	E	B	C	D
6881	2 x 491	982	1040	14	34
6882	480		538	14	34
6883	320		378	14	34
6884	192		250	14	34

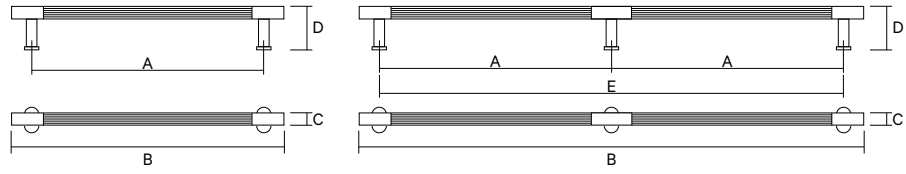

Acabado / Finition / Finish / Oberfläche

		
<b>220</b> Oro cepillado anodizado Or brossé anodisé Brushed gold anodized Goldfarben gebürstet eloxiert	<b>232</b> Negro mate anodizado Noir mat anodisé Dull black anodized Schwarz matt eloxiert	<b>238</b> Níquel cepillado anodizado Nickelé brossé anodisé Brushed nickel anodized Vernickelt gebürstet eloxiert



Otras longitudes disponibles bajo demanda y sujetas a cantidades mínimas a consultar.  
Autres longueurs disponibles sur demande et sous réserve de quantités minimales à consulter.  
Other lengths available and subject to minimum quantities on request.  
Andere Längen auf Anfrage erhältlich, vorbehaltlich Mindestmengen.

**Timber**

Madera / Bois / Wood / Holz	A	E	B	C	D
9411	3 x 352	1056	1110	24	12
9412	320		400	24	12
9413	192		250	24	12
9414	32		60	24	12

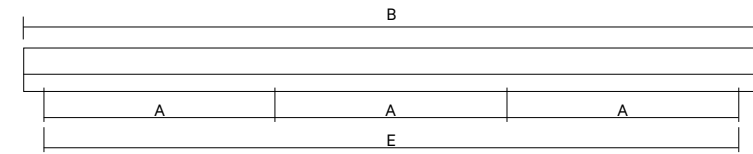
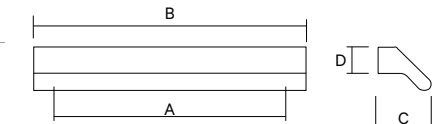

Acabado / Finition / Finish / Oberfläche

	
<b>017</b> Arce barniz natural Érable vernis naturel Maple clear varnished Ahorn klar lackiert	<b>046</b> Arce barniz wengué Érable vernis wengué Maple wenge varnished Ahorn wenge lackiert





**Round**

Zamak - Madera / Bois / Wood / Holz

	B	C	D
9400	68	15	34

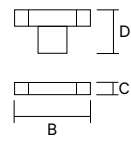

**Round**

Zamak - Madera / Bois / Wood / Holz

	A	E	B	C	D
9401	2 x 480	960	996	15	34
9402	480		516	15	34
9403	320		356	15	34
9404	192		228	15	34
9405	160		196	15	34

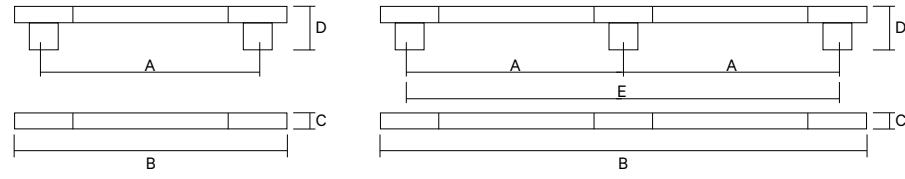

Acabado / Finition / Finish / Oberfläche



217

Oro cepillado arce barniz natural  
Or brossé érable vernis naturel  
Brushed gold, maple clear varnished  
Goldfarben gebürstet, Ahorn klar lackiert



246

Oro cepillado arce barniz wengué  
Or brossé érable vernis wengué  
Brushed gold, maple wenge varnished  
Goldfarben gebürstet, Ahorn wenge lackiert



317

Niquel cepillado arce barniz natural  
Nickelé brossé érable vernis naturel  
Brushed nickel, maple clear varnished  
Vernickelt gebürstet, Ahorn klar lackiert



346

Niquel cepillado arce barniz wengué  
Nickelé brossé érable vernis wengué  
Brushed nickel, maple wenge varnished  
Vernickelt gebürstet, Ahorn wenge lackiert



617

Negro mate arce barniz natural  
Noir mat érable vernis naturel  
Dull black, maple clear varnished  
Schwarz matt, Ahorn klar lackiert



646

Negro mate arce barniz wengué  
Noir mat érable vernis wengué  
Dull black, maple wenge varnished  
Schwarz matt, Ahorn wenge lackiert

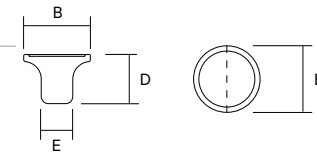

**Forest**

Madera / Bois / Wood / Holz

	B	D	E
9011	38	28	18
9012	30	25	14

Acabado / Finition / Finish / Oberfläche



011

Madera barniz natural  
Bois vernis naturel  
Wood clear varnished  
Holz klar lackiert



049

Madera barniz wengué  
Bois vernis wengué  
Wood wenge varnished  
Holz wenge lackiert





**Slot**

Aluminio / Aluminium / Aluminium / Aluminium

	A	E	B	C	D
6601	3 x 352	1056	1110	42	17
6602	320		400	42	17
6603	192		250	42	17
6604	32		50	42	17

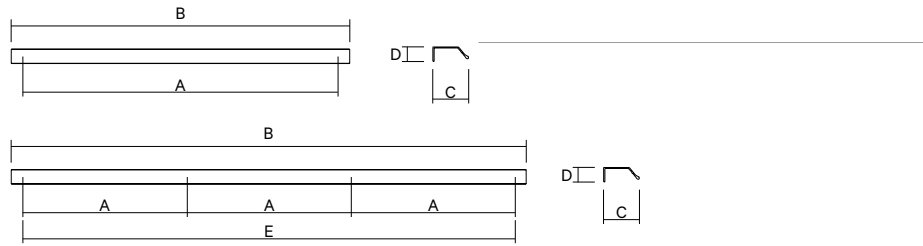

Acabado / Finition / Finish / Oberfläche

		
<b>220</b> Oro cepillado anodizado Or brossé anodisé Brushed gold anodized Goldfarben gebürstet eloxiert	<b>232</b> Negro mate anodizado Noir mat anodisé Dull black anodized Schwarz matt eloxiert	<b>238</b> Níquel cepillado anodizado Nickelé brossé anodisé Brushed nickel anodized Vernickelt gebürstet eloxiert



**Flat**

Aluminio / Aluminium / Aluminium / Aluminium

	A	B	B	C	D
6611	3 x 352	1056	1110	40	17
6612	320		400	40	17
6613	192		250	40	17
6614	32		50	40	17

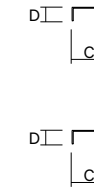
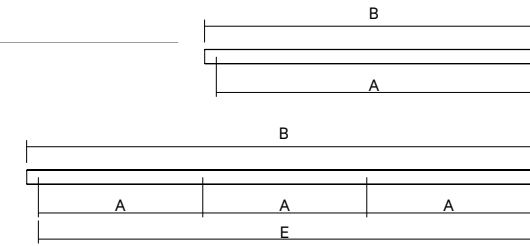

Acabado / Finition / Finish / Oberfläche

		
<b>220</b> Oro cepillado anodizado Or brossé anodisé Brushed gold anodized Goldfarben gebürstet eloxiert	<b>232</b> Negro mate anodizado Noir mat anodisé Dull black anodized Schwarz matt eloxiert	<b>238</b> Níquel cepillado anodizado Nickelé brossé anodisé Brushed nickel anodized Vernickelt gebürstet eloxiert



**Mesh**

Aluminio / Aluminium / Aluminium / Aluminium

	B	D	E
8891	36	28	20
8892	26	23	12

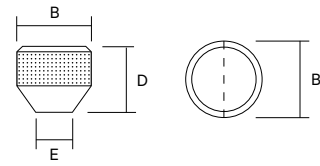

**Mesh**

Aluminio / Aluminium / Aluminium / Aluminium

	A	B	C	D
6891	320	332	12	29,5
6892	192	204	12	29,5
6893	160	172	12	29,5

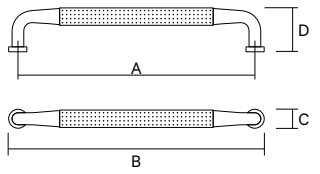

Acabado / Finition / Finish / Oberfläche



220

Oro cepillado anodizado  
Or brossé anodisé  
Brushed gold anodized  
Goldfarben gebürstet eloxiert



232

Negro mate anodizado  
Noir mat anodisé  
Dull black anodized  
Schwarz matt eloxiert



238

Níquel cepillado anodizado  
Nickelé brossé anodisé  
Brushed nickel anodized  
Vernickelt gebürstet eloxiert

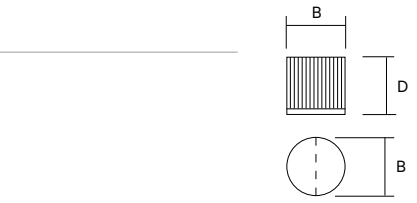

**Grooves**

Zamak

	B	D
8181	28	30
8182	18	28

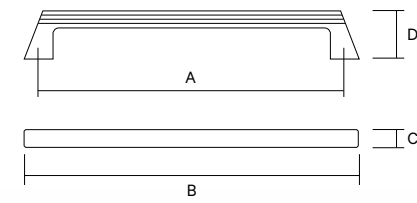

**Grooves**

Zamak

	A	B	C	D
6871	320	338	9	30
6872	192	210	9	30
6873	128	146	9	30

Acabado / Finition / Finish / Oberfläche



020

Oro cepillado  
Or brossé  
Brushed Gold  
Gebürstetes Gold



032

Negro mate  
Noir mat  
Dull black  
Mattschwarz



038

Níquel cepillado  
Nickelé brossé  
Brushed Nickel  
Gebürstetes Nickel



400

Cromo brillo  
Chromé brillant  
Bright chrome  
Glänzend verchromt

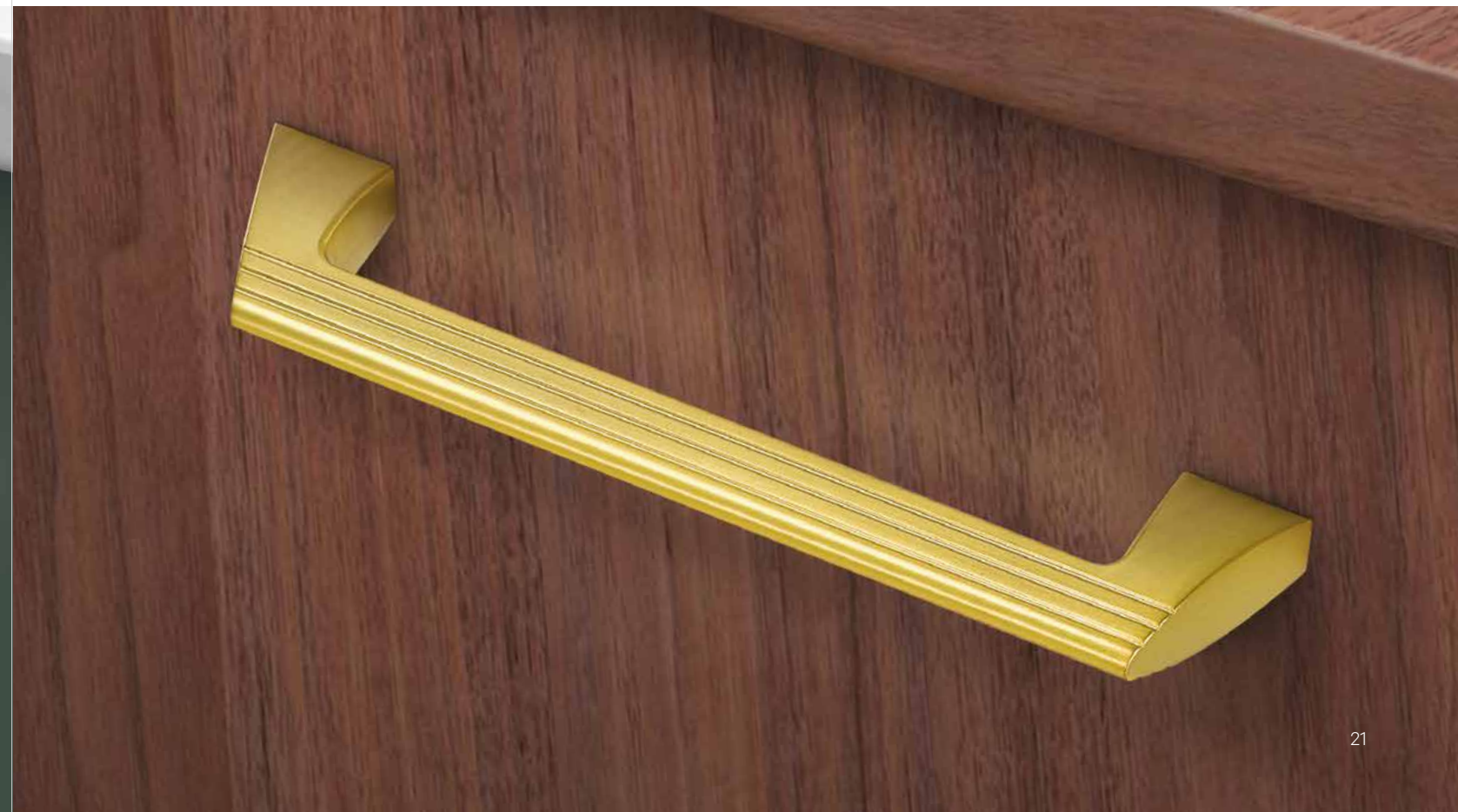



**Disc**

Zamak

	B	D	E
8341	33	25	15
8342	28	23	18

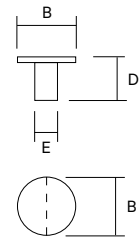

**Right**

Zamak

	A	B	C	D
6841	320	360	8	28
6842	192	232	8	28
6843	128	168	8	28

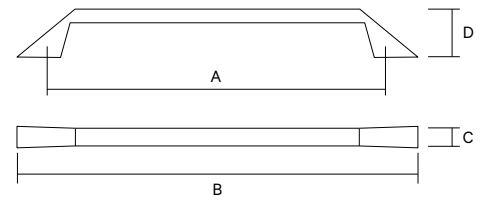

Acabado / Finition / Finish / Oberfläche

<b>020</b> Oro cepillado Or brossé Brushed Gold Gebürstetes Gold	<b>032</b> Negro mate Noir mat Dull black Mattschwarz	<b>038</b> Níquel cepillado Nickelé brossé Brushed Nickel Gebürstetes Nickel

<b>292</b> Blanco mate Blanc mat Dull white Matt Weiß





**Wedge**

Zamak

	A	B	C	D
6851	320	338	18	28
6852	192	210	18	28
6853	128	146	18	28

Acabado / Finition / Finish / Oberfläche



**020**  
Oro cepillado  
Or brossé  
Brushed Gold  
Gebürstetes Gold



**032**  
Negro mate  
Noir mat  
Dull black  
Mattschwarz



**038**  
Níquel cepillado  
Nickelé brossé  
Brushed Nickel  
Gebürstetes Nickel



**292**  
Blanco mate  
Blanc mat  
Dull white  
Matt Weiß

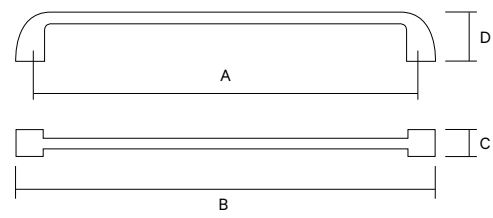



**Swing**

Zamak				
	<b>B</b>	<b>C</b>	<b>D</b>	
<b>6242</b>	55	44	24	

Acabado / Finition / Finish / Oberfläche

		
<b>020</b> Oro cepillado Or brossé Brushed Gold Gebürstetes Gold	<b>038</b> Níquel cepillado Nickelé brossé Brushed Nickel Gebürstetes Nickel	<b>831</b> Bronce rústico Bronze rustique Antique brass Bronze rustikal

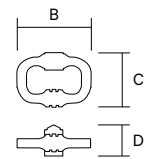

**Swing**

Zamak				
	<b>A</b>	<b>B</b>	<b>C</b>	<b>D</b>
<b>6241</b>	64	120	44	24

Acabado / Finition / Finish / Oberfläche

		
<b>020</b> Oro cepillado Or brossé Brushed Gold Gebürstetes Gold	<b>038</b> Níquel cepillado Nickelé brossé Brushed Nickel Gebürstetes Nickel	<b>831</b> Bronce rústico Bronze rustique Antique brass Bronze rustikal

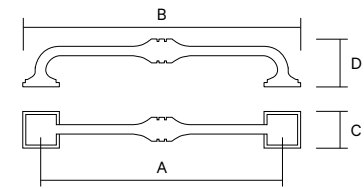
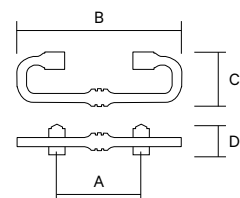

**Swing**

Zamak				
	<b>A</b>	<b>B</b>	<b>C</b>	<b>D</b>
<b>6240</b>	160	184	24	34

Acabado / Finition / Finish / Oberfläche

		
<b>020</b> Oro cepillado Or brossé Brushed Gold Gebürstetes Gold	<b>038</b> Níquel cepillado Nickelé brossé Brushed Nickel Gebürstetes Nickel	<b>831</b> Bronce rústico Bronze rustique Antique brass Bronze rustikal





### Spheres

Zamak

	B	C	D
6860	46	14	30

### Spheres

Zamak

	A	B	C	D
6861	192	238	14	30
6862	128	174	14	30
6863	96	142	14	30

Acabado / Finition / Finish / Oberfläche



**020**  
Oro cepillado  
Or brossé  
Brushed Gold  
Gebürstetes Gold



**032**  
Negro mate  
Noir mat  
Dull black  
Mattschwarz



**038**  
Níquel cepillado  
Nickelé brossé  
Brushed Nickel  
Gebürstetes Nickel



**831**  
Bronze rústico  
Bronze rustique  
Antique brass  
Bronze rustikal

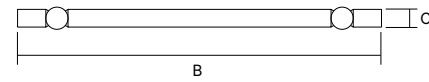
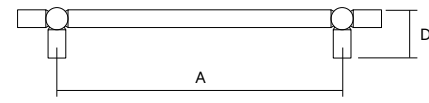
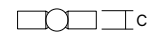
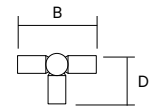



**Shell**

Zamak	A	B	C	D
3961	64	101	26	29

Acabado / Finition / Finish / Oberfläche

<b>020</b> Oro cepillado Or brossé Brushed Gold Gebürstetes Gold	<b>032</b> Negro mate Noir mat Dull black Mattschwarz	<b>038</b> Níquel cepillado Nickelé brossé Brushed Nickel Gebürstetes Nickel
<b>400</b> Cromo brillo Chromé brillant Bright chrome Glänzend verchromt		

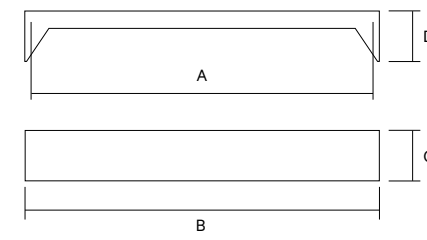
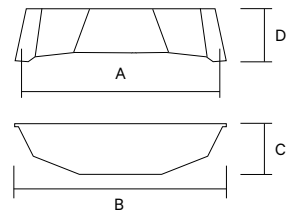

**Post**

Zamak	A	B	C	D
6831	192	213	31	20
6832	128	149	31	20

Acabado / Finition / Finish / Oberfläche

<b>020</b> Oro cepillado Or brossé Brushed Gold Gebürstetes Gold	<b>032</b> Negro mate Noir mat Dull black Mattschwarz	<b>038</b> Níquel cepillado Nickelé brossé Brushed Nickel Gebürstetes Nickel
<b>250</b> Oro mate Or mat Dull gold Matt Gold	<b>292</b> Blanco mate Blanc mat Dull white Matt Weiß	<b>400</b> Cromo brillo Chromé brillant Bright chrome Glänzend verchromt
<b>750</b> Grafito Graphite Graphite Graphit	<b>800</b> Cromo mate Chromé mat Dull chrome Matt verchromt	











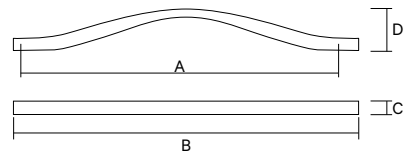

**Fluid**

Zamak

	A	B	C	D
6821	320/288	363	7,60/12,80	33,80
6822	224/192	263	7,60/12,80	28,80



Acabado / Finition / Finish / Oberfläche

			
<b>020</b> Oro cepillado Or brossé Brushed Gold Gebürstetes Gold	<b>032</b> Negro mate Noir mat Dull black Mattschwarz	<b>038</b> Níquel cepillado Nickelé brossé Brushed Nickel Gebürstetes Nickel	<b>250</b> Oro mate Or mat Dull gold Matt Gold
			
<b>292</b> Blanco mate Blanc mat Dull white Matt Weiß	<b>400</b> Cromo brillo Chromé brillant Bright chrome Glänzend verchromt	<b>750</b> Grafito Graphite Graphite Graphit	<b>800</b> Cromo mate Chromé mat Dull chrome Matt verchromt





**Round**

Zamak	D	E	F
3760	70	45	11

Acabado / Finition / Finish / Oberfläche

<b>032</b> Negro mate Noir mat Dull black Mattschwarz	<b>038</b> Níquel cepillado Nickelé brossé Brushed Nickel Gebürstetes Nickel	<b>292</b> Blanco mate Blanc mat Dull white Matt Weiß

<b>400</b> Cromo brillo Chromé brillant Bright chrome Glänzend verchromt

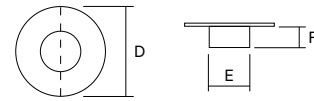

**Square**

Zamak	B	C	E	F
3770	73	73	45	11

Acabado / Finition / Finish / Oberfläche

<b>032</b> Negro mate Noir mat Dull black Mattschwarz	<b>038</b> Níquel cepillado Nickelé brossé Brushed Nickel Gebürstetes Nickel	<b>292</b> Blanco mate Blanc mat Dull white Matt Weiß

<b>400</b> Cromo brillo Chromé brillant Bright chrome Glänzend verchromt

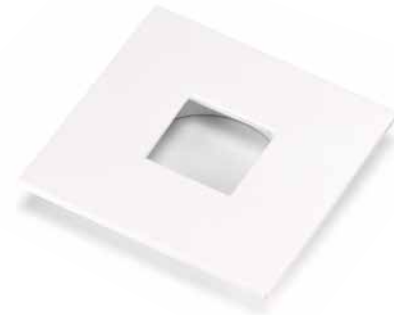
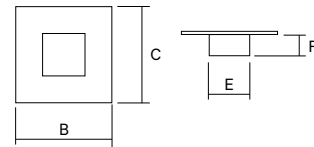

**Oval**

Zamak	B	C	E	F
3780	155	70	40x123	11

Acabado / Finition / Finish / Oberfläche

<b>032</b> Negro mate Noir mat Dull black Mattschwarz	<b>038</b> Níquel cepillado Nickelé brossé Brushed Nickel Gebürstetes Nickel	<b>292</b> Blanco mate Blanc mat Dull white Matt Weiß

<b>400</b> Cromo brillo Chromé brillant Bright chrome Glänzend verchromt

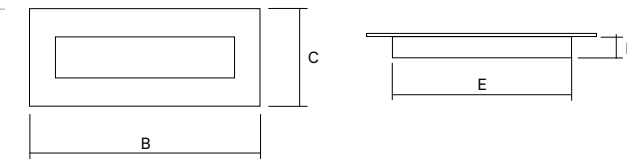
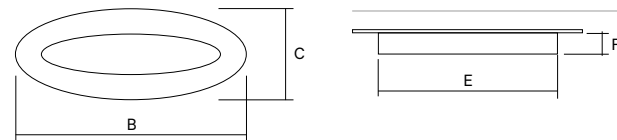

**Rectangular**

Zamak	B	C	E	F
3790	155	73	40x123	11

Acabado / Finition / Finish / Oberfläche

<b>032</b> Negro mate Noir mat Dull black Mattschwarz	<b>038</b> Níquel cepillado Nickelé brossé Brushed Nickel Gebürstetes Nickel	<b>292</b> Blanco mate Blanc mat Dull white Matt Weiß

<b>400</b> Cromo brillo Chromé brillant Bright chrome Glänzend verchromt



**Elbow**

Zamak	A	B	C	D
6231	192	208	20	30
6232	128	144	20	30

Acabado / Finition / Finish / Oberfläche

<b>032</b> Negro mate Noir mat Dull black Mattschwarz	<b>038</b> Níquel cepillado Nickelé brossé Brushed Nickel Gebürstetes Nickel	<b>292</b> Blanco mate Blanc mat Dull white Matt Weiß

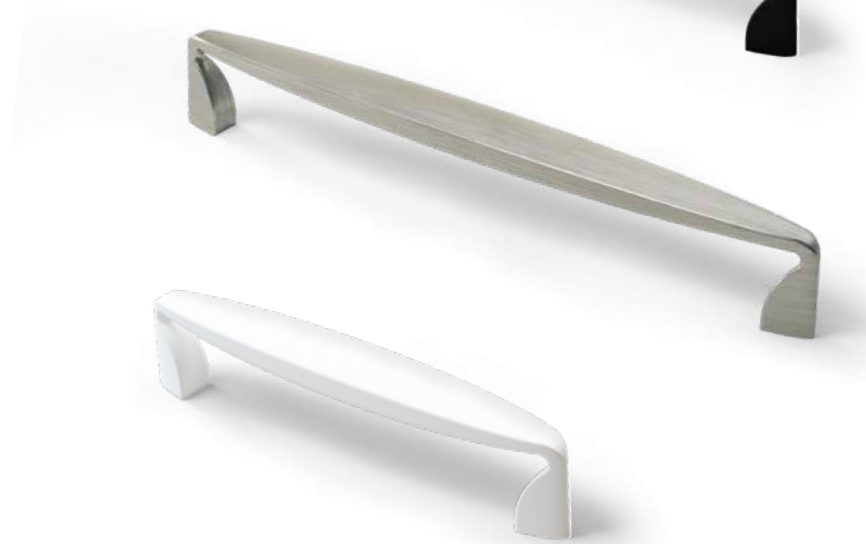
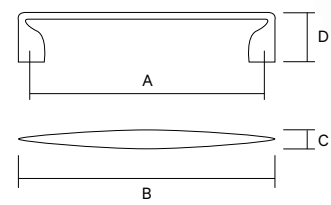

**Scoop**

Zamak	A	B	C	D
6801	224	320	45,5	18
6802	160	240	45,5	18
6803	32	72	45,5	18

Acabado / Finition / Finish / Oberfläche

<b>038</b> Níquel cepillado Nickelé brossé Brushed Nickel Gebürstetes Nickel	<b>400</b> Cromo brillo Chromé brillant Bright chrome Glänzend verchromt	<b>800</b> Cromo mate Chromé mat Dull chrome Matt verchromt

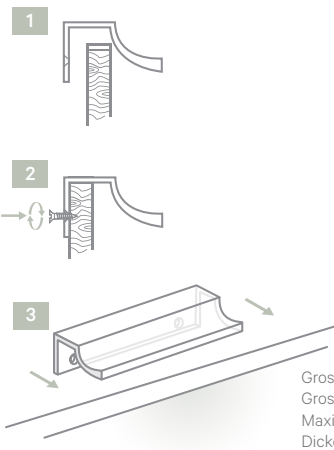
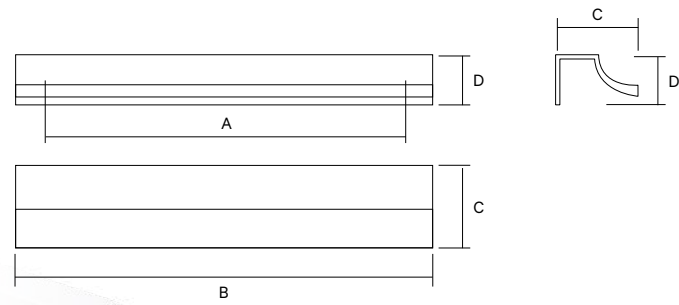

Grossor máximo frontal cajón: 22 mm  
Grosueur maximale frontal tirair: 22 mm  
Maximum width drawer front: 22 mm  
Dicke maximal front schublade: 22 mm

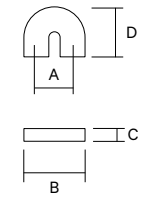

**Circle**

Zamak	A	B	C	D
6100	32	40	11	28

Acabado / Finition / Finish / Oberfläche

<b>032</b> Negro mate Noir mat Dull black Mattschwarz	<b>038</b> Níquel cepillado Nickelé brossé Brushed Nickel Gebürstetes Nickel	<b>292</b> Blanco mate Blanc mat Dull white Matt Weiß
<b>400</b> Cromo brillo Chromé brillant Bright chrome Glänzend verchromt	<b>800</b> Cromo mate Chromé mat Dull chrome Matt verchromt	

**Circle**

Zamak	A	B	C	D
6111	32	40	8	40
6112		25	8	27

Acabado / Finition / Finish / Oberfläche

<b>032</b> Negro mate Noir mat Dull black Mattschwarz	<b>038</b> Níquel cepillado Nickelé brossé Brushed Nickel Gebürstetes Nickel	<b>292</b> Blanco mate Blanc mat Dull white Matt Weiß
<b>400</b> Cromo brillo Chromé brillant Bright chrome Glänzend verchromt	<b>800</b> Cromo mate Chromé mat Dull chrome Matt verchromt	

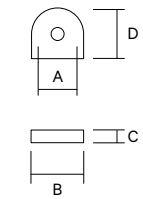



**Flexo**

Zamak				
	A	B	C	D
6191	160	186	24	29

Acabado / Finition / Finish / Oberfläche



**811**  
Bronce Industrial  
Bronze industriel  
Industrial Bronze  
Bronze industriell



**812**  
Hierro Industrial  
Fer industriel  
Industrial Iron  
Eisen industriell

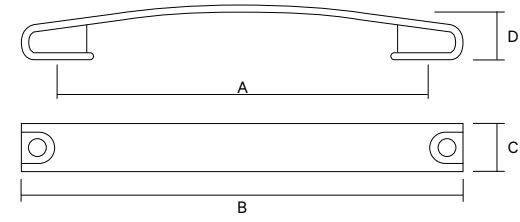

**Flexo**

Zamak			
	B	C	D
6190	49	24	25

Acabado / Finition / Finish / Oberfläche



**811**  
Bronce Industrial  
Bronze industriel  
Industrial Bronze  
Bronze industriell



**812**  
Hierro Industrial  
Fer industriel  
Industrial Iron  
Eisen industriell

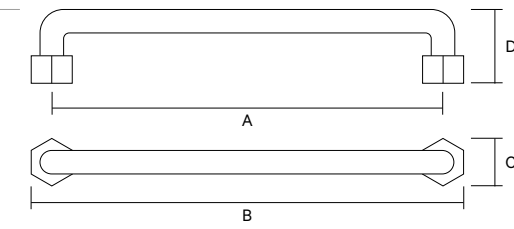
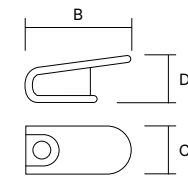

**Tube**

Zamak				
	A	B	C	D
6201	192	212	14	34

Acabado / Finition / Finish / Oberfläche



**831**  
Bronce rústico  
Bronze rustique  
Antique brass  
Bronze rustikal



**836**  
Estaño rústico  
Etain rustique  
Rustic tin  
Zinn rustikal

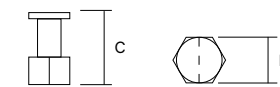

**Tube**

Zamak		
	C	D
6200	33	19

Acabado / Finition / Finish / Oberfläche



**831**  
Bronce rústico  
Bronze rustique  
Antique brass  
Bronze rustikal



**836**  
Estaño rústico  
Etain rustique  
Rustic tin  
Zinn rustikal

**Rivet**

Zamak	A	B	C	D
6211	160	186	22	28

Acabado / Finition / Finish / Oberfläche

- 811**  
Bronze Industrial  
Bronze industriel  
Industrial Bronze  
Bronze industriell
- 812**  
Hierro Industrial  
Fer industriel  
Industrial Iron  
Eisen industriell

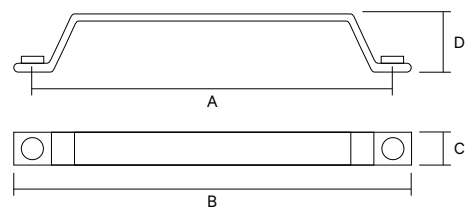

**Rivet**

Zamak	B	C	D
6210	56	20	30

Acabado / Finition / Finish / Oberfläche

- 811**  
Bronze Industrial  
Bronze industriel  
Industrial Bronze  
Bronze industriell
- 812**  
Hierro Industrial  
Fer industriel  
Industrial Iron  
Eisen industriell

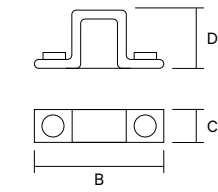

**Arch**

Zamak	A	B	C	D
6791	192	270	20	20
6792	128	206	20	20

Acabado / Finition / Finish / Oberfläche

- 032**  
Negro mate  
Noir mat  
Dull black  
Mattschwarz
- 038**  
Níquel cepillado  
Nickelé brossé  
Brushed Nickel  
Gebürstetes Nickel
- 292**  
Blanco mate  
Blanc mat  
Dull white  
Matt Weiß

- 800**  
Cromo mate  
Chromé mat  
Dull chrome  
Matt verchromt

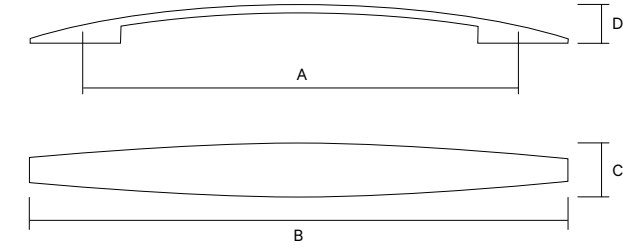



**Fuji**

Zamak

	A	B	C	D
6811	224	320	20	32
6812	160	230	20	32

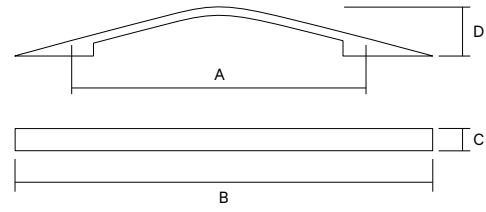

Acabado / Finition / Finish / Oberfläche

<b>020</b> Oro cepillado Or brossé Brushed Gold Gebürstetes Gold	<b>032</b> Negro mate Noir mat Dull black Mattschwarz	<b>038</b> Níquel cepillado Nickelé brossé Brushed Nickel Gebürstetes Nickel	<b>250</b> Oro mate Or mat Dull gold Matt Gold	<b>292</b> Blanco mate Blanc mat Dull white Matt Weiß	<b>400</b> Cromo brillo Chromé brillant Bright chrome Glänzend verchromt
<b>750</b> Grafito Graphite Graphite Graphit	<b>800</b> Cromo mate Chromé mat Dull chrome Matt verchromt	<b>808</b> Cobre rústico Cuivre rustique Rustic copper Kupfer rustikal	<b>831</b> Bronce rústico Bronze rustique Antique brass Bronze rustikal	<b>836</b> Estaño rústico Etain rustique Rustic tin Zinn rustikal	













**Lips**

Zamak	A	B	C	D
6781	224	320	45	21
6782	160	240	45	21

Acabado / Finition / Finish / Oberfläche

 <b>032</b> Negro mate Noir mat Dull black Mattschwarz	 <b>038</b> Níquel cepillado Nickelé brossé Brushed Nickel Gebürstetes Nickel	 <b>292</b> Blanco mate Blanc mat Dull white Matt Weiß
 <b>400</b> Cromo brillo Chromé brillant Bright chrome Glänzend verchromt	 <b>800</b> Cromo mate Chromé mat Dull chrome Matt verchromt	 <b>808</b> Cobre rústico Cuivre rustique Rustic copper Kupfer rustikal
 <b>831</b> Bronce rústico Bronze rustique Antique brass Bronze rustikal	 <b>836</b> Estaño rústico Etain rustique Rustic tin Zinn rustikal	

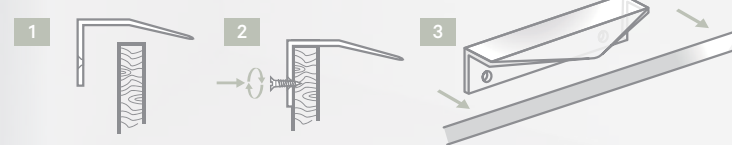
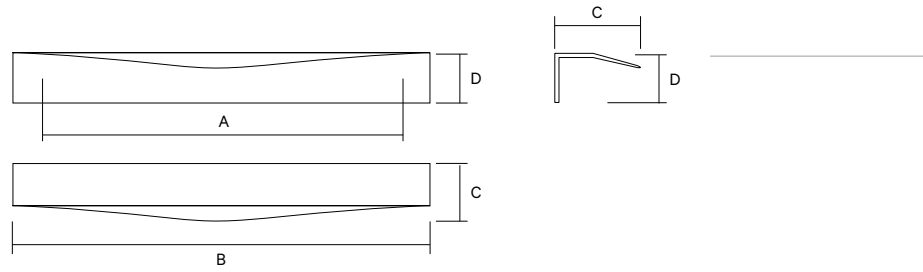

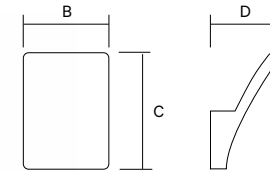

Grossor máximo frontal cajón: 24,5 mm  
Grosueur maximale frontal tirair: 24,5 mm  
Maximum width drawer front: 24,5 mm  
Dicke maximal front schublade: 24,5 mm



**Slide**

Zamak	B	C	D
2840	44	54	37

Acabado / Finition / Finish / Oberfläche

 <b>038</b> Níquel cepillado Nickelé brossé Brushed Nickel Gebürstetes Nickel	 <b>400</b> Cromo brillo Chromé brillant Bright chrome Glänzend verchromt	 <b>800</b> Cromo mate Chromé mat Dull chrome Matt verchromt
---	---	--

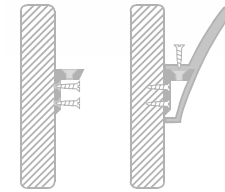

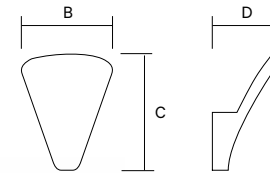

Los colgadores individuales poseen una efectiva y fácil manera de fijación.  
Les portemanteaux individuels incorporent un système de fixation simple et efficace.  
Individual hangers grant an easy and effective fixing system.  
Die Einzelkleiderhaken verfügen über ein einfaches und wirksames Befestigungssystem.



**Slide**

Zamak	B	C	D
2850	49	55	37

Acabado / Finition / Finish / Oberfläche

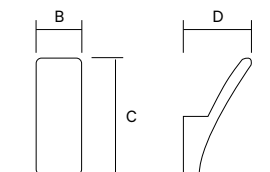

 <b>038</b> Níquel cepillado Nickelé brossé Brushed Nickel Gebürstetes Nickel	 <b>400</b> Cromo brillo Chromé brillant Bright chrome Glänzend verchromt	 <b>800</b> Cromo mate Chromé mat Dull chrome Matt verchromt
--	--	---



**Slide**

Zamak	B	C	D
2860	25	56	30

Acabado / Finition / Finish / Oberfläche

 <b>038</b> Níquel cepillado Nickelé brossé Brushed Nickel Gebürstetes Nickel	 <b>400</b> Cromo brillo Chromé brillant Bright chrome Glänzend verchromt	 <b>800</b> Cromo mate Chromé mat Dull chrome Matt verchromt
---	---	--





**Mini**

Zamak

	B	C	D
8151	25	25	28
8152	15	15	24

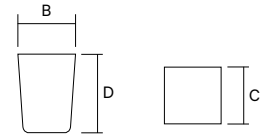

Acabado / Finition / Finish / Oberfläche



<b>020</b> Oro cepillado Or brossé Brushed Gold Gebürstetes Gold	<b>021</b> Aluminio Aluminium Aluminium Aluminium	<b>038</b> Niquel cepillado Nickelé brossé Brushed Nickel Gebürstetes Nickel	<b>250</b> Oro mate Or mat Dull gold Matt Gold
--	---	--	--



<b>400</b> Cromo brillo Chromé brillant Bright chrome Glänzend verchromt	<b>750</b> Grafito Graphite Graphite Graphit	<b>800</b> Cromo mate Chromé mat Dull chrome Matt verchromt
--	--	---

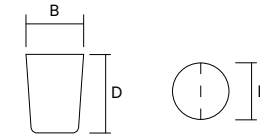

**Mini**

Zamak

	B	D
8161	25	28
8162	15	24

Acabado / Finition / Finish / Oberfläche



<b>020</b> Oro cepillado Or brossé Brushed Gold Gebürstetes Gold	<b>021</b> Aluminio Aluminium Aluminium Aluminium	<b>032</b> Negro mate Noir mat Dull black Mattschwarz
--	---	---



<b>038</b> Niquel cepillado Nickelé brossé Brushed Nickel Gebürstetes Nickel	<b>250</b> Oro mate Or mat Dull gold Matt Gold	<b>800</b> Cromo mate Chromé mat Dull chrome Matt verchromt
--	--	---



<b>292</b> Blanco mate Blanc mat Dull white Matt Weiß	<b>400</b> Cromo brillo Chromé brillant Bright chrome Glänzend verchromt	<b>750</b> Grafito Graphite Graphite Graphit
---	--	--



<b>800</b> Cromo mate Chromé mat Dull chrome Matt verchromt
---

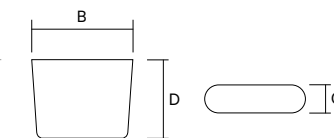

**Mini**

Zamak

	B	C	D
8171	34	14	28
8172	27	11	24

Acabado / Finition / Finish / Oberfläche



<b>021</b> Aluminio Aluminium Aluminium Aluminium	<b>032</b> Negro mate Noir mat Dull black Mattschwarz	<b>038</b> Niquel cepillado Nickelé brossé Brushed Nickel Gebürstetes Nickel
---	---	--



<b>292</b> Blanco mate Blanc mat Dull white Matt Weiß	<b>400</b> Cromo brillo Chromé brillant Bright chrome Glänzend verchromt	<b>800</b> Cromo mate Chromé mat Dull chrome Matt verchromt
---	--	---

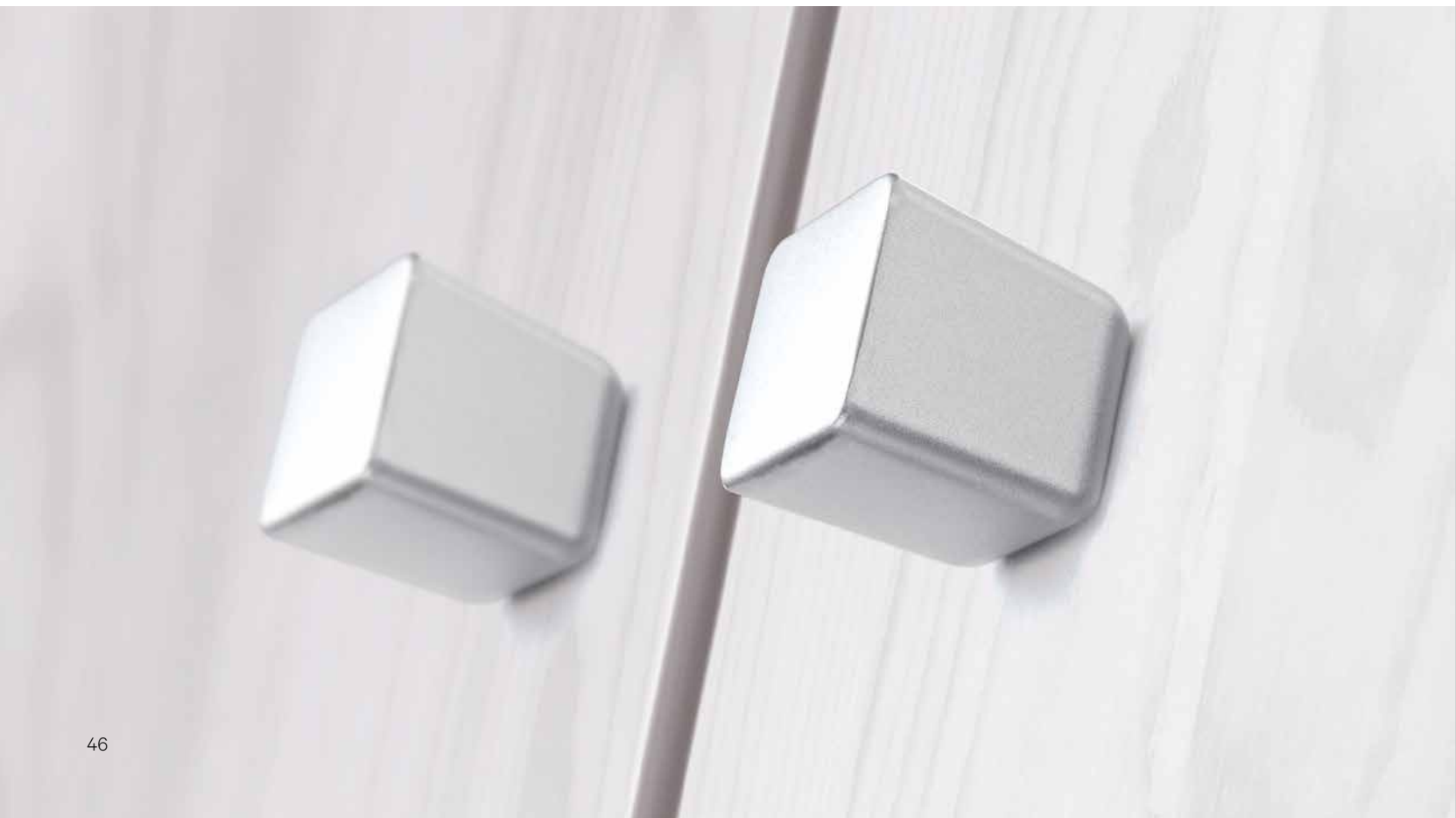

**Profit**

Zamak	A	B	C	D
1801	288/320	341	10	31
1802	192/224	245	10	31
1803	128/160	180	10	31

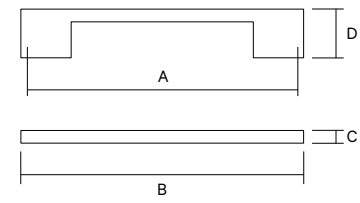

Acabado / Finition / Finish / Oberfläche

- |  |   |
|--|---|
|  |  |
| <b>038</b>   | <b>800</b>  |
| Níquel cepillado<br>Nickelé brossé<br>Brushed Nickel<br>Gebürstetes Nickel       | Cromo mate<br>Chromé mat<br>Dull chrome<br>Matt verchromt                         |

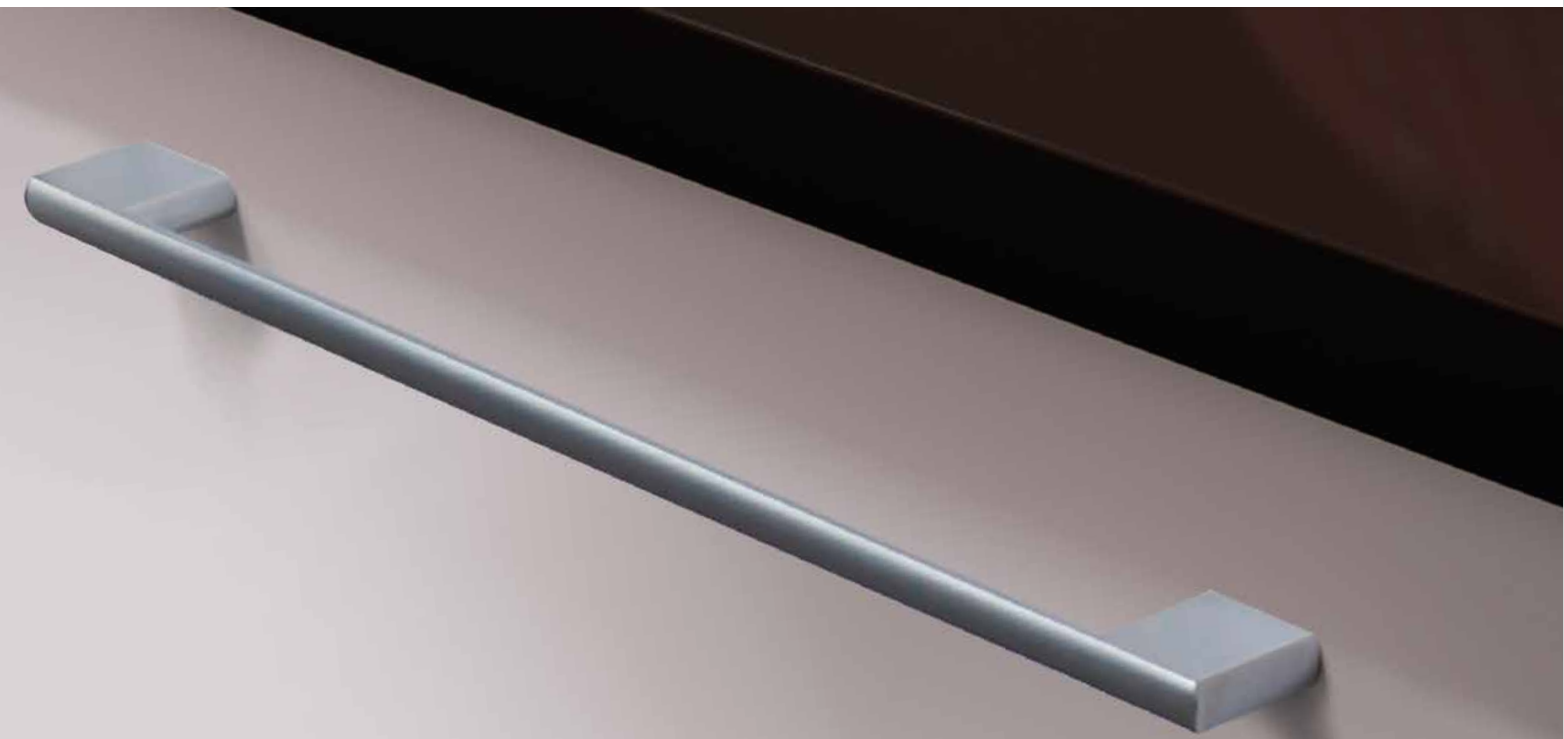

**Proflex**

Zamak	A	B	C	D
1810	192/224	247	26/10	32

Acabado / Finition / Finish / Oberfläche

- |   |   |
|---|---|
|  |  |
| <b>038</b>  | <b>800</b>  |
| Níquel cepillado<br>Nickelé brossé<br>Brushed Nickel<br>Gebürstetes Nickel          | Cromo mate<br>Chromé mat<br>Dull chrome<br>Matt verchromt                           |

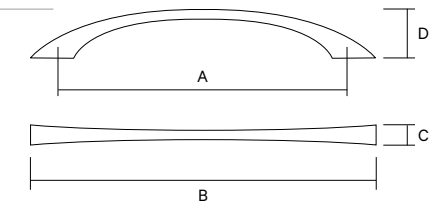

**ProFlat**

Zamak	A	B	C	D
1820	192/224	247	24/10	32

Acabado / Finition / Finish / Oberfläche

- |   |   |
|---|---|
|  |  |
| <b>038</b>  | <b>800</b>  |
| Níquel cepillado<br>Nickelé brossé<br>Brushed Nickel<br>Gebürstetes Nickel          | Cromo mate<br>Chromé mat<br>Dull chrome<br>Matt verchromt                           |

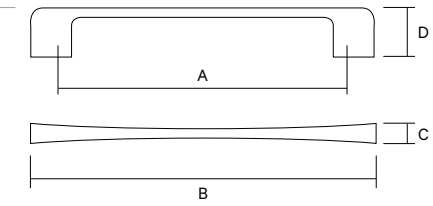

**ProFab**

Zamak	A	B	C	D
1830	192/224	247	20/11	31

Acabado / Finition / Finish / Oberfläche

- |   |   |
|---|---|
|  |  |
| <b>038</b>  | <b>800</b>  |
| Níquel cepillado<br>Nickelé brossé<br>Brushed Nickel<br>Gebürstetes Nickel            | Cromo mate<br>Chromé mat<br>Dull chrome<br>Matt verchromt                             |

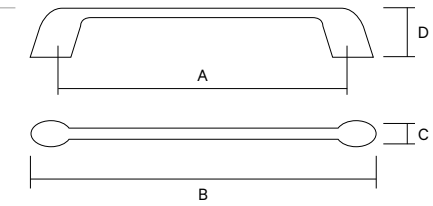



**Basic**

Zamak

	A	B	C	D
6761	320	328	8	28
6762	256	264	8	28
6763	192	200	8	28
6764	160	168	8	28
6765	128	136	8	28

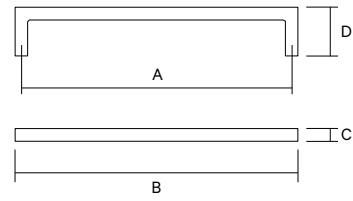

Acabado / Finition / Finish / Oberfläche

<b>020</b> Oro cepillado Or brossé Brushed Gold Gebürstetes Gold	<b>032</b> Negro mate Noir mat Dull black Mattschwarz	<b>038</b> Níquel cepillado Nickelé brossé Brushed Nickel Gebürstetes Nickel	<b>250</b> Oro mate Or mat Dull gold Matt Gold	<b>292</b> Blanco mate Blanc mat Dull white Matt Weiß
<b>750</b> Grafito Graphite Graphit	<b>800</b> Cromo mate Chromé mat Dull chrome Matt verchromt	<b>808</b> Cobre rústico Cuivre rustique Rustic copper Kupfer rustikal	<b>831</b> Bronce rústico Bronze rustique Antique brass Bronze rustikal	<b>836</b> Estaño rústico Etain rustique Rustic tin Zinn rustikal



**I-Spazio**

Zamak	A	B	C	D	E	F	G
7570	192	260	8	32	22	108	130

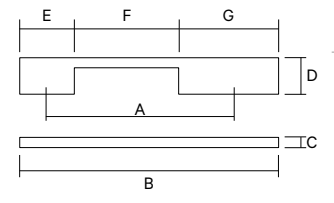

Acabado / Finition / Finish / Oberfläche

<b>021</b> Aluminio Aluminium Aluminium Aluminium	<b>032</b> Negro mate Noir mat Dull black Mattschwarz	<b>038</b> Níquel cepillado Nickelé brossé Brushed Nickel Gebürstetes Nickel
<b>292</b> Blanco mate Blanc mat Dull white Matt Weiß	<b>400</b> Cromo brillo Chromé brillant Bright chrome Glänzend verchromt	<b>800</b> Cromo mate Chromé mat Dull chrome Matt verchromt



**I-Spazio**

Zamak	A	B	C	D	E	F	G
7571	192	260	8	32	76	108	76
7572	128	200	8	32	56	88	56

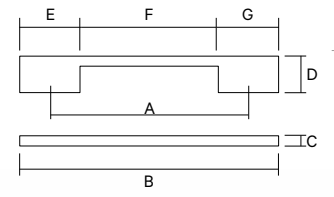

Acabado / Finition / Finish / Oberfläche

<b>021</b> Aluminio Aluminium Aluminium Aluminium	<b>032</b> Negro mate Noir mat Dull black Mattschwarz	<b>038</b> Níquel cepillado Nickelé brossé Brushed Nickel Gebürstetes Nickel
<b>292</b> Blanco mate Blanc mat Dull white Matt Weiß	<b>400</b> Cromo brillo Chromé brillant Bright chrome Glänzend verchromt	<b>800</b> Cromo mate Chromé mat Dull chrome Matt verchromt

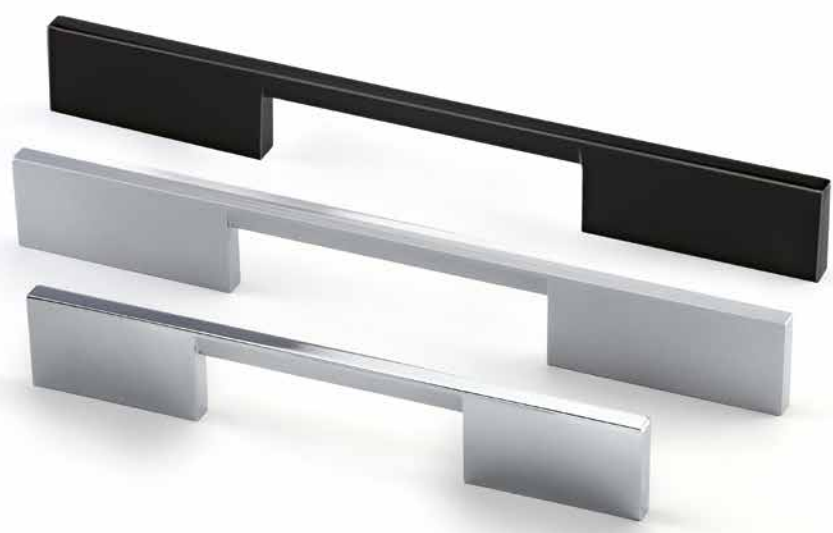

**Edge**

Zamak	A	B	C	D
7531	160	188	9	35
7532	96	124	8	30

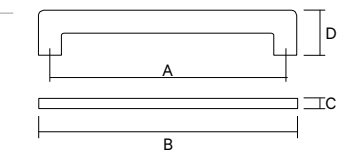

Acabado / Finition / Finish / Oberfläche

<b>021</b> Aluminio Aluminium Aluminium Aluminium	<b>038</b> Níquel cepillado Nickelé brossé Brushed Nickel Gebürstetes Nickel	<b>400</b> Cromo brillo Chromé brillant Bright chrome Glänzend verchromt	<b>800</b> Cromo mate Chromé mat Dull chrome Matt verchromt



**Jazz**

Zamak	A	B	C	D
7751	160	204	25	29

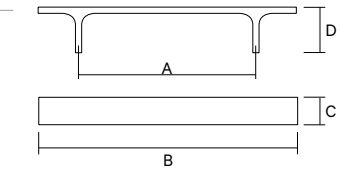

Acabado / Finition / Finish / Oberfläche

<b>021</b> Aluminio Aluminium Aluminium Aluminium	<b>038</b> Níquel cepillado Nickelé brossé Brushed Nickel Gebürstetes Nickel	<b>400</b> Cromo brillo Chromé brillant Bright chrome Glänzend verchromt	<b>800</b> Cromo mate Chromé mat Dull chrome Matt verchromt





**Dual**

Zamak	A	B	C	D
7691	192	201	10	26
7692	160	169	10	26
7693	128	137	10	26

Acabado / Finition / Finish / Oberfläche

		
<b>038</b> Níquel cepillado Nickelé brossé Brushed Nickel Gebürstetes Nickel	<b>400</b> Cromo brillo Chromé brillant Bright chrome Glänzend verchromt	<b>800</b> Cromo mate Chromé mat Dull chrome Matt verchromt

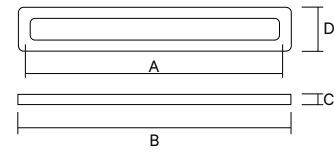

**Dual**

Zamak	A	B	C	D
7694	16	26	10	26

Acabado / Finition / Finish / Oberfläche

		
<b>038</b> Níquel cepillado Nickelé brossé Brushed Nickel Gebürstetes Nickel	<b>400</b> Cromo brillo Chromé brillant Bright chrome Glänzend verchromt	<b>800</b> Cromo mate Chromé mat Dull chrome Matt verchromt

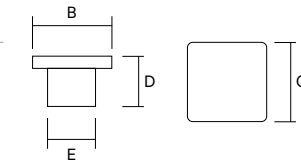
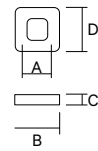

**Wave**

Zamak	B	C	D	E
8101	80	80	24	18
8102	50	50	24	16
8103	32	32	24	12

Acabado / Finition / Finish / Oberfläche

			
<b>021</b> Aluminio Aluminium Aluminium	<b>038</b> Níquel cepillado Nickelé brossé Brushed Nickel Gebürstetes Nickel	<b>400</b> Cromo brillo Chromé brillant Bright chrome Glänzend verchromt	<b>800</b> Cromo mate Chromé mat Dull chrome Matt verchromt

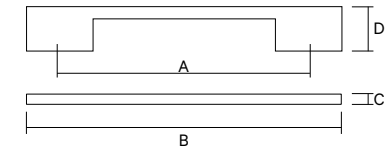

**Align**

Zamak	A	B	C	D
7541	224	252	9	20
7542	192	208	9	20
7543	128	157	9	20

Acabado / Finition / Finish / Oberfläche

			
<b>021</b> Aluminio Aluminium Aluminium	<b>038</b> Níquel cepillado Nickelé brossé Brushed Nickel Gebürstetes Nickel	<b>400</b> Cromo brillo Chromé brillant Bright chrome Glänzend verchromt	<b>800</b> Cromo mate Chromé mat Dull chrome Matt verchromt



**Synthesis**

Zamak	A	B	C	D
7661	192	230	44	24
7662	96	135	44	24
7663	32	71	44	24

Acabado / Finition / Finish / Oberfläche

<b>021</b> Aluminio Aluminium Aluminium Aluminium	<b>032</b> Negro mate Noir mat Dull black Mattschwarz	<b>038</b> Níquel cepillado Nickelé brossé Brushed Nickel Gebürstetes Nickel
<b>292</b> Blanco mate Blanc mat Dull white Matt Weiß	<b>400</b> Cromo brillo Chromé brillant Bright chrome Glänzend verchromt	<b>800</b> Cromo mate Chromé mat Dull chrome Matt verchromt
<b>808</b> Cobre rústico Cuivre rustique Rustic copper Kupfer rustikal	<b>831</b> Bronze rústico Bronze rustique Antique brass Bronze rustikal	<b>836</b> Estaño rústico Etain rustique Rustic tin Zinn rustikal

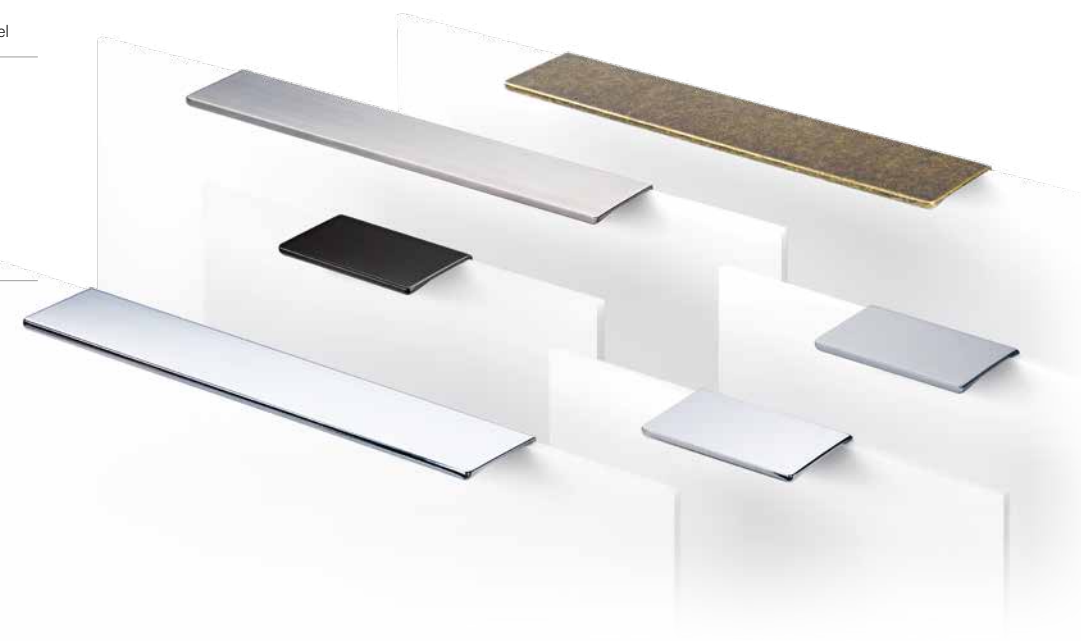
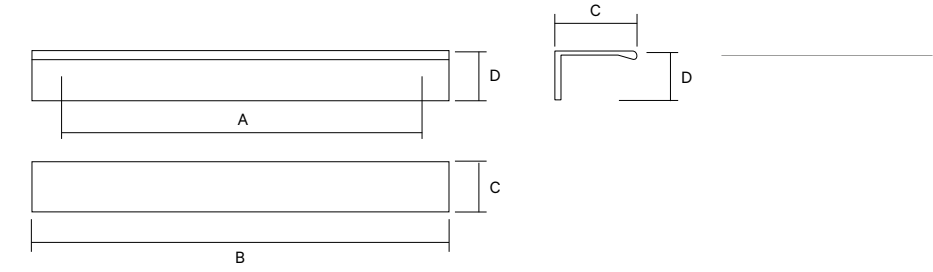

**Symbiosis**

Zamak	A	B	C	D	E
9381	192	208	12	29	16
9382	160	176	12	29	16
9383	128	144	12	29	16

Acabado / Finition / Finish / Oberfläche

<b>800</b> Cromo mate/Fresno, barniz wengue Chromé mat/Frêne, vernis wengué Dull chrome/Ash tree, wengue varnish Matt verchromt/Esche, Wenge lackiert	<b>815</b> Cromo mate/Haya, barniz transparente Chromé mat/Hêtre, vernis transparent Dull chrome/Beech, transparent varnish Chrom matt/Buche, transparentlackiert

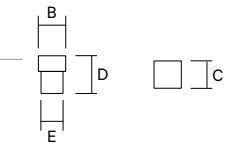
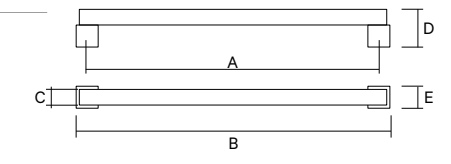

**Symbiosis**

Zamak	B	C	D	E
9090	21	21	29	16

Acabado / Finition / Finish / Oberfläche

<b>800</b> Cromo mate/Fresno, barniz wengue Chromé mat/Frêne, vernis wengué Dull chrome/Ash tree, wengue varnish Matt verchromt/Esche, Wenge lackiert	<b>815</b> Cromo mate/Haya, barniz transparente Chromé mat/Hêtre, vernis transparent Dull chrome/Beech, transparent varnish Chrom matt/Buche, transparentlackiert





**Smooth**

Zamak	A	B	C	D
7651	224	232	30	28
7652	192	200	30	28
7653	160	168	30	28

Acabado / Finition / Finish / Oberfläche



038

Níquel cepillado  
Nickelé brossé  
Brushed Nickel  
Gebürstetes Nickel



400

Cromo brillo  
Chromé brillant  
Bright chrome  
Glänzend verchromt

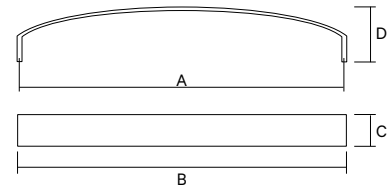

**Straight**

Zamak	B	C	D	E	F
3750	192	202	55	199x52	14

Acabado / Finition / Finish / Oberfläche



800

Cromo mate  
Chromé mat  
Dull chrome  
Matt verchromt

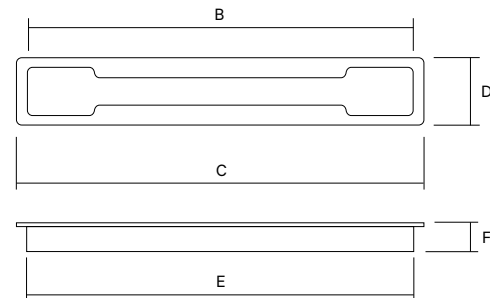

**Slim**

Zamak	B	C	E	F
3541	240	25	235x20	10,7
3542	150	25	145x20	10,7

Acabado / Finition / Finish / Oberfläche



038

Níquel cepillado  
Nickelé brossé  
Brushed Nickel  
Gebürstetes Nickel



800

Cromo mate  
Chromé mat  
Dull chrome  
Matt verchromt

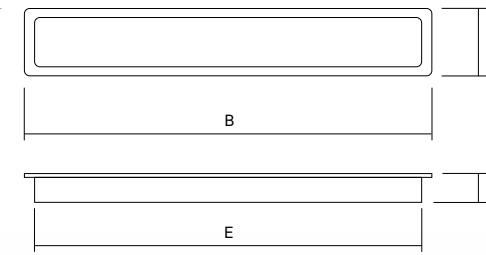

**Seize**

Zamak	B	C	D	E	F
3720	160	180	50	175x45	16

Acabado / Finition / Finish / Oberfläche

			
<b>021</b> Aluminio Aluminium Aluminium Aluminium	<b>038</b> Níquel cepillado Nickelé brossé Brushed Nickel Gebürstetes Nickel	<b>400</b> Cromo brillo Chromé brillant Bright chrome Glänzend verchromt	<b>800</b> Cromo mate Chromé mat Dull chrome Matt verchromt

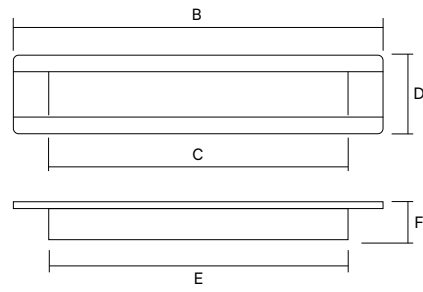

**Seize**

Zamak	B	C	D	E	F
3740	160	180	45	168x40	16

Acabado / Finition / Finish / Oberfläche

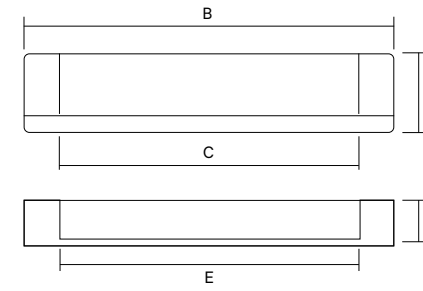
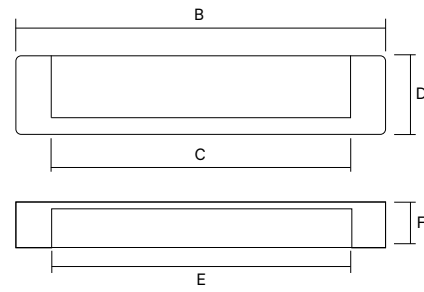

<b>021</b> Aluminio Aluminium Aluminium Aluminium



**Seize**

Zamak	B	C	D	E	F
3730	170	180	25	157x19	18





Acabado / Finition / Finish / Oberfläche



<b>021</b> Aluminio Aluminium Aluminium Aluminium

**Stripe**

Zamak	A	B	C	D
7681	192	238	25	27
7682	160	195	24	27
7683	128	153	23	27
7684	96	120	22	27

Acabado / Finition / Finish / Oberfläche

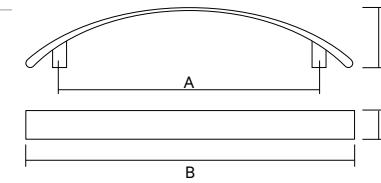
			
<b>021</b> Aluminio Aluminium Aluminium Aluminium	<b>038</b> Níquel cepillado Nickelé brossé Brushed Nickel Gebürstetes Nickel	<b>400</b> Cromo brillo Chromé brillant Bright chrome Glänzend verchromt	<b>800</b> Cromo mate Chromé mat Dull chrome Matt verchromt





**Block**

Zamak	A	B	C	D
7461	160	197	21	25
7462	128	161	19	25
7463	96	129	18	25

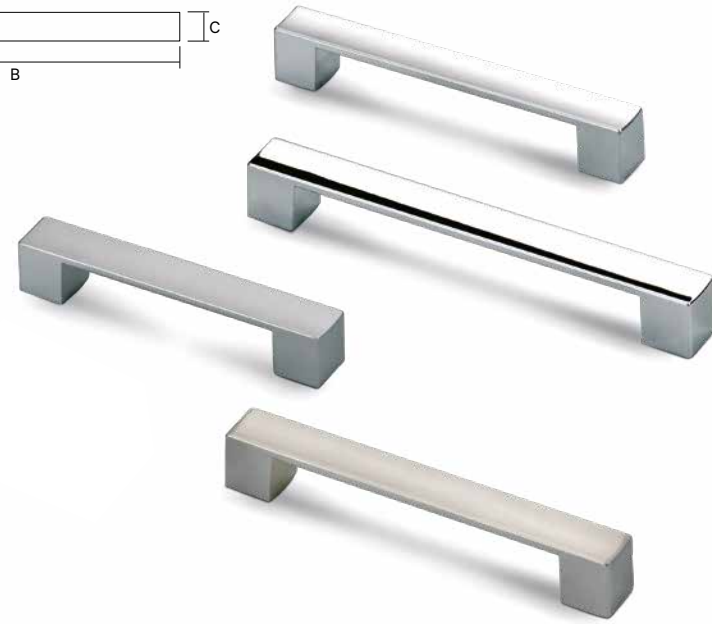
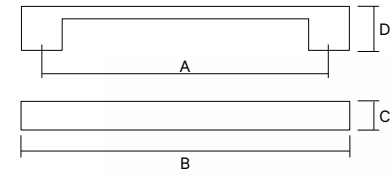

Acabado / Finition / Finish / Oberfläche

<b>021</b> Aluminio Aluminium Aluminium Aluminium	<b>038</b> Níquel cepillado Nickelé brossé Brushed Nickel Gebürstetes Nickel	<b>400</b> Cromo brillo Chromé brillant Bright chrome Glänzend verchromt	<b>800</b> Cromo mate Chromé mat Dull chrome Matt verchromt

**Block**

Zamak	B	C	D	E
8080	16	37	25	24x12

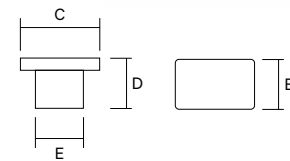

Acabado / Finition / Finish / Oberfläche

<b>038</b> Níquel cepillado Nickelé brossé Brushed Nickel Gebürstetes Nickel	<b>400</b> Cromo brillo Chromé brillant Bright chrome Glänzend verchromt	<b>800</b> Cromo mate Chromé mat Dull chrome Matt verchromt

**Alustyle**

Zamak	A	B	C	D
7020	448	462	14	35
7021	384	398	14	35
7022	288	302	14	35
7023	224	238	14	35
7024	192	206	14	35
7025	160	174	14	35
7026	128	142	14	35
7520	832	846	14	35
7521	640	654	14	35

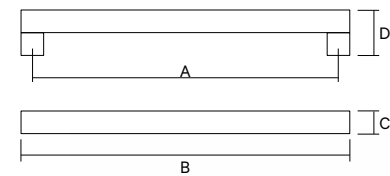

Acabado / Finition / Finish / Oberfläche

<b>018</b> Aluminio anodizado Aluminium anodisé Anodized aluminium Aluminium eloxiert

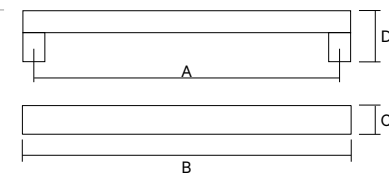

**Square**

Zamak	A	B	C	D
7471	128	146	12	30
7472	96	114	11	30
7473	64	81	10	29

Acabado / Finition / Finish / Oberfläche

<b>021</b> Aluminio Aluminium Aluminium Aluminium	<b>038</b> Níquel cepillado Nickelé brossé Brushed Nickel Gebürstetes Nickel	<b>400</b> Cromo brillo Chromé brillant Bright chrome Glänzend verchromt	<b>800</b> Cromo mate Chromé mat Dull chrome Matt verchromt
<b>808</b> Cobre rústico Cuivre rustique Rustic copper Kupfer rustikal	<b>831</b> Bronce rústico Bronze rustique Antique brass Bronze rustikal	<b>836</b> Estaño rústico Etain rustique Rustic tin Zinn rustikal	

**Square**

Zamak	B	C	D
8090	12	12	24

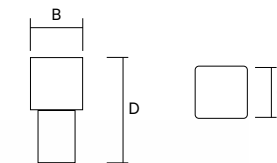

Acabado / Finition / Finish / Oberfläche

<b>021</b> Aluminio Aluminium Aluminium Aluminium	<b>038</b> Níquel cepillado Nickelé brossé Brushed Nickel Gebürstetes Nickel	<b>400</b> Cromo brillo Chromé brillant Bright chrome Glänzend verchromt	<b>800</b> Cromo mate Chromé mat Dull chrome Matt verchromt

**Cubic**

Zamak	A	B	C	D
7481	96	115	12	21
7482	64	85	11	20
7483	32	55	10	19

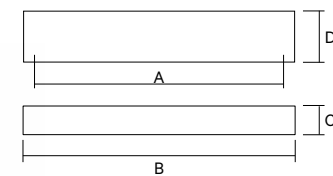

Acabado / Finition / Finish / Oberfläche

<b>021</b> Aluminio Aluminium Aluminium Aluminium	<b>038</b> Níquel cepillado Nickelé brossé Brushed Nickel Gebürstetes Nickel	<b>400</b> Cromo brillo Chromé brillant Bright chrome Glänzend verchromt	<b>800</b> Cromo mate Chromé mat Dull chrome Matt verchromt

**Lava**

Zamak	A	B	C	D
7241	192	200	20	25
7242	160	168	20	25

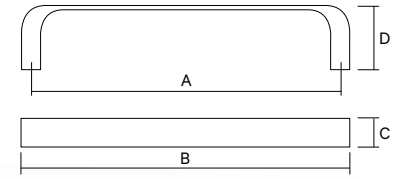

Acabado / Finition / Finish / Oberfläche

021	038	400	800
Aluminio Aluminium Aluminium Aluminium	Níquel cepillado Nickelé brossé Brushed Nickel Gebürstetes Nickel	Cromo brillo Chromé brillant Bright chrome Glänzend verchromt	Cromo mate Chromé mat Dull chrome Matt verchromt



**Daen**

Zamak	B	C	D
8851	50	35	26
8852	35	24	24

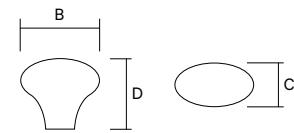

Acabado / Finition / Finish / Oberfläche

038	400	800
Níquel cepillado Nickelé brossé Brushed Nickel Gebürstetes Nickel	Cromo brillo Chromé brillant Bright chrome Glänzend verchromt	Cromo mate Chromé mat Dull chrome Matt verchromt



**Tak**

Zamak	A	B	C	D
7321	192	208	24	26
7322	160	176	24	26

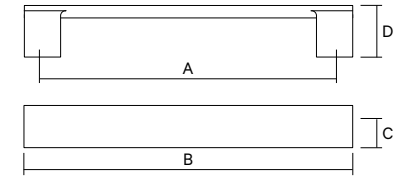

Acabado / Finition / Finish / Oberfläche

021	038	400	800
Aluminio Aluminium Aluminium Aluminium	Níquel cepillado Nickelé brossé Brushed Nickel Gebürstetes Nickel	Cromo brillo Chromé brillant Bright chrome Glänzend verchromt	Cromo mate Chromé mat Dull chrome Matt verchromt

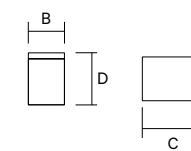

**Tak**

Zamak	B	C	D
8800	20	26	27

Acabado / Finition / Finish / Oberfläche

021	038	400	800
Aluminio Aluminium Aluminium Aluminium	Níquel cepillado Nickelé brossé Brushed Nickel Gebürstetes Nickel	Cromo brillo Chromé brillant Bright chrome Glänzend verchromt	Cromo mate Chromé mat Dull chrome Matt verchromt





**Bridge**

Zamak	A	B	C	D
7131	128	165	20	28
7132	96	130	16	25

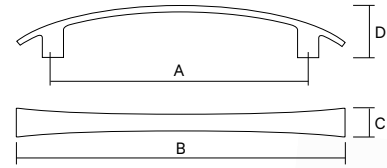

Acabado / Finition / Finish / Oberfläche

<b>021</b> Aluminio Aluminium Aluminium	<b>032</b> Negro mate Noir mat Dull black Mattschwarz	<b>038</b> Níquel cepillado Nickelé brossé Brushed Nickel Gebürstetes Nickel	<b>100</b> Dorado brillo Doré brillant Gold plated Glänzend vergoldet
<b>400</b> Cromo brillo Chromé brillant Bright chrome Glänzend verchromt	<b>500</b> Níquel mate Nickelé mat Dull nickel Matt Nickel	<b>800</b> Cromo mate Chromé mat Dull chrome Matt verchromt	

**Bridge**

Zamak	A	B	C	D
7140	32	53	19	22

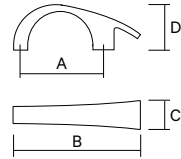

Acabado / Finition / Finish / Oberfläche

<b>021</b> Aluminio Aluminium Aluminium	<b>032</b> Negro mate Noir mat Dull black Mattschwarz	<b>038</b> Níquel cepillado Nickelé brossé Brushed Nickel Gebürstetes Nickel	<b>100</b> Dorado brillo Doré brillant Gold plated Glänzend vergoldet
<b>400</b> Cromo brillo Chromé brillant Bright chrome Glänzend verchromt	<b>500</b> Níquel mate Nickelé mat Dull nickel Matt Nickel	<b>800</b> Cromo mate Chromé mat Dull chrome Matt verchromt	



**Bell**

Zamak	A	B	C	D
7051	128	148	16	35
7052	96	112	13	31

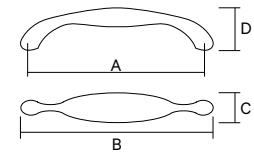

Acabado / Finition / Finish / Oberfläche

<b>038</b> Níquel cepillado Nickelé brossé Brushed Nickel Gebürstetes Nickel	<b>100</b> Dorado brillo Doré brillant Gold plated Glänzend vergoldet	<b>400</b> Cromo brillo Chromé brillant Bright chrome Glänzend verchromt	<b>800</b> Cromo mate Chromé mat Dull chrome Matt verchromt



**Sui**

Zamak	A	B	C	D
7031	128	160	14	28
7032	96	126	13	26

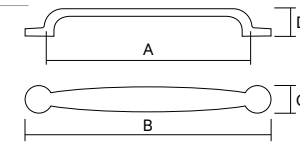

Acabado / Finition / Finish / Oberfläche

<b>030</b> Bronce cepillado Bronze brossé Brushed bronze Gebürstet bronziert	<b>038</b> Níquel cepillado Nickelé brossé Brushed Nickel Gebürstetes Nickel	<b>100</b> Dorado brillo Doré brillant Gold plated Glänzend vergoldet	<b>400</b> Cromo brillo Chromé brillant Bright chrome Glänzend verchromt
<b>800</b> Cromo mate Chromé mat Dull chrome Matt verchromt	<b>807</b> Hierro rústico Fer rustique Rustic iron Eisen rustikal	<b>831</b> Bronce rústico Bronze rustique Antique brass Bronze rustikal	<b>836</b> Estaño rústico Etain rustique Rustic tin Zinn rustikal

**Luk**

Zamak	A	B	C	D
7861	128	164	10	30
7862	96	124	9	29

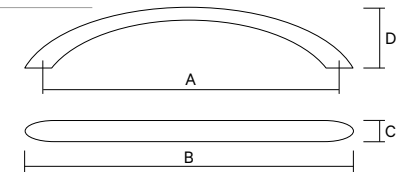

Acabado / Finition / Finish / Oberfläche

<b>002</b> Blanco Blanc White Weiß	<b>021</b> Aluminio Aluminium Aluminium	<b>033</b> Negro brillo Noir brillant Bright black Glänzend schwarz	<b>038</b> Níquel cepillado Nickelé brossé Brushed Nickel Gebürstetes Nickel
<b>100</b> Dorado brillo Doré brillant Gold plated Glänzend vergoldet	<b>400</b> Cromo brillo Chromé brillant Bright chrome Glänzend verchromt	<b>500</b> Níquel mate Nickelé mat Dull nickel Matt Nickel	<b>800</b> Cromo mate Chromé mat Dull chrome Matt verchromt



**Up**

Zamak				
	A	B	C	D
3281	64	90	10	50

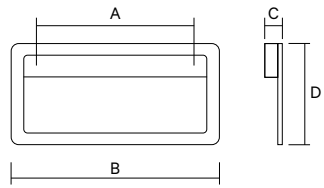

Acabado / Finition / Finish / Oberfläche

<b>002</b> Blanco Blanc White Weiß	<b>038</b> Níquel cepillado Nickelé brossé Brushed Nickel Gebürstetes Nickel	<b>400</b> Cromo brillo Chromé brillant Bright chrome Glänzend verchromt	<b>500</b> Níquel mate Nickelé mat Dull nickel Matt Nickel	<b>800</b> Cromo mate Chromé mat Dull chrome Matt verchromt



**Up**

Zamak				
	A	B	C	D
3282	16	42	10	74

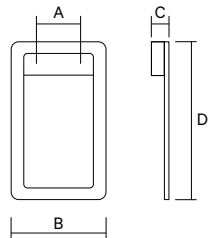

Acabado / Finition / Finish / Oberfläche

<b>002</b> Blanco Blanc White Weiß	<b>038</b> Níquel cepillado Nickelé brossé Brushed Nickel Gebürstetes Nickel	<b>400</b> Cromo brillo Chromé brillant Bright chrome Glänzend verchromt	<b>500</b> Níquel mate Nickelé mat Dull nickel Matt Nickel	<b>800</b> Cromo mate Chromé mat Dull chrome Matt verchromt

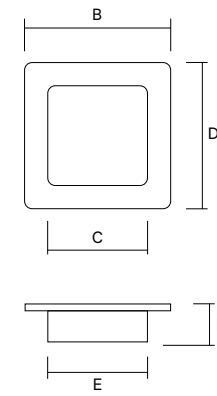

**Stylus**

Zamak					
	B	C	D	E	F
3600	64	60	64	60	11
3560	50	45	50	45	11
3561	39	35	39	35	11
3562	29	26	29	26	11

Acabado / Finition / Finish / Oberfläche

<b>038</b> Níquel cepillado Nickelé brossé Brushed Nickel Gebürstetes Nickel	<b>100</b> Dorado brillo Doré brillant Gold plated Glänzend vergoldet	<b>400</b> Cromo brillo Chromé brillant Bright chrome Glänzend verchromt	<b>800</b> Cromo mate Chromé mat Dull chrome Matt verchromt

**Stylus**

Zamak				
	C	D	E	F
3500	60	65	60	11
3510	45	49	45	11
3511	35	40	35	11
3512	26	30	26	11

Acabado / Finition / Finish / Oberfläche

<b>002</b> Blanco Blanc White Weiß	<b>032</b> Negro mate Noir mat Dull black Mattschwarz	<b>038</b> Níquel cepillado Nickelé brossé Brushed Nickel Gebürstetes Nickel	<b>100</b> Dorado brillo Doré brillant Gold plated Glänzend vergoldet
<b>292</b> Blanco mate Blanc mat Dull white Matt Weiß	<b>400</b> Cromo brillo Chromé brillant Bright chrome Glänzend verchromt	<b>800</b> Cromo mate Chromé mat Dull chrome Matt verchromt	

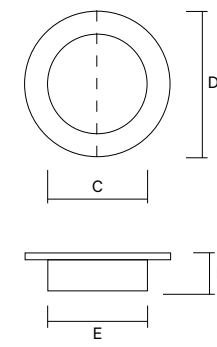



**Nut**

Zamak	B	C	D
8671	34	22	36
8672	31	20	29
8673	25	17	26

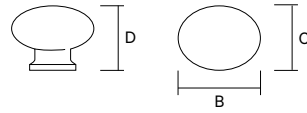

Acabado / Finition / Finish / Oberfläche

<b>038</b> Níquel cepillado Nickelé brossé Brushed Nickel Gebürstetes Nickel	<b>100</b> Dorado brillo Doré brillant Gold plated Glänzend vergoldet	<b>400</b> Cromo brillo Chromé brillant Bright chrome Glänzend verchromt	<b>800</b> Cromo mate Chromé mat Dull chrome Matt verchromt

**Key**

Zamak	A	B	C	D
7291	64	81	12	20
7292	32	48	12	20

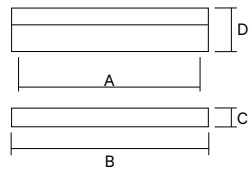

Acabado / Finition / Finish / Oberfläche

<b>021</b> Aluminio Aluminium Aluminium	<b>038</b> Níquel cepillado Nickelé brossé Brushed Nickel Gebürstetes Nickel	<b>400</b> Cromo brillo Chromé brillant Bright chrome Glänzend verchromt	<b>500</b> Níquel mate Nickelé mat Dull nickel Matt Nickel	<b>800</b> Cromo mate Chromé mat Dull chrome Matt verchromt

**Kilt**

Zamak	A	B	C	D
7281	192	242	12	35
7282	128	178	12	35

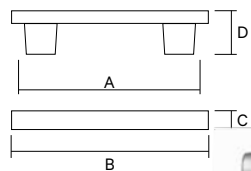

Acabado / Finition / Finish / Oberfläche

<b>038</b> Níquel cepillado Nickelé brossé Brushed Nickel Gebürstetes Nickel	<b>400</b> Cromo brillo Chromé brillant Bright chrome Glänzend verchromt

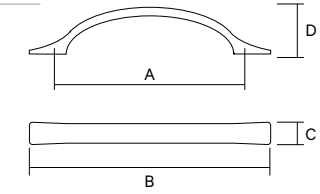

**Zubi**

Zamak	A	B	C	D
7150	96	152	20	27

Acabado / Finition / Finish / Oberfläche

<b>020</b> Oro cepillado Or brossé Brushed Gold Gebürstetes Gold	<b>021</b> Aluminio Aluminium Aluminium	<b>038</b> Níquel cepillado Nickelé brossé Brushed Nickel Gebürstetes Nickel	<b>250</b> Oro mate Or mat Dull gold Matt Gold
<b>400</b> Cromo brillo Chromé brillant Bright chrome Glänzend verchromt	<b>500</b> Níquel mate Nickelé mat Dull nickel Matt Nickel	<b>750</b> Grafito Graphite Graphite Graphit	<b>800</b> Cromo mate Chromé mat Dull chrome Matt verchromt

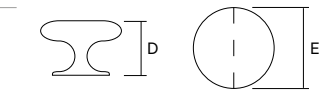

**Halo**

Zamak	D	E
8701	26	35
8702	23	30

Acabado / Finition / Finish / Oberfläche

<b>002</b> Blanco Blanc White Weiß	<b>030</b> Bronce cepillado Bronze brossé Brushed bronze Gebürstet bronziert	<b>038</b> Níquel cepillado Nickelé brossé Brushed Nickel Gebürstetes Nickel	<b>100</b> Dorado brillo Doré brillant Gold plated Glänzend vergoldet
<b>400</b> Cromo brillo Chromé brillant Bright chrome Glänzend verchromt	<b>800</b> Cromo mate Chromé mat Dull chrome Matt verchromt	<b>831</b> Bronce rústico Bronze rustique Antique brass Bronze rustikal	<b>836</b> Estaño rústico Etain rustique Rustic tin Zinn rustikal

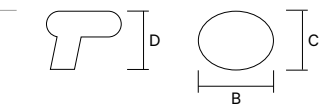

**Golf**

Zamak	B	C	D
8711	37	30	30
8712	32	26	26

Acabado / Finition / Finish / Oberfläche

<b>038</b> Níquel cepillado Nickelé brossé Brushed Nickel Gebürstetes Nickel	<b>800</b> Cromo mate Chromé mat Dull chrome Matt verchromt

**Gumb**

Zamak	D	E
8731	26	35
8732	22	30

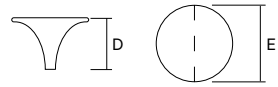

Acabado / Finition / Finish / Oberfläche



**038**  
Níquel cepillado  
Nickelé brossé  
Brushed Nickel  
Gebürstetes Nickel

**Boog**

Zamak	A	B	C	D
7081	128	142	15	32
7082	96	107	13	28

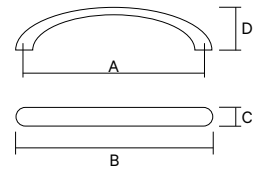

Acabado / Finition / Finish / Oberfläche



**038**  
Níquel cepillado  
Nickelé brossé  
Brushed Nickel  
Gebürstetes Nickel

**Asia**

Zamak	A	B	C	D
7061	96	130	11	28

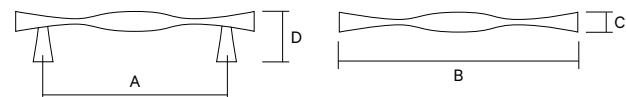

Acabado / Finition / Finish / Oberfläche



**032**  
Negro mate  
Noir mat  
Dull black  
Mattschwarz



**038**  
Níquel cepillado  
Nickelé brossé  
Brushed Nickel  
Gebürstetes Nickel



**100**  
Dorado brillo  
Doré brillant  
Gold plated  
Glänzend vergoldet



**800**  
Cromo mate  
Chromé mat  
Dull chrome  
Matt verchromt

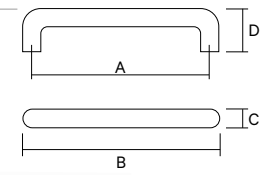

**Assa**

Zamak	A	B	C	D
7552	96	108	10	27
7553	70	80	9	26

Acabado / Finition / Finish / Oberfläche



**002**  
Blanco  
Blanc  
White  
Weiß



**033**  
Negro brillo  
Noir brillant  
Bright black  
Glänzend schwarz



**100**  
Dorado brillo  
Doré brillant  
Gold plated  
Glänzend vergoldet



**400**  
Cromo brillo  
Chromé brillant  
Bright chrome  
Glänzend verchromt

**Assa**

Zamak	A	B	C	D
7554	32	42	9	25

Acabado / Finition / Finish / Oberfläche



**002**  
Blanco  
Blanc  
White  
Weiß



**033**  
Negro brillo  
Noir brillant  
Bright black  
Glänzend schwarz



**100**  
Dorado brillo  
Doré brillant  
Gold plated  
Glänzend vergoldet



**400**  
Cromo brillo  
Chromé brillant  
Bright chrome  
Glänzend verchromt

**Tip**

Zamak	B	C	D
8830	30	19	19

Acabado / Finition / Finish / Oberfläche



**021**  
Aluminio  
Aluminium  
Aluminium  
Aluminium



**038**  
Níquel cepillado  
Nickelé brossé  
Brushed Nickel  
Gebürstetes Nickel



**400**  
Cromo brillo  
Chromé brillant  
Bright chrome  
Glänzend verchromt



**800**  
Cromo mate  
Chromé mat  
Dull chrome  
Matt verchromt

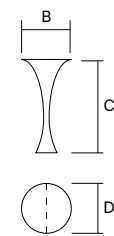

**Tee**

Zamak	B	C	D
8820	16	27	16

Acabado / Finition / Finish / Oberfläche



**021**  
Aluminio  
Aluminium  
Aluminium  
Aluminium



**038**  
Níquel cepillado  
Nickelé brossé  
Brushed Nickel  
Gebürstetes Nickel



**Bold**

Zamak	D	E
8351	40	33
8352	33	28
8353	28	24
8354	23	18

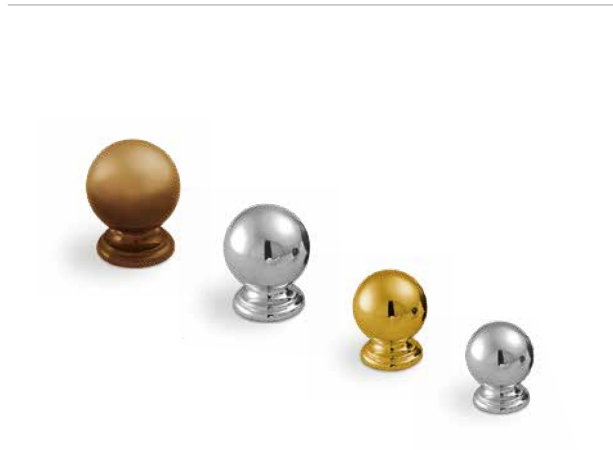
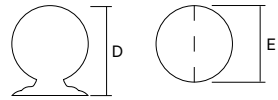

Acabado / Finition / Finish / Oberfläche

<b>100</b> Dorado brillo Doré brillant Gold plated Glänzend vergoldet	<b>400</b> Cromo brillo Chromé brillant Bright chrome Glänzend verchromt	<b>800</b> Cromo mate Chromé mat Dull chrome Matt verchromt	<b>900</b> Bronce viejo Vieux bronze Old bronze Antik bronziert

**Tama**

Zamak	D	E
8321	36	33
8322	32	28
8323	28	24
8324	22	18

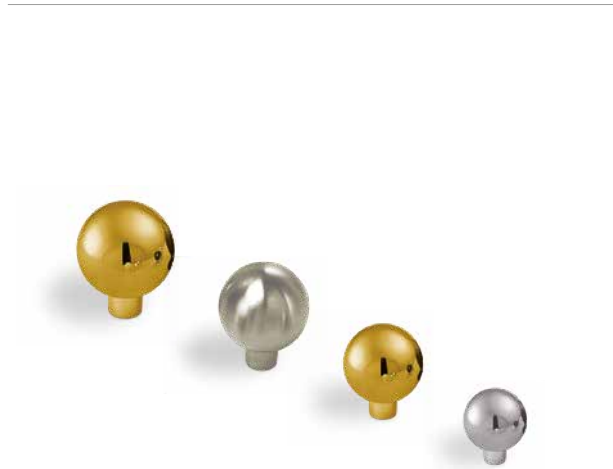
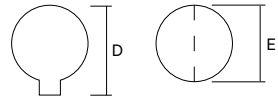

Acabado / Finition / Finish / Oberfläche

<b>038</b> Níquel cepillado Nickelé brossé Brushed Nickel Gebürstetes Nickel	<b>100</b> Dorado brillo Doré brillant Gold plated Glänzend vergoldet	<b>400</b> Cromo brillo Chromé brillant Bright chrome Glänzend verchromt	<b>800</b> Cromo mate Chromé mat Dull chrome Matt verchromt

**Kani**

Zamak	D	E
8010	28	12

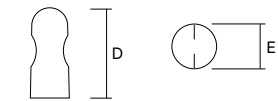

Acabado / Finition / Finish / Oberfläche

<b>002</b> Blanco Blanc White Weiß	<b>021</b> Aluminio Aluminium Aluminium Aluminium	<b>033</b> Negro brillo Noir brillant Bright black Glänzend schwarz	<b>100</b> Dorado brillo Doré brillant Gold plated Glänzend vergoldet	<b>400</b> Cromo brillo Chromé brillant Bright chrome Glänzend verchromt

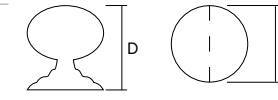

**Dob**

Zamak	D	E
8471	32	35
8472	26	30
8473	23	25

Acabado / Finition / Finish / Oberfläche

<b>100</b> Dorado brillo Doré brillant Gold plated Glänzend vergoldet	<b>102</b> Blanco/Dorado brillo Blanc/Doré brillant White/Gold plated Weiß/Glänzend vergoldet	<b>400</b> Cromo brillo Chromé brillant Bright chrome Glänzend verchromt	<b>900</b> Bronce viejo Vieux bronze Old bronze Antik bronziert

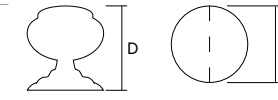

**Tau**

Zamak	D	E
8461	28	35
8462	25	30
8463	21	25

Acabado / Finition / Finish / Oberfläche

<b>100</b> Dorado brillo Doré brillant Gold plated Glänzend vergoldet	<b>805</b> Latón cepillado rústico Laiton brossé rustique Rustic brushed brass Messing rustikal, gebürstet	<b>900</b> Bronce viejo Vieux bronze Old bronze Antik bronziert

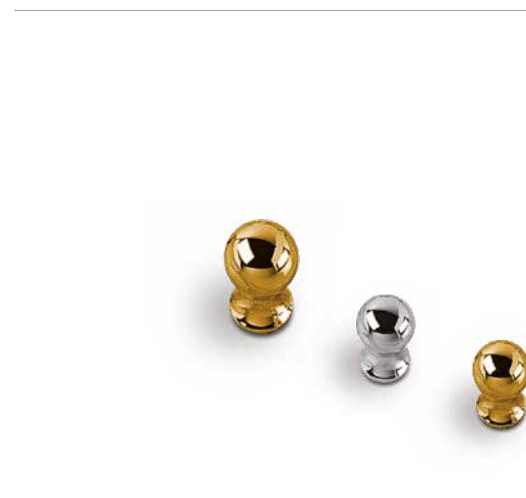
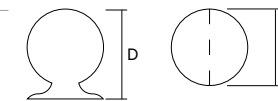

**Med**

Zamak	D	E
8721	28	18
8722	21	13

Acabado / Finition / Finish / Oberfläche

<b>021</b> Aluminio Aluminium Aluminium Aluminium	<b>038</b> Níquel cepillado Nickelé brossé Brushed Nickel Gebürstetes Nickel	<b>100</b> Dorado brillo Doré brillant Gold plated Glänzend vergoldet	<b>400</b> Cromo brillo Chromé brillant Bright chrome Glänzend verchromt

**Toru**

Acero inoxidable-zamak / Acier inox-zamak / Stainless steel-zamak / Rostfreier Stahl-Zamak

	A	B	C	D
7000	1280	1310	14	35
7001	896	926	14	35
7002	672	702	14	35
7003	448	478	14	35
7004	384	414	14	35
7005	288	318	14	35
7006	224	254	14	35
7007	192	222	14	35
7008	160	190	14	35
7009	128	158	14	35

Acabado / Finition / Finish / Oberfläche



031

Inoxidable cepillado  
Inox brossé  
Brushed stainless  
Rostfreier Stahl, gebürstet

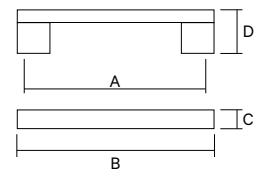

**Rod**

Acero inoxidable-zamak / Acier inox-zamak / Stainless steel-zamak / Rostfreier Stahl-Zamak

	A	B	C	D
7610	288	298	26	10
7611	192	202	25,5	10
7612	160	170	25,5	10
7613	128	138	25,5	10
7614	96	106	25	10
7810	192	200	21	8
7811	160	168	21	8
7812	128	136	21	8
7813	96	104	21	8
7814	64	72	21	8

Acabado / Finition / Finish / Oberfläche



031

Inoxidable cepillado  
Inox brossé  
Brushed stainless  
Rostfreier Stahl, gebürstet



037

Inoxidable pulido  
Inox poli brillant  
Polished stainless  
Rostfreier Stahl, hochglanz

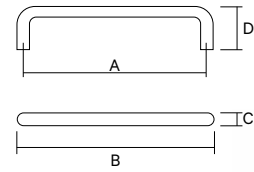

**Unix**

Zamak

	A	B	C	D
7501	320	333	25	38
7502	288	301	25	38
7503	256	269	25	38
7504	224	237	25	38
7505	192	205	25	38
7506	160	173	25	38

Acabado / Finition / Finish / Oberfläche



031

Inoxidable cepillado  
Inox brossé  
Brushed stainless  
Rostfreier Stahl, gebürstet

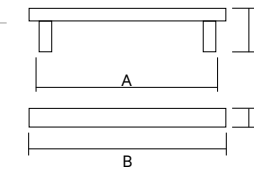
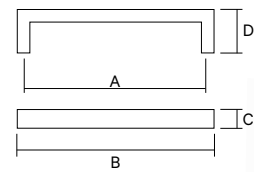

**Ror**

Acero inoxidable-zamak / Acier inox-zamak / Stainless steel-zamak / Rostfreier Stahl-Zamak

	A	B	C	D
7010	1280	1330	12	32
7011	896	946	12	32
7012	672	722	12	32
7013	448	498	12	32
7014	384	434	12	32
7015	288	338	12	32
7016	224	274	12	32
7017	192	242	12	32
7018	160	210	12	32
7019	128	178	12	32

Acabado / Finition / Finish / Oberfläche



031

Inoxidable cepillado  
Inox brossé  
Brushed stainless  
Rostfreier Stahl, gebürstet

**Buis**

Acero inoxidable-zamak / Acier inox-zamak / Stainless steel-zamak / Rostfreier Stahl-Zamak

	A	B	C	D
7921	160	200	10	27
7922	128	166	10	27
7923	96	132	10	27

Acabado / Finition / Finish / Oberfläche



031

Inoxidable cepillado  
Inox brossé  
Brushed stainless  
Rostfreier Stahl, gebürstet

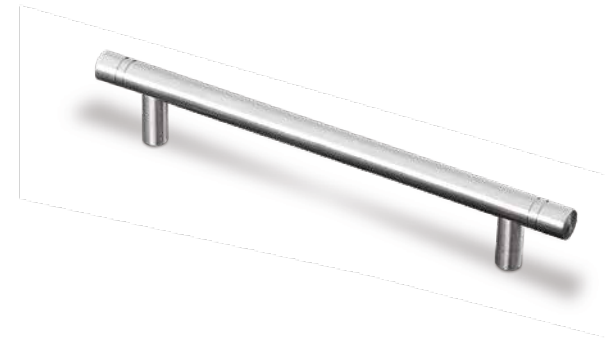
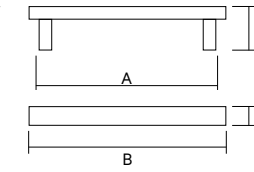

**Buis**

Acero inoxidable-zamak / Acier inox-zamak / Stainless steel-zamak / Rostfreier Stahl-Zamak

	D	E
8921	27	18
8922	22	13

Acabado / Finition / Finish / Oberfläche



031

Inoxidable cepillado  
Inox brossé  
Brushed stainless  
Rostfreier Stahl, gebürstet

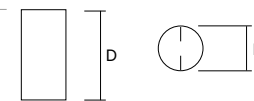



**Dopp**

Acero inoxidable-zamak / Acier inox-zamak / Stainless steel-zamak / Rostfreier Stahl-Zamak

	D	E
8361	35	30
8362	27	25
8363	22	20

Acabado / Finition / Finish / Oberfläche



031

Inoxidable cepillado  
Inox brossé  
Brushed stainless  
Rostfreier Stahl, gebürstet



037

Inoxidable pulido  
Inox poli brillant  
Polished stainless  
Rostfreier Stahl, hochglanz

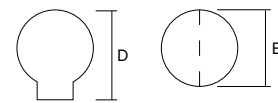

**Pil**

Acero inoxidable-zamak / Acier inox-zamak / Stainless steel-zamak / Rostfreier Stahl-Zamak

	A	B	C	D
7861	128	145	10	30
7862	96	110	10	29

Acabado / Finition / Finish / Oberfläche



031

Inoxidable cepillado  
Inox brossé  
Brushed stainless  
Rostfreier Stahl, gebürstet

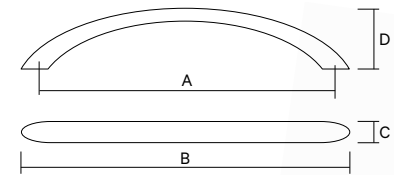

**Orb**

Poli-dur-zamak / Poli-dur-zamak / Poli-dur-zamak / Poli-dur-Zamak

	D	E
5101	38	34
5102	32	28

Acabado / Finition / Finish / Oberfläche



102

Blanco/Dorado brillo  
Blanc/Doré brillant  
White/Gold plated  
Weiß/Glänzend vergoldet



133

Negro brillo/Dorado brillo  
Noir brillant/Doré brillant  
Bright black/Gold plated  
Glänzend schwarz/Glänzend vergoldet

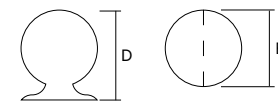

**Klot**

Poli-dur-zamak / Poli-dur-zamak / Poli-dur-zamak / Poli-dur-Zamak

	D	E
5001	36	34
5002	28	28

Acabado / Finition / Finish / Oberfläche



002

Blanco  
Blanc  
White  
Weiß



033

Negro brillo  
Noir brillant  
Bright black  
Glänzend schwarz

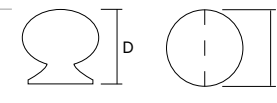
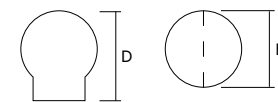

**Nou**

Poli-dur-zamak / Poli-dur-zamak / Poli-dur-zamak / Poli-dur-Zamak

	D	E
5221	30	37
5222	26	32

Acabado / Finition / Finish / Oberfläche



002

Blanco  
Blanc  
White  
Weiß



033

Negro brillo  
Noir brillant  
Bright black  
Glänzend schwarz

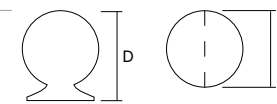

**Polidur**

Poli-dur-zamak / Poli-dur-zamak / Poli-dur-zamak / Poli-dur-Zamak

	D	E
5201	38	34
5202	32	28

Acabado / Finition / Finish / Oberfläche



002

Blanco  
Blanc  
White  
Weiß



033

Negro brillo  
Noir brillant  
Bright black  
Glänzend schwarz

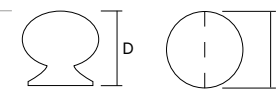

**Sene**

Madera / Bois / Wood / Holz

	D	E
9062	32	40
9063	25	30

Acabado / Finition / Finish / Oberfläche



014

Haya, sin barniz  
Hêtre, non verni  
Beech, unvarnished  
Buche, unlackiert



015

Haya, barniz transparente  
Hêtre, vernis transparent  
Beech, transparent varnish  
Buche, transparentlackiert



016

Haya, barniz nogal  
Hêtre, vernis noyer  
Beech, walnut varnish  
Buche, Nußbaum lackiert



025

Pino, barniz transparente  
Pin, vernis transparent  
Pine, transparent varnish  
Kiefer, transparentlackiert



035

Roble, barniz transparente  
Chêne, vernis transparent  
Oak, transparent varnish  
Eiche, transparentlackiert

**Skal**

Zamak	A	B	C	D
3940	64	130	25	34

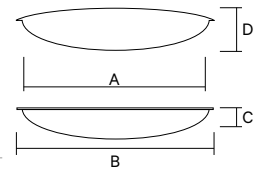

Acabado / Finition / Finish / Oberfläche

<b>021</b> Aluminio Aluminium Aluminium Aluminium	<b>038</b> Níquel cepillado Nickelé brossé Brushed Nickel Gebürstetes Nickel	<b>805</b> Latón cepillado rústico Laiton brossé rustique Rustic brushed brass Messing rustikal, gebürstet
<b>807</b> Hierro rústico Fer rustique Rustic iron Eisen rustikal	<b>836</b> Estaño rústico Etain rustique Rustic tin Zinn rustikal	



**Shift**

Zamak	B	C	D	E	F
3701	145	111	50	139x40	11
3702	113	85	42	110x35	11
3703	83	78	36	78x26	11

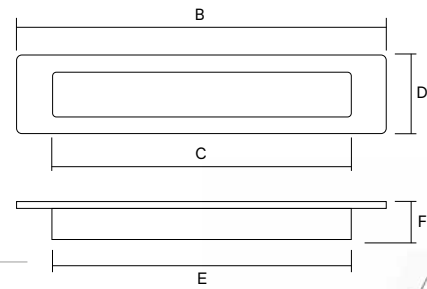

Acabado / Finition / Finish / Oberfläche

<b>038</b> Níquel cepillado Nickelé brossé Brushed Nickel Gebürstetes Nickel	<b>100</b> Dorado brillo Doré brillant Gold plated Glänzend vergoldet	<b>400</b> Cromo brillo Chromé brillant Bright chrome Glänzend verchromt	<b>800</b> Cromo mate Chromé mat Dull chrome Matt verchromt

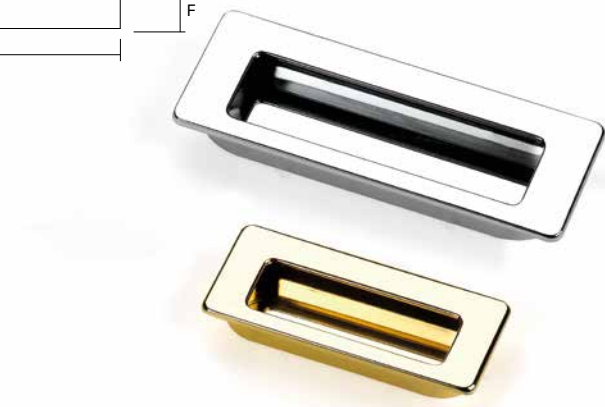

**Vora**

Zamak	B	C	D	E	F
3261	80	60	35	71	5

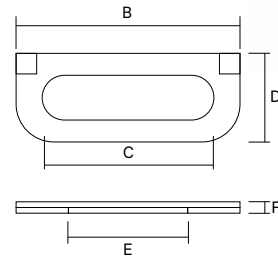

Acabado / Finition / Finish / Oberfläche

<b>002</b> Blanco Blanc White Weiß	<b>038</b> Níquel cepillado Nickelé brossé Brushed Nickel Gebürstetes Nickel	<b>100</b> Dorado brillo Doré brillant Gold plated Glänzend vergoldet
<b>500</b> Níquel mate Nickelé mat Dull nickel Matt Nickel	<b>800</b> Cromo mate Chromé mat Dull chrome Matt verchromt	

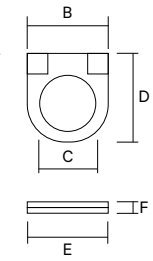

**Vora**

Zamak	B	C	D	E	F
3262	36	22	36	27	5

Acabado / Finition / Finish / Oberfläche

<b>002</b> Blanco Blanc White Weiß	<b>038</b> Níquel cepillado Nickelé brossé Brushed Nickel Gebürstetes Nickel	<b>100</b> Dorado brillo Doré brillant Gold plated Glänzend vergoldet
<b>500</b> Níquel mate Nickelé mat Dull nickel Matt Nickel	<b>800</b> Cromo mate Chromé mat Dull chrome Matt verchromt	

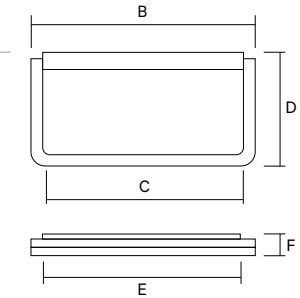

**Toka**

Zamak	B	C	D	E	F
3251	72	57	40	62	6

Acabado / Finition / Finish / Oberfläche

<b>112</b> Dorado brillo/Pintado dorado Doré brillant/Peint en doré Gold plated/Gold painted Glänzend vergoldet/Golden bemalt	<b>413</b> Cromo brillo/Pintado plata Chromé brillant/Peint en argenté Bright chrome/Silver painted Glänzend verchromt/Silbern bemalt

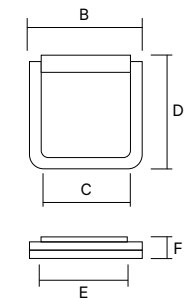

**Toka**

Zamak	B	C	D	E	F
3252	35	23	35	28	6

Acabado / Finition / Finish / Oberfläche

<b>112</b> Dorado brillo/Pintado dorado Doré brillant/Peint en doré Gold plated/Gold painted Glänzend vergoldet/Golden bemalt	<b>413</b> Cromo brillo/Pintado plata Chromé brillant/Peint en argenté Bright chrome/Silver painted Glänzend verchromt/Silbern bemalt





**Cap**

Zamak	B	C	D	E	F
3921	150	99	40	103x26	11
3922	110	65	36	69x26	11

Acabado / Finition / Finish / Oberfläche

<b>002</b> Blanco Blanc White Weiß	<b>038</b> Níquel cepillado Nickelé brossé Brushed Nickel Gebürstetes Nickel	<b>100</b> Dorado brillo Doré brillant Gold plated Glänzend vergoldet
<b>400</b> Cromo brillo Chromé brillant Bright chrome Glänzend verchromt	<b>800</b> Cromo mate Chromé mat Dull chrome Matt verchromt	<b>831</b> Bronce rústico Bronze rustique Antique brass Bronze rustikal

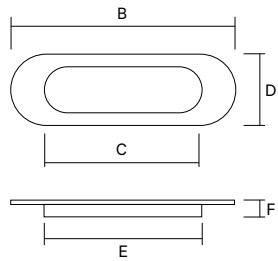

**Frame**

Zamak	B	C	D	E	F
3271	82	63	38	57	5

Acabado / Finition / Finish / Oberfläche

<b>100</b> Dorado brillo Doré brillant Gold plated Glänzend vergoldet	<b>200</b> Dorado satinado Doré satiné Satin gold plated Satiniertes gold	<b>500</b> Níquel mate Nickelé mat Dull nickel Matt Nickel

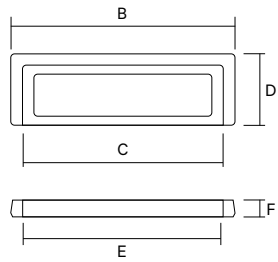

**Frame**

Zamak	B	C	D	E	F
3272	38	26	50	21	5

Acabado / Finition / Finish / Oberfläche

<b>100</b> Dorado brillo Doré brillant Gold plated Glänzend vergoldet	<b>200</b> Dorado satinado Doré satiné Satin gold plated Satiniertes gold	<b>500</b> Níquel mate Nickelé mat Dull nickel Matt Nickel

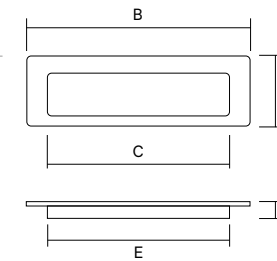
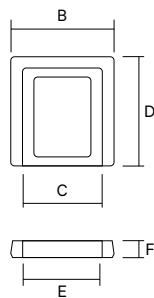

**Flute**

Zamak	B	C	D	E	F
3801	115		42	93x32	13
3802	80		36	67x27	13

Acabado / Finition / Finish / Oberfläche

<b>112</b> Dorado brillo/Pintado dorado Doré brillant/Peint en doré Gold plated/Gold painted Glänzend vergoldet/Golden bemalt	<b>403</b> Cromo brillo/Negro Chromé brillant/Noir Bright chrome/Black Glänzend verchromt/Schwarz
<b>413</b> Cromo brillo/Pintado plata Chromé brillant/Peint en argenté Bright chrome/Silver painted Glänzend verchromt/Silbern bemalt	

**Grin**

Zamak	B	C	D	E	F
3900	110	96	40	104x30	12

Acabado / Finition / Finish / Oberfläche

<b>112</b> Dorado brillo/Pintado dorado Doré brillant/Peint en doré Gold plated/Gold painted Glänzend vergoldet/Golden bemalt	<b>413</b> Cromo brillo/Pintado plata Chromé brillant/Peint en argenté Bright chrome/Silver painted Glänzend verchromt/Silbern bemalt

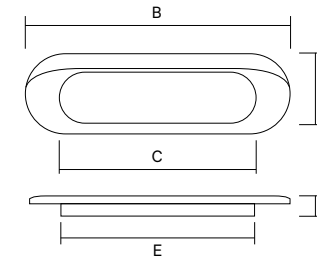
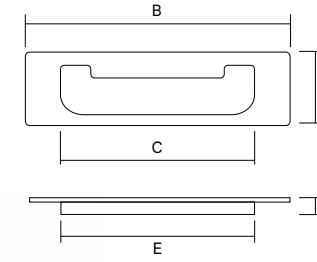

**Flap**

Zamak	B	C	D	E	F
3930	110	96	40	88x30	12

Acabado / Finition / Finish / Oberfläche

<b>112</b> Dorado brillo/Pintado dorado Doré brillant/Peint en doré Gold plated/Gold painted Glänzend vergoldet/Golden bemalt	<b>413</b> Cromo brillo/Pintado plata Chromé brillant/Peint en argenté Bright chrome/Silver painted Glänzend verchromt/Silbern bemalt

**Provence**

Zamak	A	B	C	D
6521	96	154	22	30

Acabado / Finition / Finish / Oberfläche

		
<b>805</b> Latón cepillado rústico Laiton brossé rustique Rustic brushed brass Messing rustikal, gebürstet	<b>825</b> Estaño cepillado Etain brossé Brushed tin Zinn gebürstet	<b>831</b> Bronce rústico Bronze rustique Antique brass Bronze rustikal

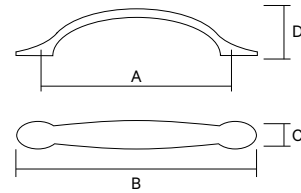

**Provence**

Zamak	D	E
8521	36	24

Acabado / Finition / Finish / Oberfläche



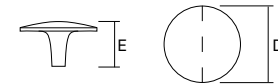

		
<b>805</b> Latón cepillado rústico Laiton brossé rustique Rustic brushed brass Messing rustikal, gebürstet	<b>825</b> Estaño cepillado Etain brossé Brushed tin Zinn gebürstet	<b>831</b> Bronce rústico Bronze rustique Antique brass Bronze rustikal



**Laps**

Zamak	A	B	C	D
6131	192	222	22	21
6132	128	159	22	21

Acabado / Finition / Finish / Oberfläche

		
<b>100</b> Dorado brillo Doré brillant Gold plated Glänzend vergoldet	<b>400</b> Cromo brillo Chromé brillant Bright chrome Glänzend verchromt	<b>500</b> Níquel mate Nickelé mat Dull nickel Matt Nickel
		
<b>831</b> Bronce rústico Bronze rustique Antique brass Bronze rustikal	<b>836</b> Estaño rústico Etain rustique Rustic tin Zinn rustikal	

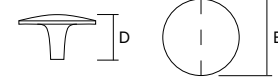
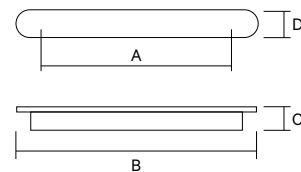

**Laps**

Zamak	D	E
6130	23	45

Acabado / Finition / Finish / Oberfläche

		
<b>100</b> Dorado brillo Doré brillant Gold plated Glänzend vergoldet	<b>400</b> Cromo brillo Chromé brillant Bright chrome Glänzend verchromt	<b>500</b> Níquel mate Nickelé mat Dull nickel Matt Nickel
		
<b>831</b> Bronce rústico Bronze rustique Antique brass Bronze rustikal	<b>836</b> Estaño rústico Etain rustique Rustic tin Zinn rustikal	

**Rough**

Zamak	A	B	C	D
6151	128	169	25	27
6152	96	127	23	26

Acabado / Finition / Finish / Oberfläche

			
<b>400</b> Cromo brillo Chromé brillant Bright chrome Glänzend verchromt	<b>500</b> Níquel mate Nickelé mat Dull nickel Matt Nickel	<b>831</b> Bronce rústico Bronze rustique Antique brass Bronze rustikal	<b>836</b> Estaño rústico Etain rustique Rustic tin Zinn rustikal

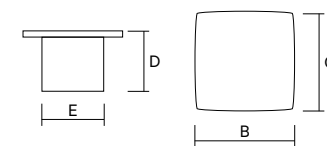
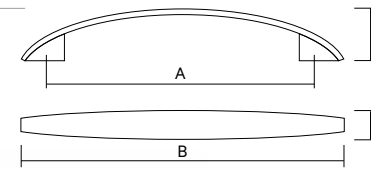

**Rough**

Zamak	B	C	D	E
6150	42	42	25	24x24

Acabado / Finition / Finish / Oberfläche

			
<b>400</b> Cromo brillo Chromé brillant Bright chrome Glänzend verchromt	<b>500</b> Níquel mate Nickelé mat Dull nickel Matt Nickel	<b>831</b> Bronce rústico Bronze rustique Antique brass Bronze rustikal	<b>836</b> Estaño rústico Etain rustique Rustic tin Zinn rustikal



**Rope**

Zamak	A	B	C	D
7581	128	150	15	30
7582	96	114	13	27

Acabado / Finition / Finish / Oberfläche

<b>100</b> Dorado brillo Doré brillant Gold plated Glänzend vergoldet	<b>500</b> Níquel mate Nickelé mat Dull nickel Matt Nickel	<b>810</b> Negro petróleo Noir pétrole Oil rubbed bronze Ölgeschwartzte Bronze
<b>825</b> Estaño cepillado Etain brossé Brushed tin Zinn gebürstet	<b>831</b> Bronce rústico Bronze rustique Antique brass Bronze rustikal	<b>836</b> Estaño rústico Etain rustique Rustic tin Zinn rustikal

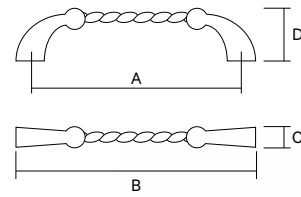

**Rope**

Zamak	D	E
8581	23	34

Acabado / Finition / Finish / Oberfläche

<b>100</b> Dorado brillo Doré brillant Gold plated Glänzend vergoldet	<b>500</b> Níquel mate Nickelé mat Dull nickel Matt Nickel	<b>810</b> Negro petróleo Noir pétrole Oil rubbed bronze Ölgeschwartzte Bronze
<b>825</b> Estaño cepillado Etain brossé Brushed tin Zinn gebürstet	<b>831</b> Bronce rústico Bronze rustique Antique brass Bronze rustikal	<b>836</b> Estaño rústico Etain rustique Rustic tin Zinn rustikal

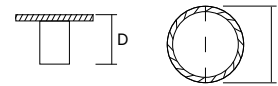

**Helix**

Zamak	A	B	C	D
7421	96	120	14	27
7422	64	81	11	22

Acabado / Finition / Finish / Oberfläche

<b>805</b> Latón cepillado rústico Laiton brossé rustique Rustic brushed brass Messing rustikal, gebürstet	<b>807</b> Hierro rústico Fer rustique Rustic iron Eisen rustikal	<b>808</b> Cobre rústico Cuivre rustique Rustic copper Kupfer rustikal
<b>809</b> Níquel negro cepillado rústico Nickelé noir brossé rustique Black nickel rustic brushed Nickel schwarz rustikal, gebürstet	<b>831</b> Bronce rústico Bronze rustique Antique brass Bronze rustikal	<b>836</b> Estaño rústico Etain rustique Rustic tin Zinn rustikal

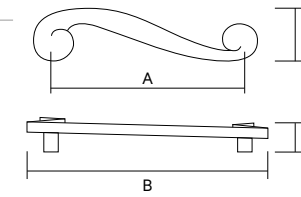

**Helix**

Zamak	D	E
8871	25	30

Acabado / Finition / Finish / Oberfläche

<b>805</b> Latón cepillado rústico Laiton brossé rustique Rustic brushed brass Messing rustikal, gebürstet	<b>807</b> Hierro rústico Fer rustique Rustic iron Eisen rustikal	<b>808</b> Cobre rústico Cuivre rustique Rustic copper Kupfer rustikal
<b>809</b> Níquel negro cepillado rústico Nickelé noir brossé rustique Black nickel rustic brushed Nickel schwarz rustikal, gebürstet	<b>831</b> Bronce rústico Bronze rustique Antique brass Bronze rustikal	<b>836</b> Estaño rústico Etain rustique Rustic tin Zinn rustikal

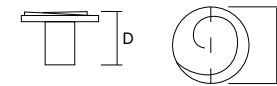

**Reed**

Zamak				
	<b>B</b>	<b>C</b>	<b>D</b>	<b>E</b>
8491	35	30	22	13x8

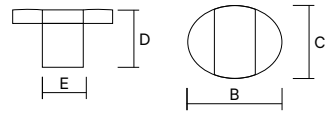

**Reed**

Zamak				
	<b>A</b>	<b>B</b>	<b>C</b>	<b>D</b>
7491	128	163	20	32
7492	96	128	16	27

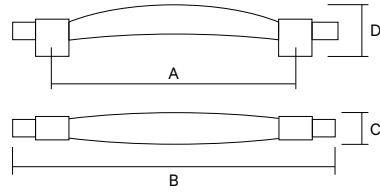

Acabado / Finition / Finish / Oberfläche

<b>100</b> Dorado brillo Doré brillant Gold plated Glänzend vergoldet	<b>500</b> Níquel mate Nickel mat Dull nickel Matt Nickel	<b>810</b> Negro petróleo Noir pétrole Oil rubbed bronze Olgeschwärzte Bronze
<b>825</b> Estaño cepillado Etain brossé Brushed tin Zinn gebürstet	<b>831</b> Bronce rústico Bronze rustique Antique brass Bronze rustikal	<b>836</b> Estaño rústico Etain rustique Rustic tin Zinn rustikal



**Diabolo**

Zamak		
	<b>D</b>	<b>E</b>
2880	35	60

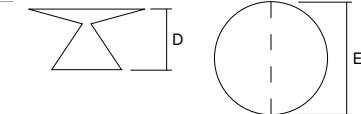

Acabado / Finition / Finish / Oberfläche

<b>032</b> Negro mate Noir mat Dull black Mattschwarz	<b>038</b> Níquel cepillado Nickel brossé Brushed Nickel Gebürstetes Nickel	<b>292</b> Blanco mate Blanc mat Dull white Matt Weiß
<b>400</b> Cromo brillo Chromé brillant Bright chrome Glänzend verchromt	<b>800</b> Cromo mate Chromé mat Dull chrome Matt verchromt	<b>831</b> Bronce rústico Bronze rustique Antique brass Bronze rustikal

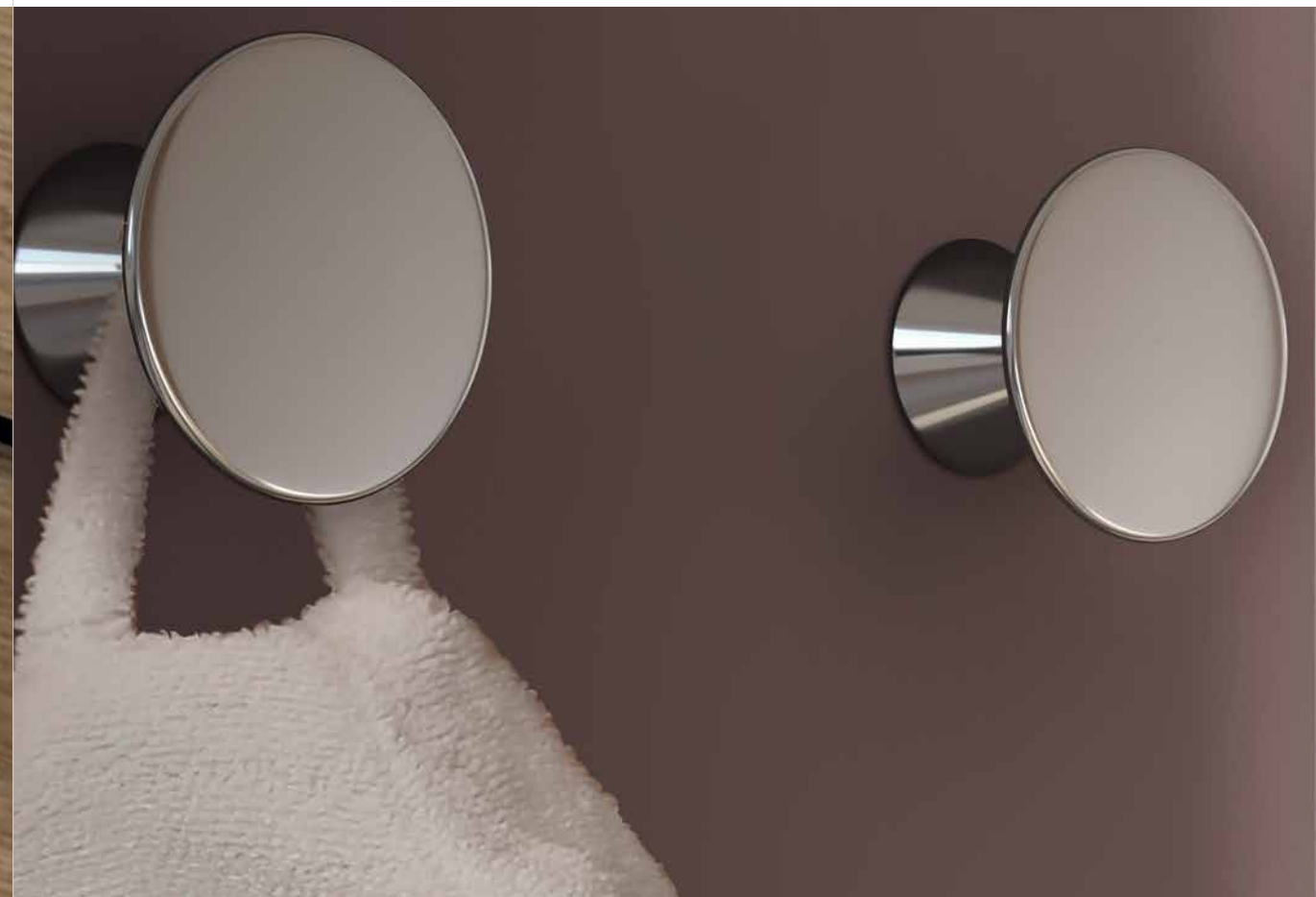





**Chess**

Zamak	A	B	C	D
7191	128	161	21	25
7192	96	136	16	24

Acabado / Finition / Finish / Oberfläche

		
<b>100</b> Dorado brillo Doré brillant Gold plated Glänzend vergoldet	<b>500</b> Níquel mate Nickelé mat Dull nickel Matt Nickel	<b>810</b> Negro petróleo Noir pétrole Oil rubbed bronze Ölgeschwartzte Bronze
		
<b>825</b> Estaño cepillado Etain brossé Brushed tin Zinn gebürstet	<b>831</b> Bronce rústico Bronze rustique Antique brass Bronze rustikal	<b>836</b> Estaño rústico Etain rustique Rustic tin Zinn rustikal

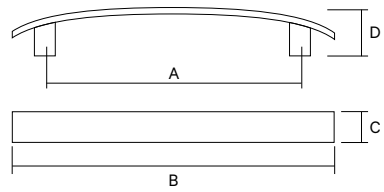

**Chess**

Zamak	B	C	D	E
8191	34	34	24	10
8192	29	29	22	9

Acabado / Finition / Finish / Oberfläche

		
<b>100</b> Dorado brillo Doré brillant Gold plated Glänzend vergoldet	<b>500</b> Níquel mate Nickelé mat Dull nickel Matt Nickel	<b>810</b> Negro petróleo Noir pétrole Oil rubbed bronze Ölgeschwartzte Bronze
		
<b>825</b> Estaño cepillado Etain brossé Brushed tin Zinn gebürstet	<b>831</b> Bronce rústico Bronze rustique Antique brass Bronze rustikal	<b>836</b> Estaño rústico Etain rustique Rustic tin Zinn rustikal

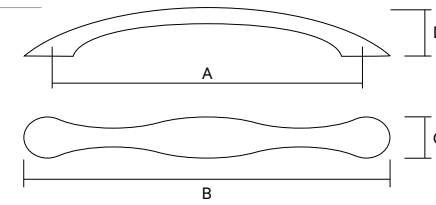
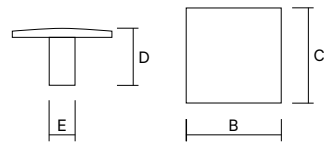

**Graph**

Zamak	A	B	C	D
7371	128	178	22	31
7372	96	137	20	28





Acabado / Finition / Finish / Oberfläche

		
<b>038</b> Níquel cepillado Nickelé brossé Brushed Nickel Gebürstetes Nickel	<b>808</b> Cobre rústico Cuivre rustique Rustic copper Kupfer rustikal	<b>809</b> Níquel negro cepillado rústico Nickelé noir brossé rustique Black nickel rustic brushed Nickel schwarz rustikal, gebürstet
		
<b>831</b> Bronce rústico Bronze rustique Antique brass Bronze rustikal	<b>836</b> Estaño rústico Etain rustique Rustic tin Zinn rustikal	

**Graph**

Zamak	D	E
8841	26	34
8842	24	28

Acabado / Finition / Finish / Oberfläche

		
<b>038</b> Níquel cepillado Nickelé brossé Brushed Nickel Gebürstetes Nickel	<b>808</b> Cobre rústico Cuivre rustique Rustic copper Kupfer rustikal	<b>809</b> Níquel negro cepillado rústico Nickelé noir brossé rustique Black nickel rustic brushed Nickel schwarz rustikal, gebürstet
		
<b>831</b> Bronce rústico Bronze rustique Antique brass Bronze rustikal	<b>836</b> Estaño rústico Etain rustique Rustic tin Zinn rustikal	

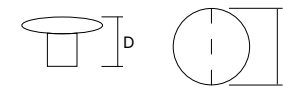

**Osa**

Porcelana-zamak / Porcelaine-zamak / Porcelain-zamak / Porzellan-Zamak

	A	B	C	D
7830	96	110	14	30

Acabado / Finition / Finish / Oberfläche

		
<b>100</b> Dorado brillo Doré brillant Gold plated Glänzend vergoldet	<b>102</b> Blanco/Dorado brillo Blanc/Doré brillant White/Gold plated Weiß/Glänzend vergoldet	<b>831</b> Bronce rústico Bronze rustique Antique brass Bronze rustikal
		
<b>836</b> Estaño rústico Etain rustique Rustic tin Zinn rustikal	<b>900</b> Bronce viejo Vieux bronze Old bronze Antik bronziert	

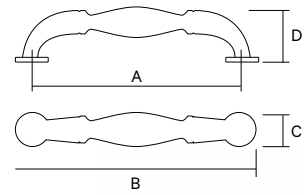

**Buckle**

Zamak

	A	B	C	D
7251	128	149	20	30
7252	96	117	18	26

Acabado / Finition / Finish / Oberfläche

		
<b>038</b> Níquel cepillado Nickelé brossé Brushed Nickel Gebürstetes Nickel	<b>100</b> Dorado brillo Doré brillant Gold plated Glänzend vergoldet	<b>805</b> Latón cepillado rústico Laiton brossé rustique Rustic brushed brass Messing rustikal, gebürstet
		
<b>831</b> Bronce rústico Bronze rustique Antique brass Bronze rustikal	<b>836</b> Estaño rústico Etain rustique Rustic tin Zinn rustikal	

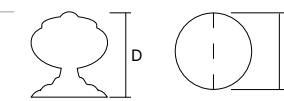
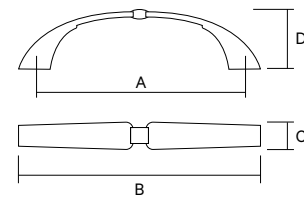

**Wavy**

Zamak

	D	E
8651	30	35
8652	25	30
8653	22	25

Acabado / Finition / Finish / Oberfläche

			
<b>100</b> Dorado brillo Doré brillant Gold plated Glänzend vergoldet	<b>831</b> Bronce rústico Bronze rustique Antique brass Bronze rustikal	<b>836</b> Estaño rústico Etain rustique Rustic tin Zinn rustikal	<b>900</b> Bronce viejo Vieux bronze Old bronze Antik bronziert

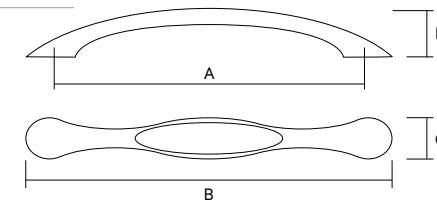



**Liki**

Porcelana-zamak / Porcelaine-zamak / Porcelain-zamak / Porzellan-Zamak

	A	B	C	D
9821	128	178	22	31
9822	96	137	20	28

Acabado / Finition / Finish / Oberfläche

	
<b>805</b> Latón cepillado rústico Laiton brossé rustique Rustic brushed brass Messing rustikal, gebürstet	<b>831</b> Craquelé/Bronce rústico Craquelé/Bronze rustique Craquelé/Antique brass Craquelé/Bronze rustikal

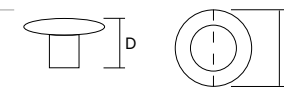

**Liki**

Porcelana-zamak / Porcelaine-zamak / Porcelain-zamak / Porzellan-Zamak

	D	E
9831	26	34
9832	24	28

Acabado / Finition / Finish / Oberfläche

	
<b>805</b> Latón cepillado rústico Laiton brossé rustique Rustic brushed brass Messing rustikal, gebürstet	<b>831</b> Craquelé/Bronce rústico Craquelé/Bronze rustique Craquelé/Antique brass Craquelé/Bronze rustikal





**Hana**

Porcelana-zamak / Porcelaine-zamak / Porcelain-zamak / Porzellan-Zamak

	A	B	C	D
9841	128	178	22	31
9842	96	137	20	28

Acabado / Finition / Finish / Oberfläche



**805**  
Latón cepillado rústico  
Laiton brossé rustique  
Rustic brushed brass  
Messing rustikal, gebürstet



**831**  
Marfil, decorada/Bronce rústico  
Ivoire, décorée/Bronze rustique  
Ivory, decorated/Antique brass  
Elfenbein, dekoriert/Bronze rustikal

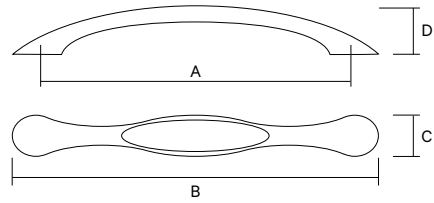

**Hana**

Porcelana-zamak / Porcelaine-zamak / Porcelain-zamak / Porzellan-Zamak

	D	E
9851	26	34
9852	24	28

Acabado / Finition / Finish / Oberfläche



**805**  
Latón cepillado rústico  
Laiton brossé rustique  
Rustic brushed brass  
Messing rustikal, gebürstet



**831**  
Marfil, decorada/Bronce rústico  
Ivoire, décorée/Bronze rustique  
Ivory, decorated/Antique brass  
Elfenbein, dekoriert/Bronze rustikal

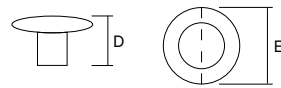

**Vlak**

Porcelana-zamak / Porcelaine-zamak / Porcelain-zamak / Porzellan-Zamak

	A	B	C	D
9700	96	110	14	31

Acabado / Finition / Finish / Oberfläche



**102**  
Blanco/Dorado brillo  
Blanc/Doré brillant  
White/Gold plated  
Weiß/Glänzend vergoldet



**836**  
Blanco/Estaño rústico  
Blanc/Etain rustique  
White/Rustic tin  
Weiß/Zinn rustikal



**902**  
Blanco/Bronce viejo  
Blanc/Vieux bronze  
White/Old bronze  
Weiß/Antik bronziert

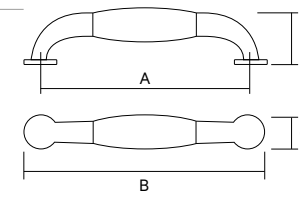
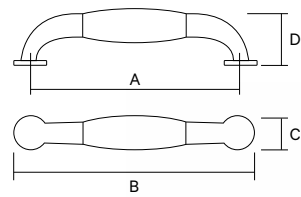

**Gele**

Porcelana-zamak / Porcelaine-zamak / Porcelain-zamak / Porzellan-Zamak

	A	B	C	D
9770	96	110	14	31

Acabado / Finition / Finish / Oberfläche



**109**  
Marfil, decorada/Dorado brillo  
Ivoire, décorée/Doré brillant  
Ivory, decorated/Gold plated  
Elfenbein, dekoriert/Glänzend vergoldet



**831**  
Marfil, decorada/Bronce rústico  
Ivoire, décorée/Bronze rustique  
Ivory, decorated/Antique brass  
Elfenbein, dekoriert/Bronze rustikal



**836**  
Marfil, decorada/Estaño rústico  
Ivoire, décorée/Etain rustique  
Ivory, decorated/Rustic tin  
Elfenbein, dekoriert/Zinn rustikal



**909**  
Marfil, decorada/Bronce viejo  
Ivoire, décorée/Vieux bronze  
Ivory, decorated/Old bronze  
Elfenbein, dekoriert/Antik bronziert

**Gele**

Porcelana-zamak / Porcelaine-zamak / Porcelain-zamak / Porzellan-Zamak

	D	E
9771	28	37
9772	23	30

Acabado / Finition / Finish / Oberfläche



**109**  
Marfil, decorada/Dorado brillo  
Ivoire, décorée/Doré brillant  
Ivory, decorated/Gold plated  
Elfenbein, dekoriert/Glänzend vergoldet



**831**  
Marfil, decorada/Bronce rústico  
Ivoire, décorée/Bronze rustique  
Ivory, decorated/Antique brass  
Elfenbein, dekoriert/Bronze rustikal



**836**  
Marfil, decorada/Estaño rústico  
Ivoire, décorée/Etain rustique  
Ivory, decorated/Rustic tin  
Elfenbein, dekoriert/Zinn rustikal



**909**  
Marfil, decorada/Bronce viejo  
Ivoire, décorée/Vieux bronze  
Ivory, decorated/Old bronze  
Elfenbein, dekoriert/Antik bronziert

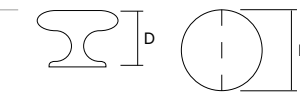

**Beo**

Porcelana-zamak / Porcelaine-zamak / Porcelain-zamak / Porzellan-Zamak

	D	E
9651	28	38
9652	26	32

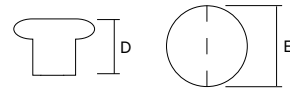

Acabado / Finition / Finish / Oberfläche



002

Blanco  
Blanc  
White  
Weiß



**Zuri**

Porcelana-zamak / Porcelaine-zamak / Porcelain-zamak / Porzellan-Zamak

	D	E
9501	28	37
9502	23	30

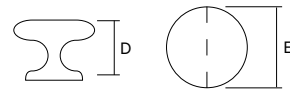

Acabado / Finition / Finish / Oberfläche



102

Blanco/Dorado brillo  
Blanc/Doré brillant  
White/Gold plated  
Weiß/Glänzend vergoldet



**Hat**

Porcelana-zamak / Porcelaine-zamak / Porcelain-zamak / Porzellan-Zamak

	D	E
9551	30	37
9552	25	30

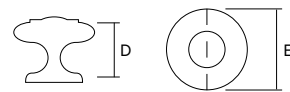

Acabado / Finition / Finish / Oberfläche



102

Blanco/Dorado brillo  
Blanc/Doré brillant  
White/Gold plated  
Weiß/Glänzend vergoldet



902

Blanco/Bronce viejo  
Blanc/Vieux bronze  
White/Old bronze  
Weiß/Antik bronziert

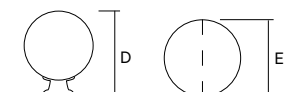

**Shine**

Cristal-latón / Cristal-laiton / Crystal-brass / Kristall-Messing

	D	E
9991	48	35
9992	42	30
9993	35	25

Acabado / Finition / Finish / Oberfläche



100

Transparente/Dorado brillo  
Transparent/Doré brillant  
Transparent/Gold plated  
Transparent/Glänzend vergoldet



400

Transparente/Cromo brillo  
Transparent/Chromé brillant  
Transparent/Bright chrome  
Transparent/Glänzend verchromt

**Lux**

Cristal "strass"-latón / Cristal "strass"-laiton / "Strass" crystal-brass / "Strass" Kristall-Messing

	D	E
9932	40	30
9933	30	25

Acabado / Finition / Finish / Oberfläche



100

Transparente/Dorado brillo  
Transparent/Doré brillant  
Transparent/Gold plated  
Transparent/Glänzend vergoldet



404

Transparente/Cromo brillo  
Transparent/Chromé brillant  
Transparent/Bright chrome  
Transparent/Glänzend verchromt

Made with Swarovski® elements

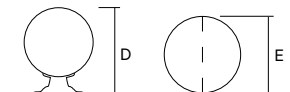

**Lux**

Cristal "strass"-latón / Cristal "strass"-laiton / "Strass" crystal-brass / "Strass" Kristall-Messing

	D	E
9952	26	30
9953	23	25

Acabado / Finition / Finish / Oberfläche



100

Transparente/Dorado brillo  
Transparent/Doré brillant  
Transparent/Gold plated  
Transparent/Glänzend vergoldet



404

Transparente/Cromo brillo  
Transparent/Chromé brillant  
Transparent/Bright chrome  
Transparent/Glänzend verchromt

Made with Swarovski® elements

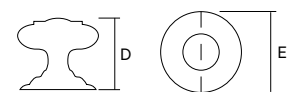



**Patch**

Nylon

	B	C	D
5611	40	40	20

Acabado / Finition / Finish / Oberfläche



000

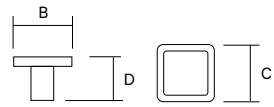

**Patch**

Nylon

	B	C	D
5612	40	40	20

Acabado / Finition / Finish / Oberfläche



000

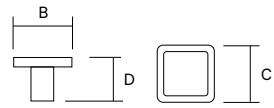

**Clover**

Nylon

	B	C	D
5613	43	43	20

Acabado / Finition / Finish / Oberfläche



000



**Flower**

Nylon

	B	C	D
5614	50	50	20

Acabado / Finition / Finish / Oberfläche



000

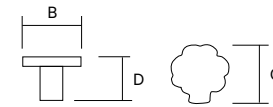
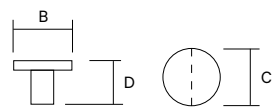

**Tree**

Nylon

	B	C	D
5615	47	51	20

Acabado / Finition / Finish / Oberfläche



000

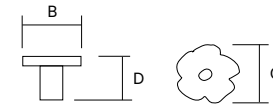

**Rose**

Nylon

	B	C	D
5616	50	50	20

Acabado / Finition / Finish / Oberfläche



000

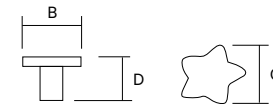

**Star**

Nylon

	B	C	D
5617	50	50	20

Acabado / Finition / Finish / Oberfläche



000

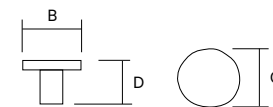

**Heart**

Nylon

	B	C	D
5618	50	48	20

Acabado / Finition / Finish / Oberfläche



000

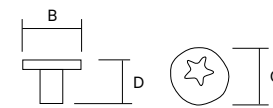

**Whitestar**

Nylon

	B	C	D
5619	50	50	20

Acabado / Finition / Finish / Oberfläche



000

**Elephant**

Nylon

	B	C	D
5621	41	44	20

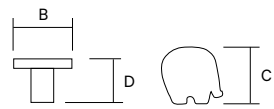
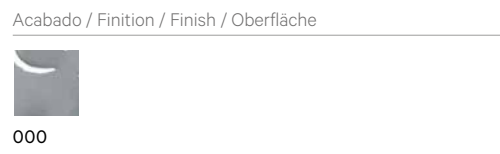

**Bear**

Nylon

	B	C	D
5622	38	47	20

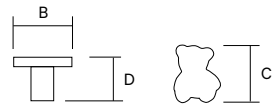
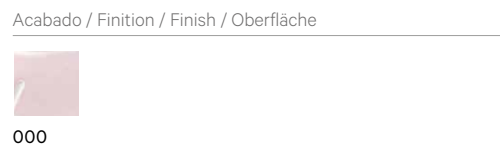

**Bunny**

Nylon

	B	C	D
5623	35	58	20

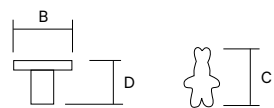
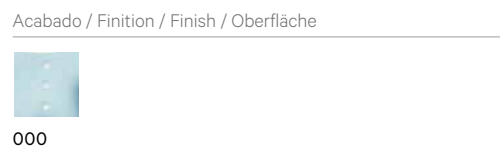

**Butterfly**

Nylon

	B	C	D
5624	45	42	20

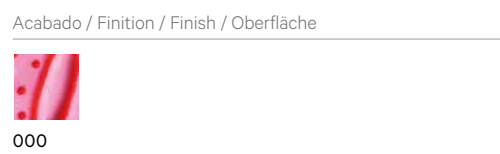

**Frog**

Nylon

	B	C	D
5625	51	35	20

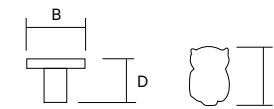
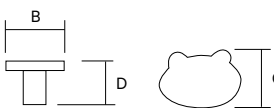
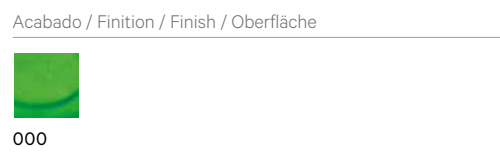

**Owl**

Nylon

	B	C	D
5626	34	49	20

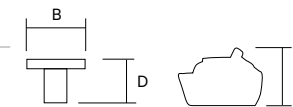
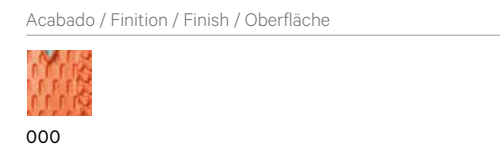

**Ship**

Nylon

	B	C	D
5627	50	35	20

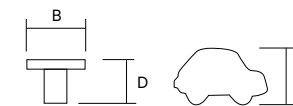
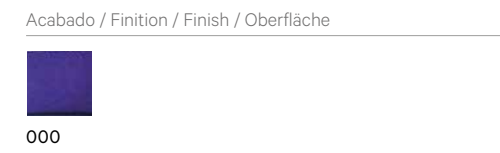

**Car**

Nylon

	B	C	D
5628	50	31	20

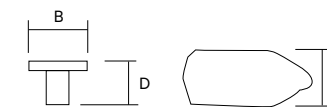
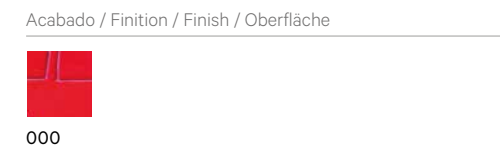

**Pencil**

Nylon

	B	C	D
5629	51	23	20

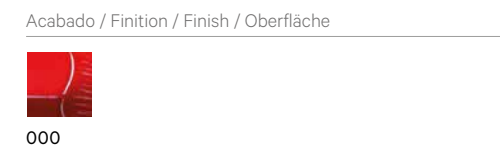



**Unix Duo**

Acero inoxidable-zamak / Acier inox-zamak / Stainless steel-zamak / Rostfreier Stahl-Zamak

	A	B	C	D
7511	320	333	25	38
7512	256	269	25	38
7513	192	205	25	38

Acabado / Finition / Finish / Oberfläche



031

Inoxidable cepillado  
Inox brossé  
Brushed stainless  
Rostfreier Stahl, gebürstet

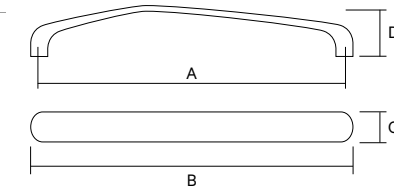
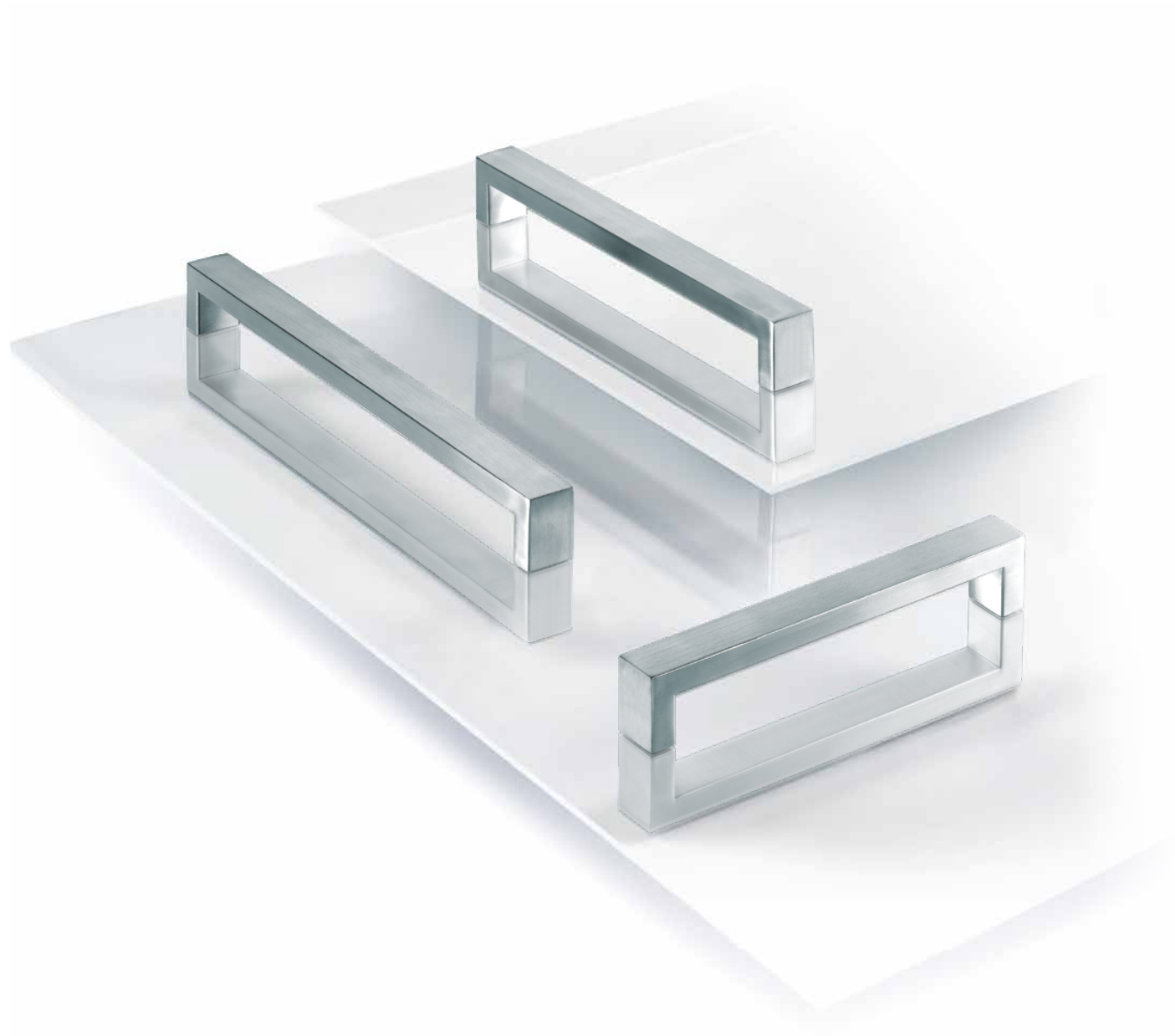
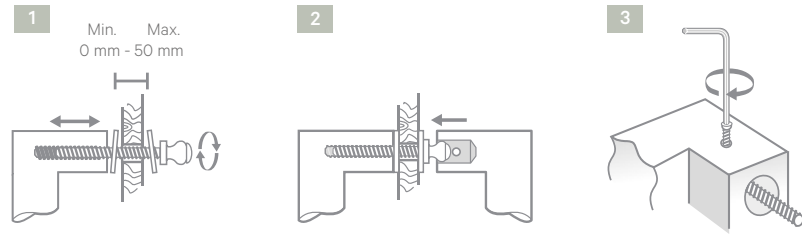
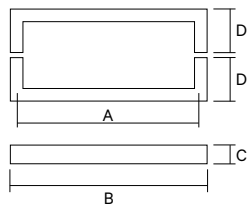

**Grip**

Zamak

	A	B	C	D
2211	300	317	25	52
2212	200	217	25	48

Acabado / Finition / Finish / Oberfläche



038

Níquel cepillado  
Nickelé brossé  
Brushed Nickel  
Gebürstetes Nickel



400

Cromo brillo  
Chromé brillant  
Bright chrome  
Glänzend verchromt

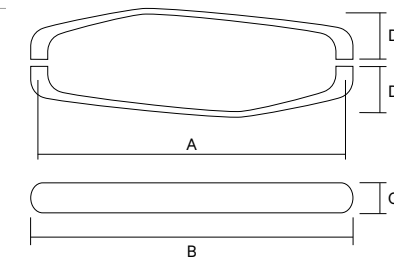
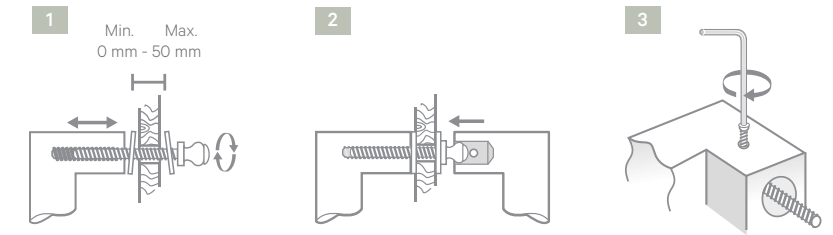

**Grip**

Zamak

	A	B	C	D
2111	300	317	25	52
2112	200	217	25	48

Acabado / Finition / Finish / Oberfläche



038

Níquel cepillado  
Nickelé brossé  
Brushed Nickel  
Gebürstetes Nickel



400



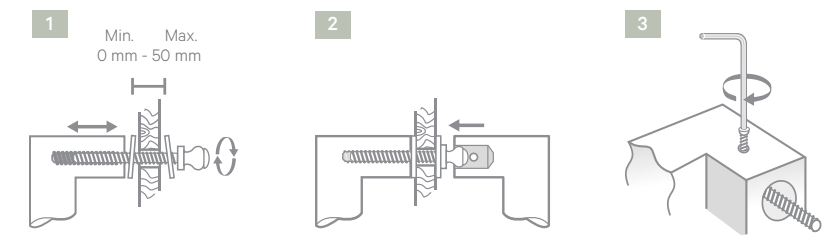

Cromo brillo  
Chromé brillant  
Bright chrome  
Glänzend verchromt



**Bolt**

Zamak	A	B	C	D	E	F	G
2000	140	69	45	22	22	19	32

Acabado / Finition / Finish / Oberfläche

- |   |   |  |
|---|---|--|
|   |      |     |
| <b>100</b><br>Dorado brillo<br>Doré brillant<br>Gold plated<br>Glänzend vergoldet | <b>200</b><br>Dorado satinado<br>Doré satiné<br>Satin gold plated<br>Satiniertes gold | <b>400</b><br>Cromo brillo<br>Chromé brillant<br>Bright chrome<br>Glänzend verchromt |
|   |      |  |
| <b>800</b><br>Cromo mate<br>Chromé mat<br>Dull chrome<br>Matt verchromt           | <b>900</b><br>Bronce viejo<br>Vieux bronze<br>Old bronze<br>Antik bronziert           |  |

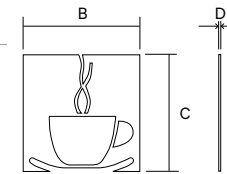
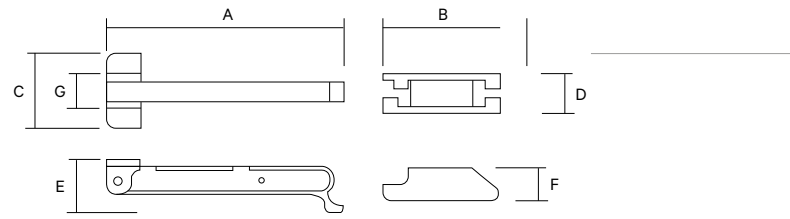

**Icons**

Acero inoxidable-zamak / Acier inox-zamak / Stainless steel-zamak / Rostfreier Stahl-Zamak

	B	C	D
1101	100	100	2

Acabado / Finition / Finish / Oberfläche

- |   |   |
|---|---|
|  | Inoxidable cepillado<br>Inox brossé<br>Brushed stainless<br>Rostfreier Stahl, gebürstet |
| <b>031</b>  |   |

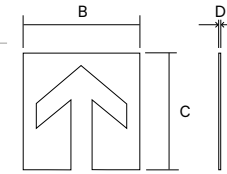

**Icons**

Acero inoxidable-zamak / Acier inox-zamak / Stainless steel-zamak / Rostfreier Stahl-Zamak

	B	C	D
1102	100	100	2

Acabado / Finition / Finish / Oberfläche

- |   |   |
|---|---|
|  | Inoxidable cepillado<br>Inox brossé<br>Brushed stainless<br>Rostfreier Stahl, gebürstet |
| <b>031</b>  |   |

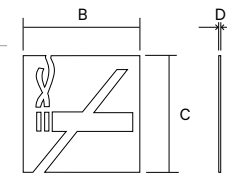

**Icons**

Acero inoxidable-zamak / Acier inox-zamak / Stainless steel-zamak / Rostfreier Stahl-Zamak

	B	C	D
1103	100	100	2

Acabado / Finition / Finish / Oberfläche

- |   |   |
|---|---|
|  | Inoxidable cepillado<br>Inox brossé<br>Brushed stainless<br>Rostfreier Stahl, gebürstet |
| <b>031</b>  |   |

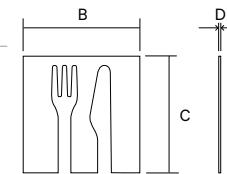

**Icons**

Acero inoxidable-zamak / Acier inox-zamak / Stainless steel-zamak / Rostfreier Stahl-Zamak

	B	C	D
1104	100	100	2

Acabado / Finition / Finish / Oberfläche

- |   |   |
|---|---|
|  | Inoxidable cepillado<br>Inox brossé<br>Brushed stainless<br>Rostfreier Stahl, gebürstet |
| <b>031</b>  |   |

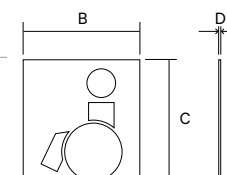
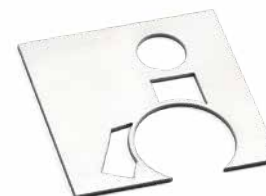

**Icons**

Acero inoxidable-zamak / Acier inox-zamak / Stainless steel-zamak / Rostfreier Stahl-Zamak

	B	C	D
1105	100	100	2

Acabado / Finition / Finish / Oberfläche

- |   |   |
|---|---|
|  | Inoxidable cepillado<br>Inox brossé<br>Brushed stainless<br>Rostfreier Stahl, gebürstet |
| <b>031</b>  |   |



**Icons**

Acero inoxidable-zamak / Acier inox-zamak / Stainless steel-zamak / Rostfreier Stahl-Zamak

	B	C	D
1106	100	100	2

Acabado / Finition / Finish / Oberfläche

 Inoxidable cepillado  
Inox brossé  
Brushed stainless  
Rostfreier Stahl, gebürstet

031

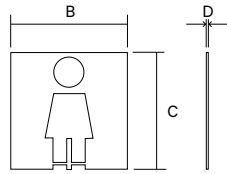

**Icons**

Acero inoxidable-zamak / Acier inox-zamak / Stainless steel-zamak / Rostfreier Stahl-Zamak

	B	C	D
1107	100	100	2

Acabado / Finition / Finish / Oberfläche

 Inoxidable cepillado  
Inox brossé  
Brushed stainless  
Rostfreier Stahl, gebürstet

031

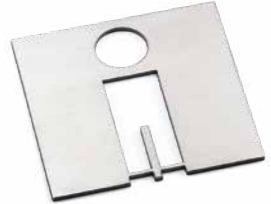
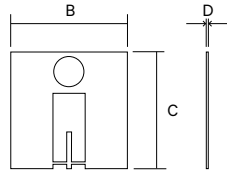

**Icons**

Acero inoxidable-zamak / Acier inox-zamak / Stainless steel-zamak / Rostfreier Stahl-Zamak

	B	C	D
1108	100	100	2

Acabado / Finition / Finish / Oberfläche

 Inoxidable cepillado  
Inox brossé  
Brushed stainless  
Rostfreier Stahl, gebürstet

031

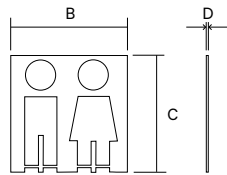

**Icons**

Acero inoxidable-zamak / Acier inox-zamak / Stainless steel-zamak / Rostfreier Stahl-Zamak

	B	C	D
1109	100	100	2

Acabado / Finition / Finish / Oberfläche

 Inoxidable cepillado  
Inox brossé  
Brushed stainless  
Rostfreier Stahl, gebürstet

031

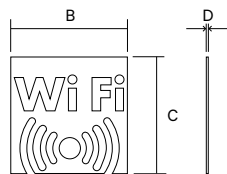

Instalación con cinta adhesiva de doble cara incluida en el blister.  
Installation avec ruban adhésif double-face inclu dans le blister.  
Installation with double sided adhesive tape included in blister.  
Montage mittels doppelseitigem Klebeband, im Blister enthalten.

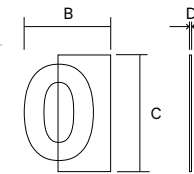
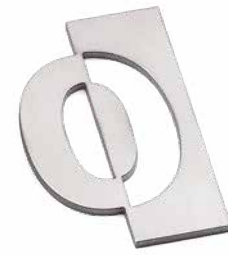

**Icons**

Acero inoxidable-zamak / Acier inox-zamak / Stainless steel-zamak / Rostfreier Stahl-Zamak

	B	C	D
1000	80	125	2
1020	20	75	2

Acabado / Finition / Finish / Oberfläche

 Inoxidable cepillado  
Inox brossé  
Brushed stainless  
Rostfreier Stahl, gebürstet

031

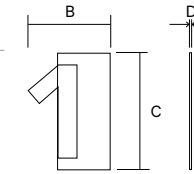
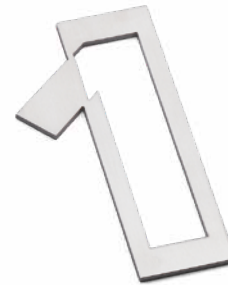

**Icons**

Acero inoxidable-zamak / Acier inox-zamak / Stainless steel-zamak / Rostfreier Stahl-Zamak

	B	C	D
1001	60	125	2
1021	30	75	2

Acabado / Finition / Finish / Oberfläche

 Inoxidable cepillado  
Inox brossé  
Brushed stainless  
Rostfreier Stahl, gebürstet

031

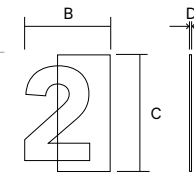

**Icons**

Acero inoxidable-zamak / Acier inox-zamak / Stainless steel-zamak / Rostfreier Stahl-Zamak

	B	C	D
1002	80	125	2
1022	20	75	2

Acabado / Finition / Finish / Oberfläche

 Inoxidable cepillado  
Inox brossé  
Brushed stainless  
Rostfreier Stahl, gebürstet

031

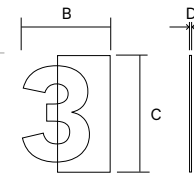

**Icons**

Acero inoxidable-zamak / Acier inox-zamak / Stainless steel-zamak / Rostfreier Stahl-Zamak

	B	C	D
1003	80	125	2
1023	20	75	2

Acabado / Finition / Finish / Oberfläche

 Inoxidable cepillado  
Inox brossé  
Brushed stainless  
Rostfreier Stahl, gebürstet

031

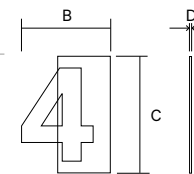
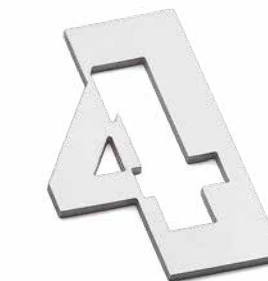

**Icons**

Acero inoxidable-zamak / Acier inox-zamak / Stainless steel-zamak / Rostfreier Stahl-Zamak

	B	C	D
1004	80	125	2
1024	20	75	2

Acabado / Finition / Finish / Oberfläche

 Inoxidable cepillado  
Inox brossé  
Brushed stainless  
Rostfreier Stahl, gebürstet

031

**Icons**

Acero inoxidable-zamak / Acier inox-zamak / Stainless steel-zamak / Rostfreier Stahl-Zamak

	B	C	D
1005	80	125	2
1025	20	75	2

Acabado / Finition / Finish / Oberfläche

 Inoxidable cepillado  
Inox brossé  
Brushed stainless  
Rostfreier Stahl, gebürstet

031

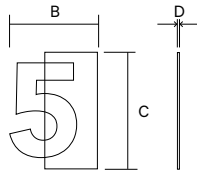

**Icons**

Acero inoxidable-zamak / Acier inox-zamak / Stainless steel-zamak / Rostfreier Stahl-Zamak

	B	C	D
1006	80	125	2
1026	20	75	2

Acabado / Finition / Finish / Oberfläche

 Inoxidable cepillado  
Inox brossé  
Brushed stainless  
Rostfreier Stahl, gebürstet

031

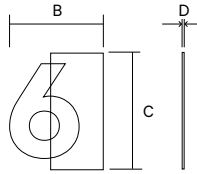

**Icons**

Acero inoxidable-zamak / Acier inox-zamak / Stainless steel-zamak / Rostfreier Stahl-Zamak

	B	C	D
1007	80	125	2
1027	20	75	2

Acabado / Finition / Finish / Oberfläche

 Inoxidable cepillado  
Inox brossé  
Brushed stainless  
Rostfreier Stahl, gebürstet

031

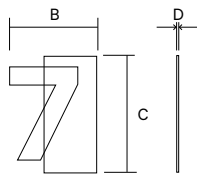

**Icons**

Acero inoxidable-zamak / Acier inox-zamak / Stainless steel-zamak / Rostfreier Stahl-Zamak

	B	C	D
1008	80	125	2
1028	20	75	2

Acabado / Finition / Finish / Oberfläche

 Inoxidable cepillado  
Inox brossé  
Brushed stainless  
Rostfreier Stahl, gebürstet

031

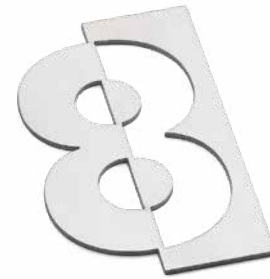
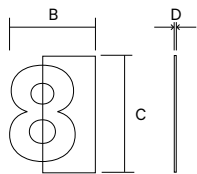

**Icons**

Acero inoxidable-zamak / Acier inox-zamak / Stainless steel-zamak / Rostfreier Stahl-Zamak

	B	C	D
1009	80	125	2
1029	20	75	2

Acabado / Finition / Finish / Oberfläche

 Inoxidable cepillado  
Inox brossé  
Brushed stainless  
Rostfreier Stahl, gebürstet

031

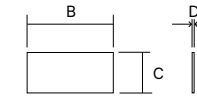
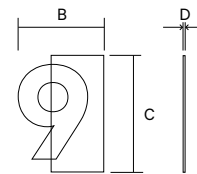

**Icons**

Acero inoxidable-zamak / Acier inox-zamak / Stainless steel-zamak / Rostfreier Stahl-Zamak

	B	C	D
1030	20	10	2

Acabado / Finition / Finish / Oberfläche

 Inoxidable cepillado  
Inox brossé  
Brushed stainless  
Rostfreier Stahl, gebürstet

031

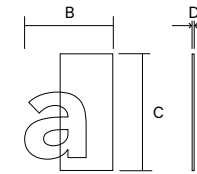

**Icons**

Acero inoxidable-zamak / Acier inox-zamak / Stainless steel-zamak / Rostfreier Stahl-Zamak

	B	C	D
102A	40	75	2

Acabado / Finition / Finish / Oberfläche

 Inoxidable cepillado  
Inox brossé  
Brushed stainless  
Rostfreier Stahl, gebürstet

031

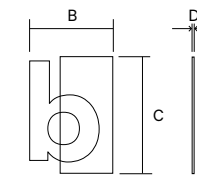

**Icons**

Acero inoxidable-zamak / Acier inox-zamak / Stainless steel-zamak / Rostfreier Stahl-Zamak

	B	C	D
102B	40	75	2

Acabado / Finition / Finish / Oberfläche

 Inoxidable cepillado  
Inox brossé  
Brushed stainless  
Rostfreier Stahl, gebürstet

031



En blister packs con elementos de fijación incluidos.  
Dans des blisters, tous les éléments de fixation inclus.  
In blisters, all fitting elements included.  
In Blisterverpackung, Befestigungselemente eingeschlossen.

Instalación con cinta adhesiva de doble cara incluida en el blister.  
Installation avec ruban adhésif double-face inclus dans le blister.  
Installation with double sided adhesive tape included in blister.  
Montage mittels doppelseitigem Klebeband, im Blister enthalten.



Montaje para números de 125mm  
Montage pour numéros de 125mm  
Set up for numbers 125mm  
Befestigungsanleitung von Ziffern in 125mm



**Icons**

Acero inoxidable-zamak / Acier inox-zamak / Stainless steel-zamak / Rostfreier Stahl-Zamak

	B	C	D
102C	40	75	2

Acabado / Finition / Finish / Oberfläche

 Inoxidable cepillado  
Inox brossé  
Brushed stainless  
Rostfreier Stahl, gebürstet

031

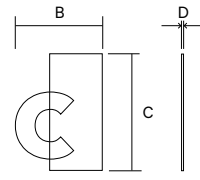

**Icons**

Acero inoxidable-zamak / Acier inox-zamak / Stainless steel-zamak / Rostfreier Stahl-Zamak

	B	C	D
102D	40	75	2

Acabado / Finition / Finish / Oberfläche

 Inoxidable cepillado  
Inox brossé  
Brushed stainless  
Rostfreier Stahl, gebürstet

031

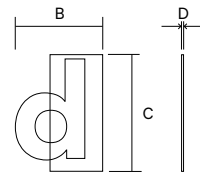

**Icons**

Acero inoxidable-zamak / Acier inox-zamak / Stainless steel-zamak / Rostfreier Stahl-Zamak

	B	C	D
102E	40	75	2

Acabado / Finition / Finish / Oberfläche

 Inoxidable cepillado  
Inox brossé  
Brushed stainless  
Rostfreier Stahl, gebürstet

031

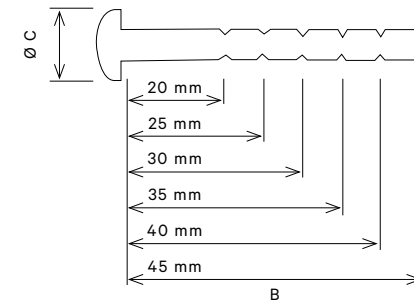
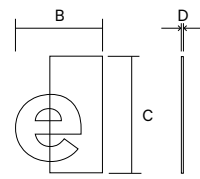

**Tornillo multilargo  
Vis multilongueur  
Multisize screw  
Multilängen-Schrauben**

Hierro / Fer / Iron / Eisen

	A	B	C	D
M-45		20-45	9	

Acabado / Finition / Finish / Oberfläche



000  
Zincado  
Zingué  
Zinc  
Verzinkt

Tornillo multilargo de corte limpio que siempre rosca. Nuestros herrajes Estamp llevan incorporados este tipo de tornillo. Vis multilongueur qui se coupe facilement sans abîmer le filetage. Nos articles Estamp portent tous ce type de vis. Multisize screw clean cut that always screws. Our Estamp fittings include this kind of screw. Multilängenschraube immer gängig dank dem sauberen gewindeschnitt. Unsere Estamp Möbelbeschläge werden mit diesem Schraubentyp geliefert.

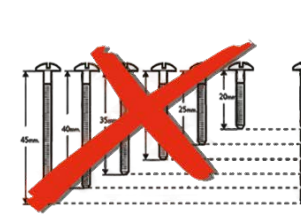

✓ **Reduzca la inversión**  
En inmovilizado y el riesgo de restos invendibles sustituyendo los tornillos de diversas longitudes por el tornillo multilargo Estamp.

✓ **Reduisez l'investissement**  
Des stocks immobilisés et le risque d'invendus en remplaçant les vis de différentes longueurs par une seule vis multilongueur Estamp.

✓ **Reduce investment**  
In stocks and risk of not saleable rests substituting screws of different lengths with Estamp multisize screw.

✓ **Reduzieren sie Ihre Investitionen**  
In Anlagen und vermeiden Sie das Risiko, auf unverkäuflichen Resten sitzen zu bleiben. Verwenden Sie anstatt Schrauben verschiedener Längen die Estamp Multilängen-schraube.



✓ **Reduzca espacio**  
De almacenaje manteniendo en stock una sola longitud de tornillo.

✓ **Reduisez le volume**  
De stockage en disposant d'une seule longueur de vis.

✓ **Reduce Space**  
For storage keeping only one length of screw.

✓ **Geringerer Lager-Platzbedarf**  
Dank einer einzigen Schraubenlänge.

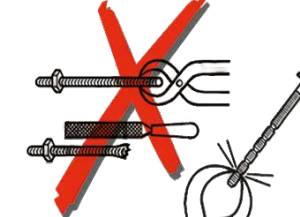

✓ **Reduzca el gasto**  
En mano de obra eliminando el limado de espárragos tradicionales al utilizar el tornillo multilargo Estamp de corte limpio y roscado directo.

✓ **Reduisez les frais**  
De main-d'oeuvre pour le limage des tiges traditionnelles en utilisant la vis Estamp multilongueur de coupe facile et directe vis.

✓ **Reduce expenses**  
On labour eliminating filing of traditional screw by using multisize Estamp screws of clean cut and direct screw.

✓ **Reduzieren sie Ihre Lohkosten**  
Die sauber geschnittene, direktgängige Estamp Multilängenschraube macht das herkömmliche Steh-schraubenfeilen überflüssig.

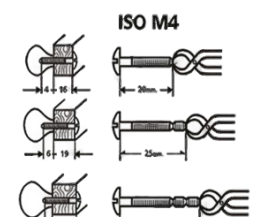

✓ **Adaptable**  
A los gruesos de madera utilizados en carpintería y ebanistería. Nuestros herrajes Estamp llevan incorporados este tipo de tornillo.

✓ **Adaptable**  
À toutes les épaisseurs de bois utilisés en menuiserie et en ébénisterie. Nos articles Estamp portent tous ce type de vis.

✓ **Adaptable**  
To different thicknesses of wood used in carpentry and woodwork industry. Our fittings Estamp are fitted with this kind of screw.

✓ **Anpassungsfähig**  
Für alle in der Tischlerei und Schreinerei gebräuchlichen Holzdicken geeignet. Unsere Estamp Möbelbeschläge werden mit diesem Schraubentyp geliefert.

## Cierres a presión Fermetures à pression Pressure locks Druckverschlüsse

Nylon

231	Para puertas grandes / Pour grandes portes / For large doors / Für grosse Türen
232	Para puertas pequeñas / Pour petites portes / For small doors / Für kleine Türen

Acabado / Finition / Finish / Oberfläche



000

Nylon  
Nylon  
Nylon  
Nylon

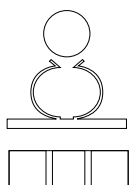

## Tornillos Vis Screws Schrauben

Hierro / Fer / Iron / Eisen

	A	B	C	D
T-14		14	9	
T-21		21	9	
T-25		25	9	
T-31		31	9	
T-35		35	9	
T-40		40	9	
T-60		60	9	

Acabado / Finition / Finish / Oberfläche



000

Bicromatado  
Bichromaté  
Zinc-yellow  
Bichromatiert

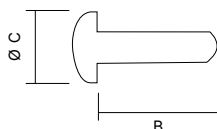

## Espárrago rosca madera Tiges filetéés pour bois Wood screw Gewindeschraube für Holz

Hierro / Fer / Iron / Eisen

	A	B	C	D
ED-15	22			

Acabado / Finition / Finish / Oberfläche



000

Bicromatado  
Bichromaté  
Zinc-yellow  
Bichromatiert

